



Switching Power Supplies  
PS3V



# Compact & Reliable Power Supplies

Flexible installation allows mounting in four directions



IDEC CORPORATION

# Suitable for **downsizing** of equipm

## Compact & efficient **switching power supplies**

**Compact**

Suitable for downsizing of equipment  
(Image: 15W type)  
**Compact size**

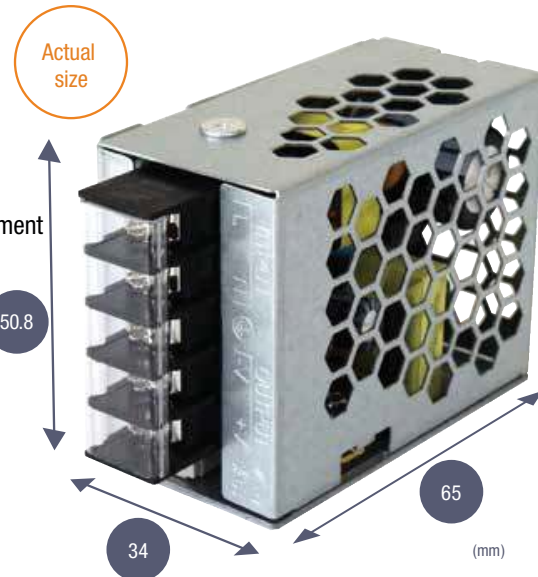

**Operating Temperature**

Operates in a wide temperature range from  $-25$  to  $+70^{\circ}\text{C}$ . Suitable for use in a wide temperature range from cold to hot environment.



**Wide temperature range**

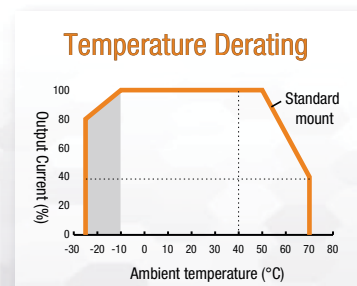

**Push-in connection**

One step wiring.  
Safe and efficient push-in connection.

\*Push-in models available in summer 2021.



### Applications

Warehouse storage

Control panels in facilities such as buildings

As a manufacturer of factory automation products,

we provide total solutions and related PLCs & HMI products



Operates in temperatures ranging from  $-25$  to  $+70^{\circ}\text{C}$ . Ideal for use in various storage facilities such as freezers and refrigerators.



Complies with safety standards for various facilities other than factories.

# ment

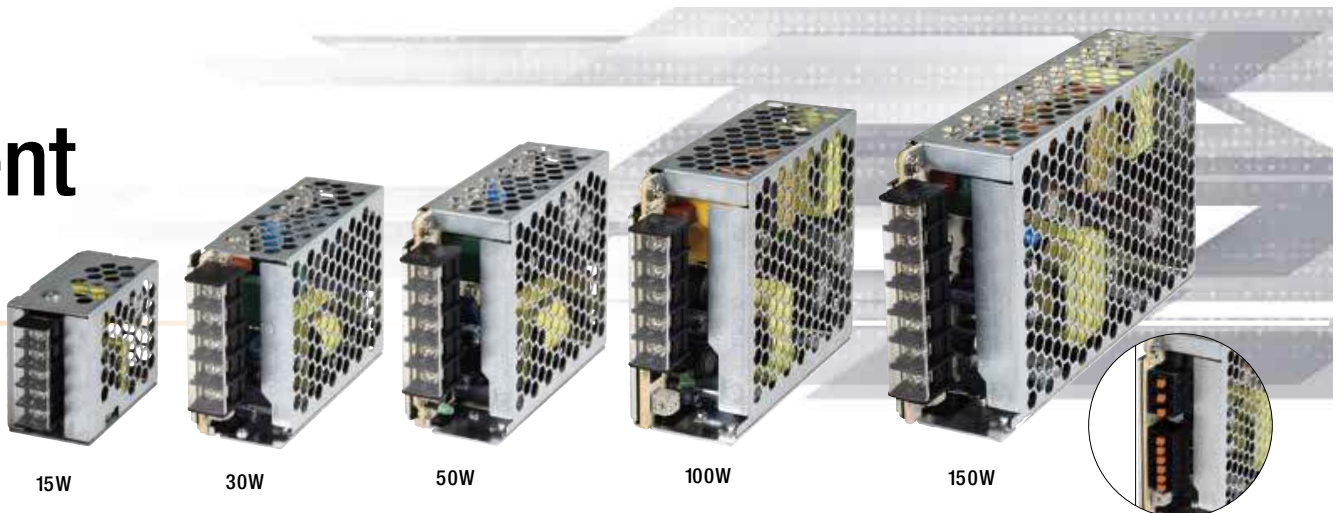

\*Push-in terminal types also available. (except 15W)

## + Safety Standards

Suitable for global use and various industries.



## 5 Warranty period 5 years

Conditions apply to:  
Operating temperature 40°C, load rate 60%, standard mount  
For details on warranty, see page 11.

## + Easy access

QR codes are printed on the product enabling easy access to the latest instruction manuals.



## + Mounting examples

### Direct mount



When PS3V-050AF is mounted (standard mount) with PS9Z-3E3B mounting bracket

### DIN rail mount



When PS3V-030AF is mounted (standard mount) with PS9Z-3E3C mounting bracket

## + Flexible mounting

Mounts in 4-directions

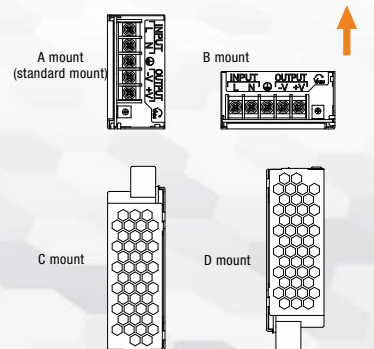

Safety equipment at station platforms



Vibration-resistant and maintenance-free (no retightening of screws). Push-in improves efficiency in limited spaces.

Control panels at plant factories



IDEC's reliable technology enable stable power supply and its compact size allows installation in small equipment.

Other examples

- Machine tools
- Semiconductor manufacturing equipment
- Mold injection machines
- Food and packaging machines
- Multilevel parking garage
- Car facilities
- Logistics and transport facilities
- Agricultural facilities
- Energy-related facilities, others

# PS3V Switching Power Supplies

## PS3V

Package quantity: 1

Output capacity	Horizontal terminal type	Push-in terminal type (*1)	Input voltage	Output voltage	Output current
	Part no.	Part no.			
15W	PS3V-015AF05C	—	100 to 240V AC	5V	3.0A
	PS3V-015AF12C	—		12V	1.3A
	PS3V-015AF24C	—		24V	0.63A
30W	PS3V-030AF05C	PS3V-030AF05P		5V	6.0A
	PS3V-030AF12C	PS3V-030AF12P		12V	2.5A
	PS3V-030AF24C	PS3V-030AF24P		24V	1.3A
50W	PS3V-050AF12C	PS3V-050AF12P		12V	4.5A
	PS3V-050AF24C	PS3V-050AF24P		24V	2.3A
100W	PS3V-100AF24C	PS3V-100AF24P		24V	4.5A
150W	PS3V-150AF24C	PS3V-150AF24P		24V	6.5A

\*1) Push-in models available in June 2021

### Part no. configuration

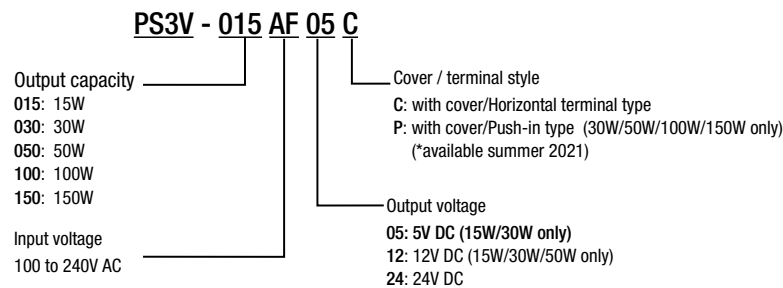

### Accessories





Name	Applicable model	Part no. (Ordering no.)	Package quantity	Remarks
L-shaped mounting bracket (*2)	PS3V-015AF	PS9Z-3N3A	1	L-shaped mounting brackets for PS3X switching power supplies can be used.
	PS3V-030AF	PS9Z-3E3B		
	PS3V-050AF			
	PS3V-100AF			
DIN rail mounting bracket	PS3V-015AF	PS9Z-3N4B	1	DIN rail mounting brackets for PS3X power supplies can be used.
	PS3V-030AF	PS9Z-3E4C		
	PS3V-050AF			
	PS3V-100AF			
	PS3V-150AF	PS9Z-3E4D		

\*2) PS3X L-shaped mounting brackets (PS9Z-3N3B) cannot be used.

L-shaped mounting bracket is not available for PS3V-150AF. PS9Z-3N3B L-shaped mounting brackets cannot be used for PS3V-150AF.

### DIN rail/End clip/Tools

Specify the Ordering no. when ordering.

Name	Part No.	Ordering No.	Package quantity	Remarks
35mm DIN rail	BAA1000	BAA1000PN10	10	Material: Aluminum Weight: 200g Length: 1,000mm
End clip	BNL5	BNL5PN10	10	Weight: 15g Material: Steel Plating: Trivalent zinc chromate M4 screw used
	BNL6	BNL6PN10		Weight: 15.2g Material: Steel Plating: Trivalent zinc chromate M4 screw used
Crimping tool (for ferrules)		S3TL-CR06D	1	Applicable ferrule: With/without insulated cover Crimping shape 
Auto-adjust stripping tool		S3TL-ST06	1	PVC-insulated thin stranded and solid wires 0.08 to 6mm <sup>2</sup> (28AWG to 10AWG)
Insulated driver		S3TL-D04-25-75	1	Blade size (dimensions: mm) 

### Specifications

Item		Part no.	[15W] PS3V-015AF 05C / 12C / 24C	[30W] PS3V-030AF 05□ / 12□ / 24□	[50W] PS3V-050AF 12□ / 24□	[100W] PS3V-100AF24□	[150W] PS3V-150AF24□
Input conditions	Rated input voltage	100 to 240V AC					
	(Voltage range) (*1)	85 to 264V AC (Single phase 2 wire)					
	Frequency	47 to 63Hz					
	Input current (at rated output)	100V: 0.32A (typ) 230V: 0.2A (typ)	100V: 0.66A (typ) 230V: 0.35A (typ)	100V: 1.1A (typ) 230V: 0.6A (typ)	100V: 1.3A (typ) 230V: 0.6A (typ)	100V: 1.9A (typ) 230V: 0.9A (typ)	
	Inrush current (Ta = 25°, cold start)	at 100V AC	40A typ.	18A typ.	18A typ.	18A typ.	18A typ.
		at 230V AC	60A typ.	45A typ.	45A typ.	45A typ.	45A typ.
	Leakage current	120V: 0.5mA max., 240V: 1mA max.					
	Efficiency (TYP.) (at rated output)	5V	77% (100VAC) 76% (230VAC)	77% (100VAC) 77% (230VAC)	–	–	–
		12V	82% (100VAC) 81% (230VAC)	83% (100VAC) 83% (230VAC)	84% (100VAC) 84% (230VAC)	–	–
		24V	84% (100VAC) 83% (230VAC)	85% (100VAC) 84% (230VAC)	87% (100VAC) 87% (230VAC)	85% (100VAC) 88% (230VAC)	85% (100VAC) 88% (230VAC)
Power factor (TYP.) (at rated output)		–	–	–	0.98 (100V AC) 0.9 (230V AC)	0.98 (100V AC) 0.95 (230V AC)	
Output conditions	Output voltage/Current	5V / 3A	5V / 6A	–	–	–	
		12V / 1.3A	12V / 2.5A	12V / 4.5A	–	–	
		24V / 0.63A	24V / 1.3A	24V / 2.3A	24V / 4.5A	24V / 6.5A	
	Adjustable voltage range	±10% (Front, adjustable using V.ADJ volume)					
	Output holding time (at rated output)	5V	15ms typ. (100V AC)	–	–	–	–
		12V	120ms typ. (230V AC)	18ms typ. (100V AC)	–	–	–
		24V	20ms typ. (100V AC) 130ms typ. (230V AC)	110ms typ. (230V AC)	17ms typ. (100V AC) 125ms typ. (230V AC)	35ms typ. (100V AC) 35ms typ. (230V AC)	24ms typ. (100V AC) 24ms typ. (230V AC)
	Start time	650ms max. (at rated input/output)					
	Rise Time	300ms max. (at rated input/output)		200ms max. (at rated input/output)			
	Constant voltage accuracy	Input fluctuation	0.4% max.				
Load fluctuation		1% max.					
Temperature fluctuation		0.05%/°C max. (–10 to +50°C)					
Ripple (including noise)		–25 to –10°C	5V: 8%p-p max. 12V: 6%p-p max. 24V: 4%p-p max.	5V: 8%p-p max. 12V: 6%p-p max. 24V: 4%p-p max.	12V: 6%p-p max. 24V: 4%p-p max.	24V: 4%p-p max.	
		–10 to 0°C	5V: 5%p-p max. 12V: 2.5%p-p max. 24V: 1.5%p-p max.	5V: 5%p-p max. 12V: 2.5%p-p max. 24V: 1.5%p-p max.	12V: 2.5%p-p max. 24V: 1.5%p-p max.	24V: 1.5%p-p max.	
		0 to 50°C	5V: 2.5%p-p max. 12V: 1.5%p-p max. 24V: 1%p-p max.	5V: 2.5%p-p max. 12V: 1.5%p-p max. 24V: 1%p-p max.	12V: 1.5%p-p max. 24V: 1%p-p max.	24V: 1%p-p max.	
Supplementary functions	Overcurrent protection	105% min. (auto reset) (*2)					
	Overvoltage protection	120% min. (intermittent, auto reset)	Output off at 120% min, reset when re-input				
	Operation indicator	LED (green)					
Dielectric strength	Between input and output terminals	3000V AC, 1 minute					
	Between input and ground terminals	2000V AC, 1 minute					
	Between output and ground terminals	500V AC, 1 minute					
Insulation resistance	100MΩ min. 500V DC megger (at 25°C, 70% RH) (between input and output terminals, between input and ground terminals)						
Operating temperature	–25 to +70°C, (no freezing, output derating available)						
Operating humidity	20 to 90% RH (no condensation)						
Storage temperature	–25 to +75°C (no freezing)						
Storage humidity	20 to 90% RH (no condensation)						
Vibration resistance	10 to 55 Hz, 2G constant, 2 hours each in 3 axes						
Shock resistance	200M/s <sup>2</sup> , 11ms, 1 shock each in 6 axes						
Expected life (reference value) (*3)	8 years min. (rated input, load factor 50%, operating temperature +40°C, standard mounting)						
EMC	EMI	EN61204-3 Class B					
	EMS	EN61204-3 (Industrial)					
Safety standards	EN62368-1 (TÜV), IEC 62368-1 UL61010-1, UL61010-2-201, CSA C22.2 No.61010-1, CSA C22.2 No.61010-2-201 (Listing, SELV *all models pending) UL62368-1, CSA C22.2 No.62368-1-14 (Recognition)						
Dimensions (mm) (terminal part except protrusion)	50.8H×34W×65D	68.5H×34.5W×95.5D	80H×36W×99D	93H×39W×108D	95H×39W×159D		
Weight (approx.)	135g	190g	230g	380g	510g		
Terminal screw (horizontal type)	M3	M3.5					

\*1) Not subjected to safety standards. Output delay also available.

\*2) If overload continues for over 30 seconds, the internal elements may be damaged.

PS3V-015AF is equipped with a thermal shutdown function. When thermal shutdown operates, auto reset does not function until the temperature inside the power supply drops.

\*3) Calculation of the expected life is based on the actual life of the aluminum electrolytic capacitor.

The expected life depends on operating conditions.

**PS3V Switching Power Supplies**

**Block diagram**

**PS3V-015AF**

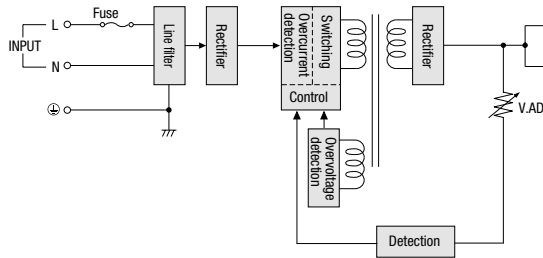

**PS3V-030AF, PS3V-050AF**

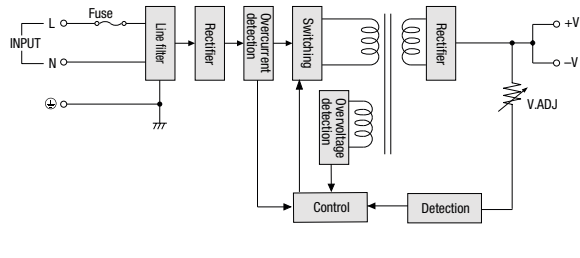

**PS3V-100AF, PS3V-150AF**

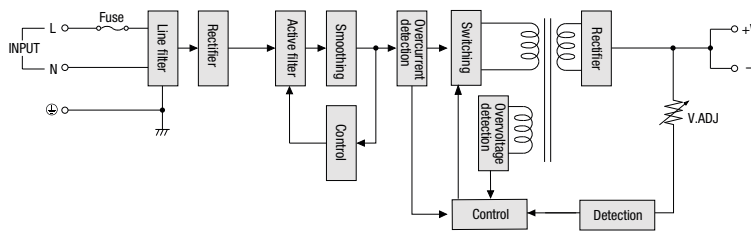

**Characteristics**

**Output current - Operating temperature characteristics (Output derating)**

\*Conditions: Natural air cooling (operating temperature is the temperature around the power supply)

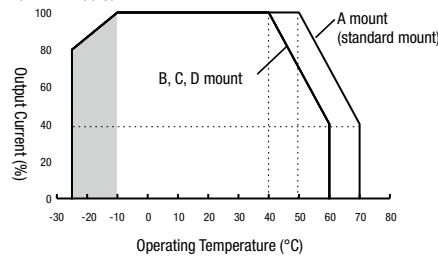

• Areas indicated with may take time for the output voltage to stabilize.

**Overcurrent protection characteristics**

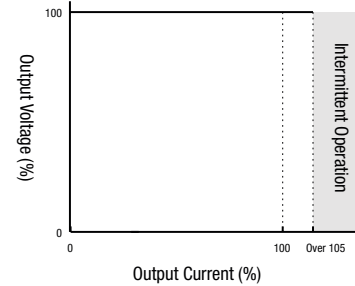

**Output current - Input voltage characteristics (Output derating) (Ta=25°C)**

**PS3V-015AF / -030AF**

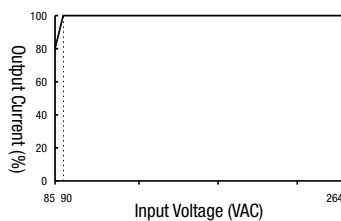

**PS3V-050AF**

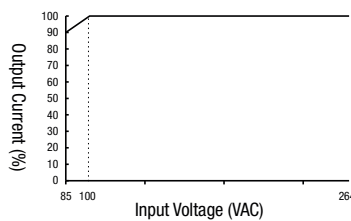

**PS3V-100AF / -150AF**

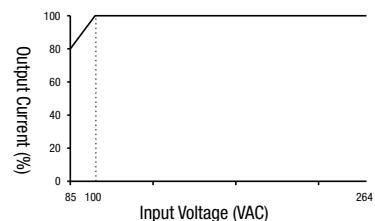

**Operating temperature by safety standards**

UL / c-UL / TÜV	A mount	50°C
	B mount	40°C

**Mounting direction**

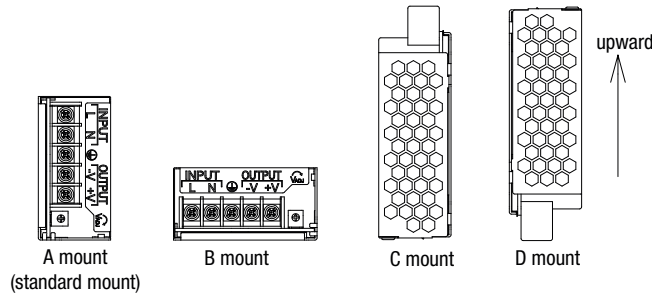

**Parts Description**

Note) Note the terminal arrangement when wiring.

**Horizontal terminal type**

PS3V-015AF

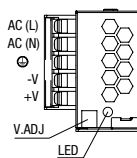

PS3V-030AF

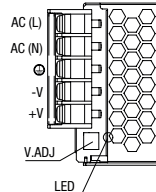

PS3V-050AF

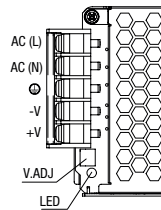

PS3V-100AF

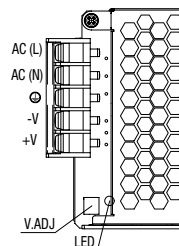

PS3V-100AF

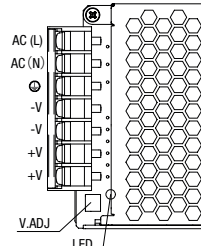

**Push-in terminal type**

PS3V-030AF

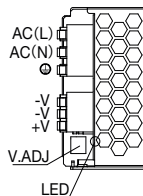

PS3V-050AF

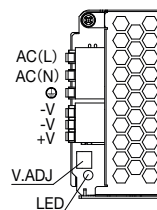

PS3V-100AF

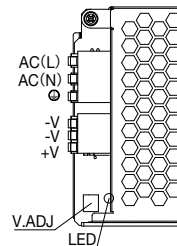

PS3V-100AF

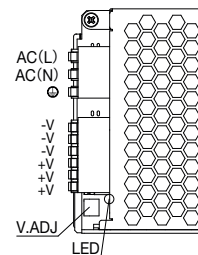

Note) 15W is not available for Push-in type.

Marking	Name	Description	Marking	Name	Description
AC(L), AC(N)	AC input terminal	Accepts a wide range of voltage and frequency.	V.ADJ	Output voltage adjustment volume	Allows adjustment within $\pm 10\%$ . Turning clockwise increases the output voltage.
⊕	Ground terminal	Be sure to connect the terminal to a proper ground.	LED	Operation indicator	Lights on when the output voltage is on.
+V, -V	DC output terminals	Output terminal			

**Dimensions**

All dimensions in mm.  
General tolerance:  $\pm 1$  mm

**Horizontal terminal type**

PS3V-015AF □ C

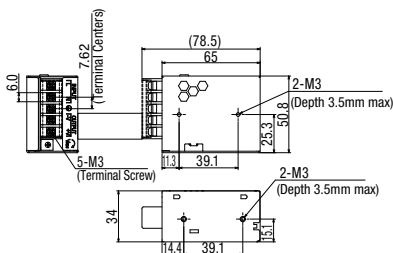

PS3V-030AF □ C

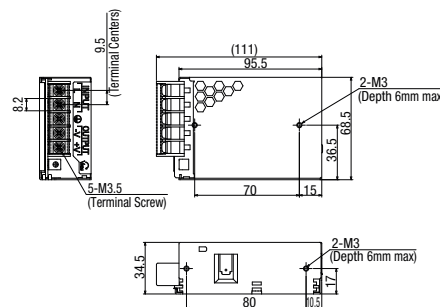

PS3V Switching Power Supplies

Dimensions

All dimensions in mm.  
General tolerance:  $\pm 1$  mm

PS3V-050AF□C

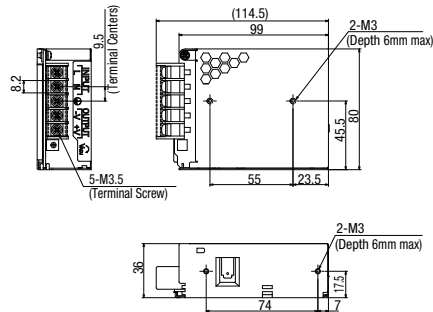

PS3V-100AF24C

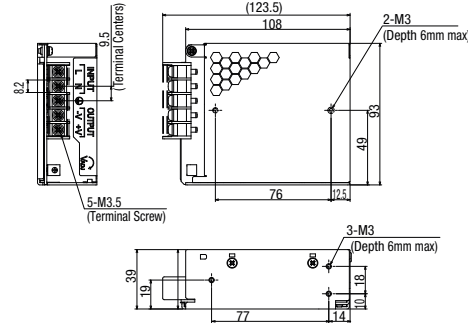

PS3V-150AF24C

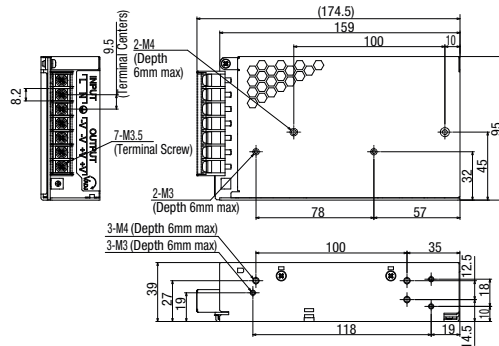

Push-in terminal type

PS3V-030AF□P

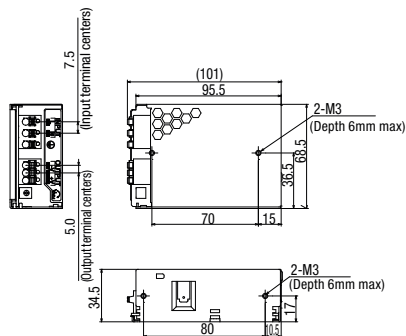

PS3V-050AF□P

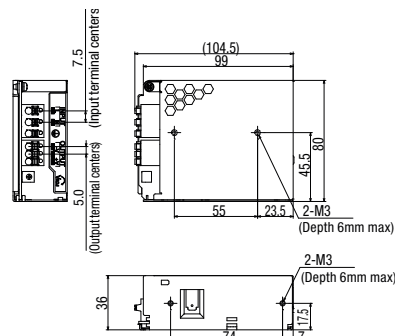

PS3V-100AF24P

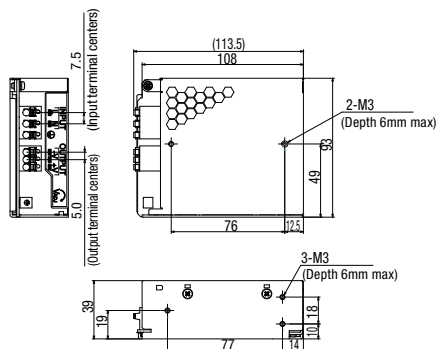

PS3V-150AF24P

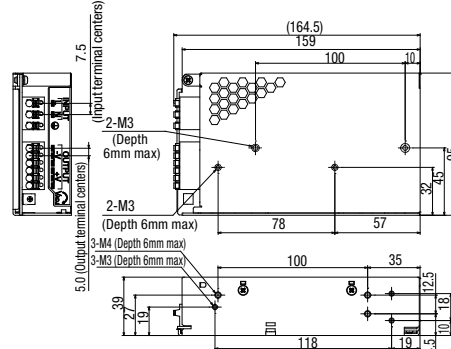



**Mounting bracket (L-shaped bracket) Dimensions**

All dimensions in mm.

PS9Z-3N3A (applicable model: 15W)

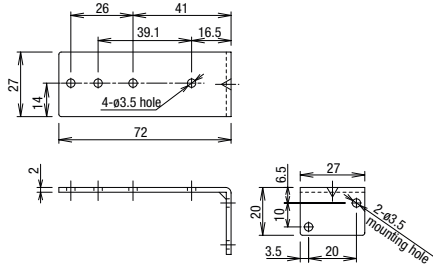

PS9Z-3E3B (applicable model: 30W/50W/100W)

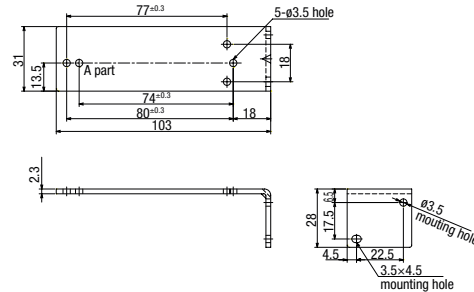

**Dimensions when mounting bracket is used**

All dimensions in mm.

**L-mount bracket**

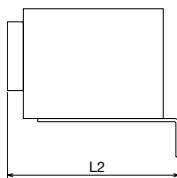

Part no.	Applicable model	L2
PS9Z-3N3A	PS3V-015AF□C	83.5
	PS3V-030AF□C	118.5
	PS3V-030AF□P	108.5
PS9Z-3E3B	PS3V-050AF□C	125.5
	PS3V-050AF□P	115.5
	PS3V-100AF□C	130.5
	PS3V-100AF□P	120.5

**DIN-rail mount bracket**

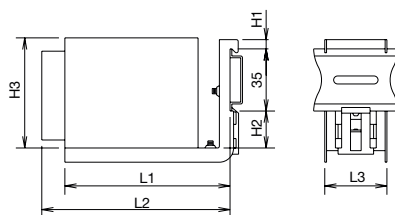

Part no.	Applicable model	L1	L2	L3	H1	H2	H3
PS9Z-3N4B	PS3V-015AF□C	93	107	35	5.2	21	50.8
	PS3V-030AF□C	134	136	35	5.2	21	68.5
PS9Z-3E4C	PS3V-030AF□P	134	125	35	5.2	21	68.5
	PS3V-050AF□C	134	134	35	5.2	21	80
	PS3V-050AF□P	134	124	35	5.2	21	80
	PS3V-100AF□C	186	186	39.5	5.2	20	93
PS9Z-3E4D	PS3V-100AF□P	186	176	39.5	5.2	20	93
	PS3V-150AF□C	186	192	39.5	5.2	20	95
	PS3V-150AF□P	186	182	39.5	5.2	20	95

**⚠ Safety Precautions**

This product is for use in control panels and inside products and cannot be externally connected.  
Do not use the product alone as an Electric Facilities for General Use.

- When using the product, follow the following precautions.

**[Precautions on switching power supplies]**

- This product is for industrial or general electronic equipment (such as communication, measurement, and industrial electronic equipment). Do not use for devices that may cause malfunction or may harm the body or threaten human life.
- Make sure that the input voltage and output current do not exceed the ratings. Otherwise, electric shock, fire, or malfunction may occur.
- Do not touch the terminals of the switching power supply while input voltage is applied, otherwise electric shock may occur.
- Take protective measures with the final product to prevent malfunctions caused by the switching power supply.

- Operating temperatures should not exceed the ratings. Be sure to note the derating characteristics. Otherwise, electric shock, fire, or malfunction may occur.
- Blown fuses indicate that the internal circuits are damaged. Contact IDEC for repair. If only the fuse is replaced, electric shock, fire, or malfunction may occur.
- Do not use the switching power supplies to charge rechargeable batteries.
- Do not overload or short-circuit the switching power supply for a long period of time, otherwise the internal elements may be damaged.
- Do not disassemble, repair, or modify the power supplies, otherwise the high voltage internal part may cause electric shock, fire, or malfunction.

## PS3V Switching Power Supplies

### Instructions

For details on mounting, wiring, and circuit examples, see the instruction manual from the below URL.  
URL: <https://product.idec.com/?product=PS3V>



### Notes for installation

- When mounting the PS3V, see page 7.
- See page 7 and 8 for mounting hole layout.
- Use M3 or M4 screw as mounting screws. The tightening torque of the mounting screw is 0.49N·m.

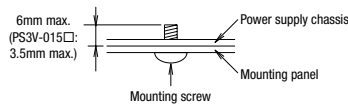

- Do not close the openings of the switching power supply. Ensure proper heat dissipation by convection.
- Maintain a minimum of 20 mm clearance around the switching power supply.
- When derating of the output does not work, provide forced air-cooling.
- Make sure to wire the ground terminal correctly.
- Use copper wire only. In addition, refer to the below table to select wire types and number of wires.

Terminal	Wire size (Allowable current)	Wire type
Input	AWG18 to 14	Copper, solid/stranded
Output	AWG18 to 14 (AWG18-7A, AWG16-10A, AWG14-15A)	

- Cross section - AWG18: 0.82mm<sup>2</sup>, AWG16: 1.31mm<sup>2</sup>, AWG14: 2.08mm<sup>2</sup>
- See page 11 for Push-in type

- Recommended tightening torque of terminal screws: 0.8 N·m (PS3V-015□: 0.5N·m)

### Adjustment of output voltage

The output voltage can be adjusted within  $\pm 10\%$  of the rated output voltage by using the V.ADJ control. Turning the V.ADJ clockwise increases the output voltage. Turning counterclockwise decreases the output voltage. Note that overvoltage protection may function when output voltage is increased.

### Overcurrent protection

The output voltage drops automatically when an overcurrent flows, resulting in intermittent operation. Normal voltage is automatically restored when the load returns to normal condition. However, overcurrent for a prolonged period of time or short-circuit causes the internal elements to deteriorate or break down.

### Overvoltage protection

- PS3V-015□:  
Voltage limit and auto-recovery method. The switching power supplies operate normally when voltage returns to normal.
- PS3X-030□, -050□, -100□, -150□:

The output is turned off or intermittent operation when an overvoltage is applied. When the output voltage has dropped due to an overvoltage, turn the input off, and after one minute, turn the input on again.

### Insulation/Dielectric test

When performing an insulation/dielectric test, short the input (between AC) and output (between + and -). Do not apply or interrupt the voltage suddenly, otherwise surge voltage may be generated and the power supply may be damaged.

### Noise

Small acoustic noise inside the PS3V may be heard depending on the input voltage and load, but the performance of the PS3V is not affected.

### Series operation

The following series operation is allowed. In (b) series operation, connect Schottky barrier diodes. Choose (a) series operation when using the PS3V as positive and negative output power supply. Insert a Schottky barrier diode for loads such as operational amplifier where outputs of two power supplies may be connected in series (Load 3). Select a Schottky diode in consideration of the rated current.

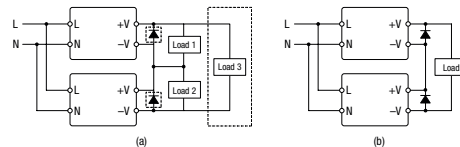

### Parallel operation

Parallel operation is not possible to increase the output capacity, because the internal elements and load may be damaged. Backup operation is a connection method of two switching power supplies in parallel for emergency. Normally one switching power supply has a sufficient output. If one switching power supply fails, another one operates to continue the output. Make sure that the sum of power consumption by load and diode is not greater than the rated wattage (rated voltage  $\times$  rated current) of one switching power supply. The current of the diode that is used must be more than double the output current of PS3V. Take heat dissipation into consideration.

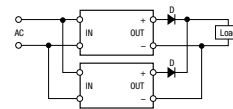

### Rust and scratches on metal parts

Hot-dip galvanized steel and bonderized steel are used for the PS3V. Rust on the edge and scratches on the surfaces may be developed depending on the storage condition, but the performance of the PS3V is not affected.

Accessories and wiring for Push-in terminals

**Wire size and recommended ferrules** (Push-in terminal type only)

Ferrules with insulated covers

	Applicable Wire (Stranded Wire)		Wire Strip Length (mm)	Part No. (Ordering No.)
	AWG	mm <sup>2</sup>		
For 1 wire	18	0.75	12	S3TL-H075-16WW
	17	1.0	12	S3TL-H10-16WY
	16	1.5	12	S3TL-H15-16WR
For 2 wires	18	0.75	21	S3TL-J075-19WWS

Recommended tools (Optional. See page 4 for details)

Name	Part No. (Ordering No.)
Crimping tool	S3TL-CR06D
Auto-adjust stripping tool	S3TL-ST06
Insulated screwdriver	S3TL-D04-25-75

Note) Use a flat blade screwdriver with a blade size of 0.4×2 to 2.5 mm.

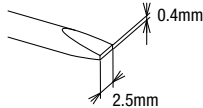

**Wiring procedure**

**Wiring**

(1) Insert the solid wire or stranded wire with ferrule into the terminal entrance.

\* If the shape of the ferrule becomes trapezoidal after the clamping, insert the ferrule with the long side of the clamped part parallel to the pusher.

\* When inserting stranded wires directly, make sure that the pusher is pressed down and there are no loose wires.

Note) When inserting a ferrule terminal with two wires, insert the insulated cover part vertically to the pusher.



Pusher



Insulated cover part

(2) After wiring, tug lightly to make sure that the wire is properly connected.

**Removing the wire**

(1) Press the pusher using an insulated screwdriver.



(2) Remove the wire by pressing the pusher.



Warranty

**Warranty**

IDEC warrants the PS3V switching power supplies for a period of five years from the date of shipment.

**Scope**

In the event of a failure caused by our responsibility within the above period, we will replace the product. However, if the product is used under the following conditions, the warranty may not apply even within the warranty period.

1. Average operating temperature (ambient temperature of switching power supply) is 40°C maximum.
2. The load is 60% maximum.
3. Input voltage is the rated input voltage.
4. Standard mounting style

If we are responsible for a failure that occurs during the warranty period described at left, we will repair the product or replace it with an alternative product.

Please note that we will not be liable for any damage caused by the failure of the delivered product. In addition, please note that the warranty does not apply to the following cases.

1. Inappropriate handling, or operation beyond the specifications.
2. Modification or repair by other than IDEC.
3. Failure caused by reasons other than the switching power supply.
4. Failure caused by natural disasters.

## Ordering Terms and Conditions

Thank you for using IDEC Products.

By purchasing products listed in our catalogs, datasheets, and the like (hereinafter referred to as "Catalogs") you agree to be bound by these terms and conditions. Please read and agree to the terms and conditions before placing your order.

### 1. Notes on contents of Catalogs

- (1) Rated values, performance values, and specification values of IDEC products listed in this Catalog are values acquired under respective conditions in independent testing, and do not guarantee values gained in combined conditions.  
Also, durability varies depending on the usage environment and usage conditions.
- (2) Reference data and reference values listed in Catalogs are for reference purposes only, and do not guarantee that the product will always operate appropriately in that range.
- (3) The specifications / appearance and accessories of IDEC products listed in Catalogs are subject to change or termination of sales without notice, for improvement or other reasons.
- (4) The content of Catalogs is subject to change without notice.

### 2. Note on applications

- (1) If using IDEC products in combination with other products, confirm the applicable laws / regulations and standards.  
Also, confirm that IDEC products are compatible with your systems, machines, devices, and the like by using under the actual conditions. IDEC shall bear no liability whatsoever regarding the compatibility with IDEC products.
- (2) The usage examples and application examples listed in Catalogs are for reference purposes only. Therefore, when introducing a product, confirm the performance and safety of the instruments, devices, and the like before use. Furthermore, regarding these examples, IDEC does not grant license to use IDEC products to you, and IDEC offers no warranties regarding the ownership of intellectual property rights or non-infringement upon the intellectual property rights of third parties.
- (3) When using IDEC products, be cautious when implementing the following.
  - i. Use of IDEC products with sufficient allowance for rating and performance
  - ii. Safety design, including redundant design and malfunction prevention design that prevents other danger and damage even in the event that an IDEC product fails
  - iii. Wiring and installation that ensures the IDEC product used in your system, machine, device, or the like can perform and function according to its specifications
- (4) Continuing to use an IDEC product even after the performance has deteriorated can result in abnormal heat, smoke, fires, and the like due to insulation deterioration or the like. Perform periodic maintenance for IDEC products and the systems, machines, devices, and the like in which they are used.
- (5) IDEC products are developed and manufactured as general-purpose products for general industrial products. They are not intended for use in the following applications, and in the event that you use an IDEC product for these applications, unless otherwise agreed upon between you and IDEC, IDEC shall provide no guarantees whatsoever regarding IDEC products.
  - i. Use in applications that require a high degree of safety, including nuclear power control equipment, transportation equipment (railroads / airplanes / ships / vehicles / vehicle instruments, etc.), equipment for use in outer space, elevating equipment, medical instruments, safety devices, or any other equipment, instruments, or the like that could endanger life or human health
  - ii. Use in applications that require a high degree of reliability, such as provision systems for gas / waterworks / electricity, etc., systems that operate continuously for 24 hours, and settlement systems
  - iii. Use in applications where the product may be handled or used deviating from the specifications or conditions / environment listed in the Catalogs, such as equipment used outdoors or applications in environments subject to chemical pollution or electromagnetic interference  
If you would like to use IDEC products in the above applications, be sure to consult with an IDEC sales representative.

### 3. Inspections

We ask that you implement inspections for IDEC products you purchase without delay, as well as thoroughly keep in mind management/maintenance regarding handling of the product before and during the inspection.

### 4. Warranty

- (1) Warranty period  
The warranty period for IDEC products shall be five (5) years after purchase or delivery to the specified location. However, this shall not apply in cases where there is a different specification in the Catalogs or there is another agreement in place between you and IDEC.
- (2) Warranty scope  
Should a failure occur in an IDEC product during the above warranty period for reasons attributable to IDEC, then IDEC shall replace or repair that product, free of charge, at the purchase location / delivery location of the product, or an IDEC service base. However, failures caused by the following reasons shall be deemed outside the scope of this warranty.
  - i. The product was handled or used deviating from the conditions / environment listed in the Catalogs
  - ii. The failure was caused by reasons other than an IDEC product
  - iii. Modification or repair was performed by a party other than IDEC
  - iv. The failure was caused by a software program of a party other than IDEC
  - v. The product was used outside of its original purpose
  - vi. Replacement of maintenance parts, installation of accessories, or the like was not performed properly in accordance with the user's manual and Catalogs
  - vii. The failure could not have been predicted with the scientific and technical standards at the time when the product was shipped from IDEC
  - viii. The failure was due to other causes not attributable to IDEC (including cases of force majeure such as natural disasters and other disasters)
 Furthermore, the warranty described here refers to a warranty on the IDEC product as a unit, and damages induced by the failure of an IDEC product are excluded from this warranty.

### 5. Limitation of liability

The warranty listed in this Agreement is the full and complete warranty for IDEC products, and IDEC shall bear no liability whatsoever regarding special damages, indirect damages, incidental damages, or passive damages that occurred due to an IDEC product.

### 6. Service scope

The prices of IDEC products do not include the cost of services, such as dispatching technicians. Therefore, separate fees are required in the following cases.

- (1) Instructions for installation / adjustment and accompaniment at test operation (including creating application software and testing operation, etc.)
- (2) Maintenance inspections, adjustments, and repairs
- (3) Technical instructions and technical training
- (4) Product tests or inspections specified by you

The above content assumes transactions and usage within your region. Please consult with an IDEC sales representative regarding transactions and usage outside of your region. Also, IDEC provides no guarantees whatsoever regarding IDEC products sold outside your region.

# IDEC CORPORATION

#### Head Office

6-64, Nishi-Miyahara-2-Chome, Yodogawa-ku, Osaka 532-0004, Japan

<b>USA</b>	IDEC Corporation	Tel: +1-408-747-0550	opencontact@idec.com	<b>Hong Kong</b>	IDEC Izumi (H.K.) Co., Ltd.	Tel: +852-2803-8989	info@hk.idec.com
<b>Germany</b>	APEM GmbH	Tel: +49-40-25 30 54-0	service@eu.idec.com	<b>China</b>	IDEC (Shanghai) Corporation	Tel: +86-21-6135-1515	idec@cn.idec.com
<b>Singapore</b>	IDEC Izumi Asia Pte. Ltd.	Tel: +65-6746-1155	info@sg.idec.com		Beijing Branch	Tel: +86-10-6581-6131	idec@cn.idec.com
<b>Thailand</b>	IDEC Asia (Thailand) Co., Ltd	Tel: +66-2-392-9765	sales@th.idec.com		Guangzhou Branch	Tel: +86-20-8362-2394	idec@cn.idec.com
<b>India</b>	IDEC Controls India Private Limited	Tel: +91-80679-35328	info_india@idec.com	<b>Japan</b>	IDEC Corporation	Tel: +81-6-6398-2527	jp_marketing@idec.com
<b>Taiwan</b>	IDEC Taiwan Corporation	Tel: +886-2-2577-6938	service@tw.idec.com				

 www.idec.com

Specifications and other descriptions in this brochure are subject to change without notice.  
Information in this brochure is current as of May, 2021.  
2021 IDEC Corporation, All Rights Reserved.  
EP1742-1

