



LED Lighting
LF3D/LF1D



LUMIFA™

Excellent optical performance and robust construction
suitable for use in machine tools



LUMIFA

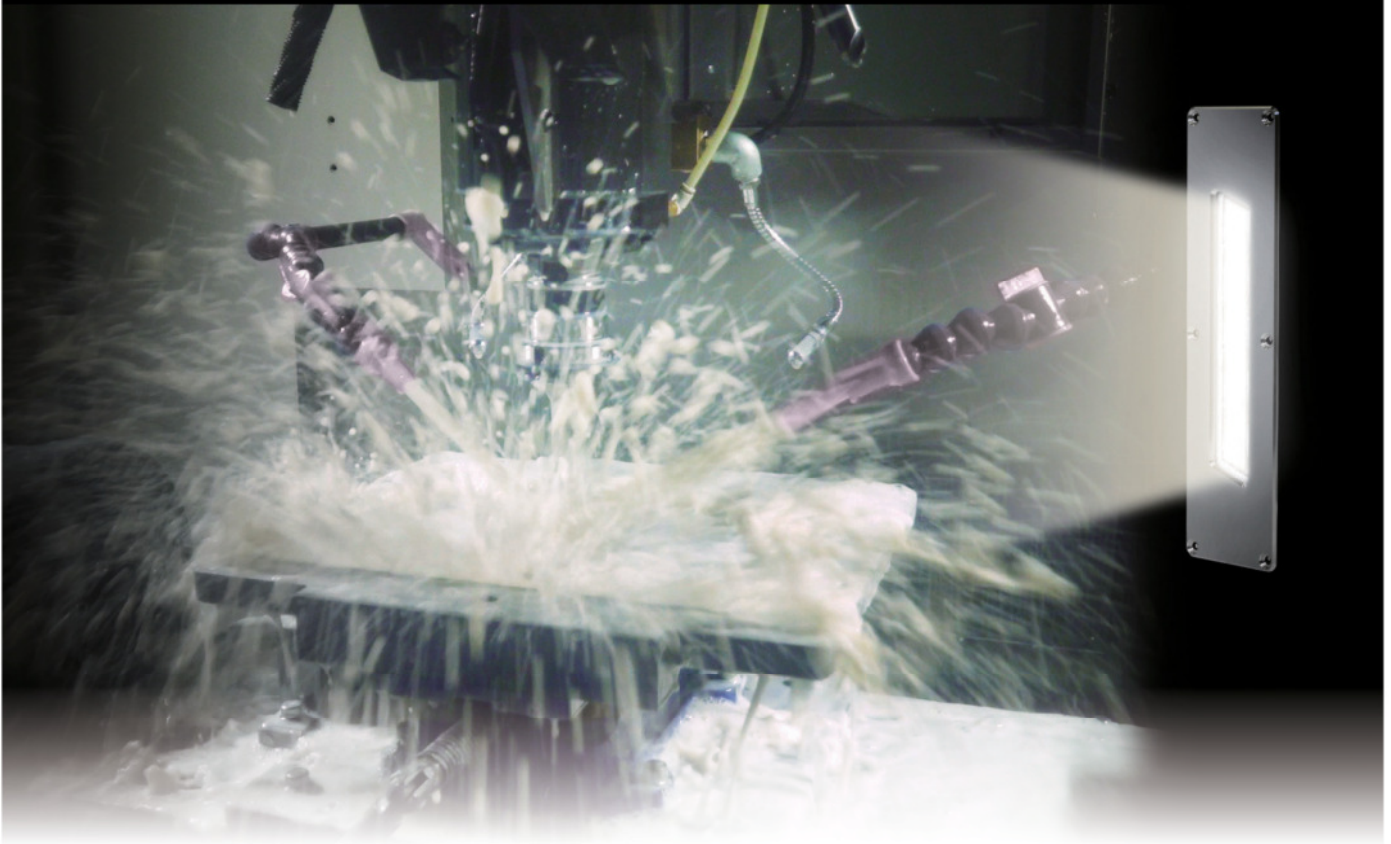

Effective solution for machine tools

LED lighting inside machine tool allows for clear identification of chatter marks

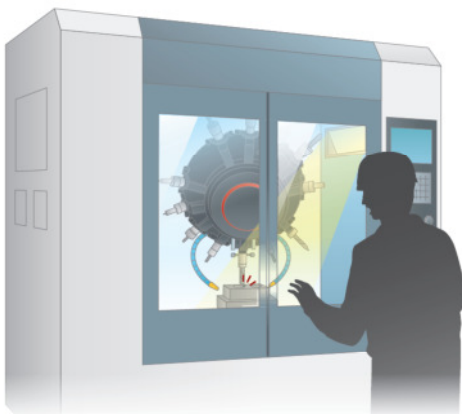

BEFORE

- Hard to see chatter marks

Glare from LED lighting inside the machine tool could be mistaken as chatter marks while visually checking the machine operation. This often caused chatter marks to be left untreated, delaying maintenance and worsening the situation.



AFTER

- LED lighting improves machining efficiency

IDEC's unique optical technology enables the light to shine evenly on the surface, suppressing multiple shadows and allowing the operator to see scratches and unevenness on the workpiece. LF3D lighting makes it possible to check whether chatter marks have been generated or not easily, at a glance.

Provides high-quality and uniform lighting
on the surface of target objects
and inside the work area



Eliminates the multi-shadow effect

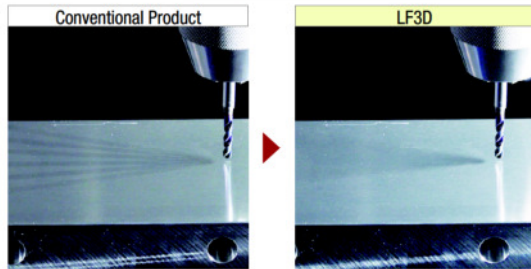

▶ Reduced multi-shadow effect enables easy visual inspection of the machined surface. [Patent pending (LF3D)]

Reduces reflection from light source

LED light source reflects on the workpiece and stripes appear.

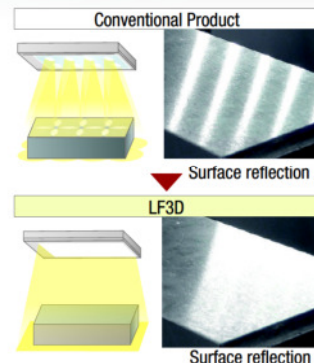

The LF3D LED allows the light to be evenly distributed to provide natural lighting, and enables visual inspection. [Patent pending (LF3D)]

Uniform lighting provides uniform illumination inside the work area

By combining our optical design technology gained by development of LED lighting & sensors and by optimum LED alignment, the brightness contrast difference is improved by 85%.

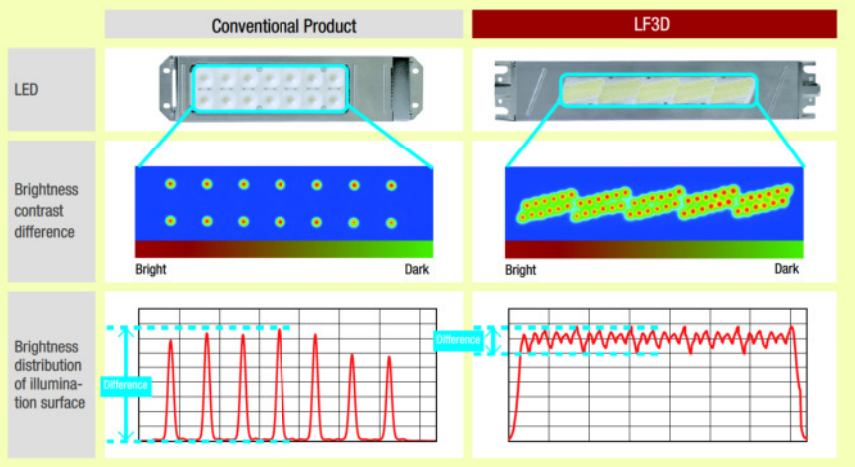

Select from standard or diffused light distribution depending on the machine tool needs

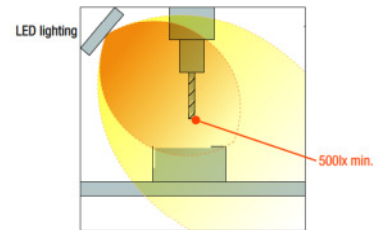
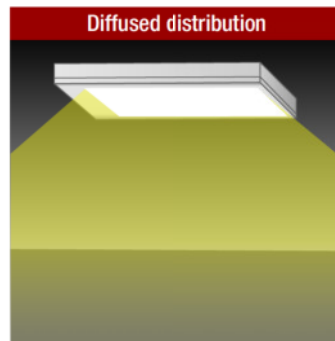
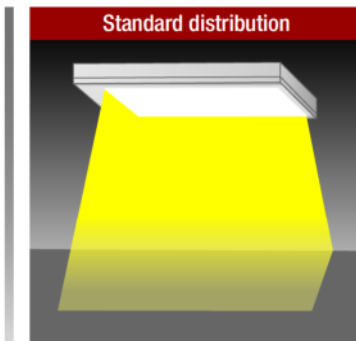

*At least 500 lx shall be provided when arranging lighting for machines.
(EN1837:1999+A1:2009 4.2)

Equipped with glare mode to prevent operators from glare during maintenance

[Patent pending (LF3D)]

Modes can be changed by just the wiring. Complicated settings such as PWM and dedicated controllers are not required.

▶ Application example: Functions with opening & closing of doors / switching with control panel

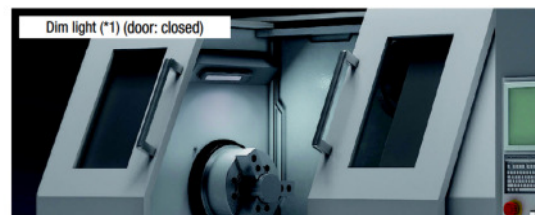
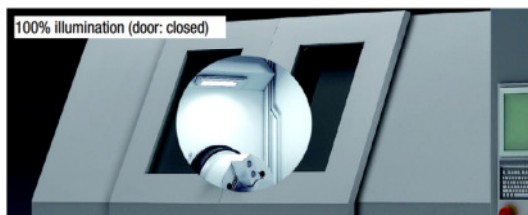

*1) Approx. 40% illumination

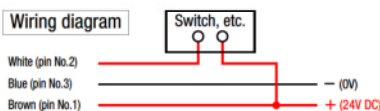

Rugged construction and environmentally resistant

Suitable for use in machine tools

**IP67G
IP69K**

▶ Degree of protection IP67G / IP69K

Oil-resistant gasket and unique structural design achieves IP67G protection degree. (*1)

Withstands exposure to water and oil. (*2)

IP69K for use in high-pressure, high-temperature washdown.

*1) IP67F (LF1D)

*2) Oil used for testing: Insoluble oil JIS N3-8

Robust

▶ Robust material

Reinforced glass, stainless steel, zinc diecast, extruded aluminum prevents damage from scraps

High temp.

▶ Resistant to high temperature

Wide operating temperature range (up to 55°C).

Improved design and user-friendly

Compact, slim, and light compared to conventional products

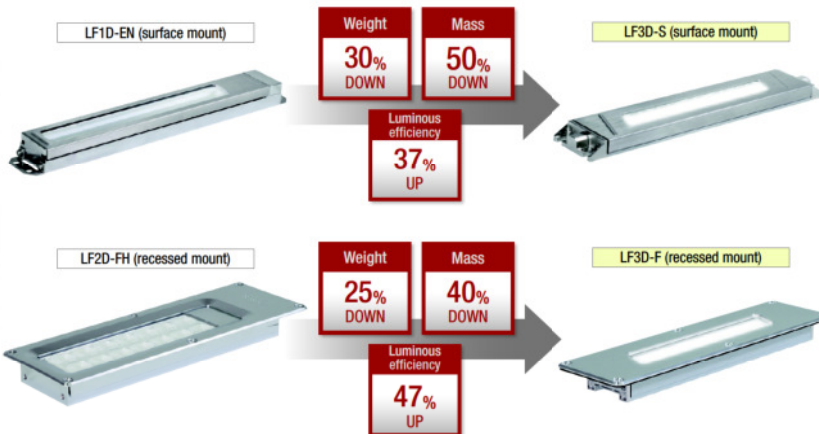

Easy replacement with conventional products

Panel cut-out for older LED lighting will fit the new LF3D LED.

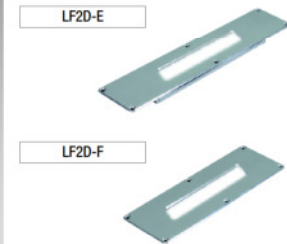

Accessories for surface mount type replacements available.

Wide variety of connector types available

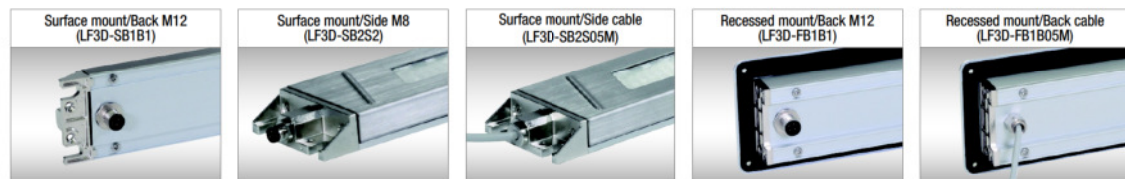

Wide selection of models to suit a various machine tools

	For small machines	For small to medium machines		For large machines
		NEW		
Application	Brightly lights machine tool tips and inside small machines	Standard lens provides brilliant light on the edges of tools and work pieces . Diffused lens provides wide light distribution inside work areas.		Wide illumination inside the work area or replacements for fluorescent lamps
Part no.	LF1D-C	LF3D-S	LF3D-F	LF1D-H/J
Shape	Surface mount	Surface mount	Recessed mount	Surface mount
Luminous Flux (typ.)	560 lm	1700 lm		2000 lm (LF1D-H) 3000 lm (LF1D-J)
Reference Illuminance (typ.) at 1.0m directly below	180 lx	1800 lx (standard distribution) 1000 lx (diffused distribution)		560 lx (LF1D-H) 840 lx (LF1D-J)
Dimensions (W x H x D)	50 x 25 x 100 mm	55.8 x 17.5 x 310 mm	80 x 27 x 307 mm	84 x 24.8 x 365 mm (LF1D-H) 84 x 24.8 x 510 mm (LF1D-J)

LF3D/LF1D LED Lighting



LF3D LED Lighting

LF3D

Package Quantity: 1

Model		LF3D			
Light distribution		Standard		Diffused	
Style		Surface mount (*1)	Recessed mount	Surface mount (*1)	Recessed mount
Illumination surface		Reinforced glass			
Connection direction	Cable / Connector	Part no. (Ordering no.)			
Side	5m cable	LF3D-SB2S05M	—	LF3D-SB1S05M	—
	M8 connector	LF3D-SB2S2	—	LF3D-SB1S2	—
Rear	5m cable	—	LF3D-FB2B05M	—	LF3D-FB1B05M
		—	LF3D-F1B2B05M (*2)	—	LF3D-F1B1B05M (*2)
		—	LF3D-F2B2B05M (*3)	—	LF3D-F2B1B05M (*3)
	M12 connector	—	LF3D-FB2B1	—	LF3D-FB1B1
		—	LF3D-F1B2B1 (*2)	LF3D-SB1B1	LF3D-FB1B1
		—	LF3D-F2B2B1 (*3)	—	—

*1) Contact IDEC for customers using LF1D-E (EH/EN) or LF1D-F (FH).

*2) Size and mounting centers compatible with LF2D-E (EH/EN), (LF3D-F1)

*3) Size and mounting centers compatible with LF2D-F (FH), (LF3D-F2)

Performance Specifications

Model	LF3D	
Style	Uniform light source / slim type	
Light distribution	Standard	Diffused
Rated voltage	24V DC	
Operating voltage range	21.6 to 26.4V DC	
Rated Power (typ.) (at rated voltage)	9.2W	
Illumination color	Cool white	
Color temp. (typ.)	5700K	
Luminous Flux (typ.)	1700 lm	
Reference Illuminance (typ.) at 1.0m directly below	1800 lx	1000 lx
Insulation resistance	100MΩ minimum (500V DC megger)	
Dielectric strength	1000V AC, 50/60Hz, 1 minute	
Vibration resistance (damage limits)	Frequency 5 to 55Hz, amplitude 0.5mm	
Shock resistance (damage limits)	1000m/s ²	
Operating temperature	-30 to +55°C (no freezing)	
Operating relative humidity	45 to 85%RH (no condensation)	
Storage temperature	-35 to +70°C (no freezing)	
Operating atmosphere	No corrosive gas	
Light source life (*1)	50,000 hours (The illumination duration in which the brightness maintains a minimum of 70%) (Ta = 25°C, 45%RH max.)	
Degree of protection (*2)	Surface mount: IP65, IP67, IP67G, IP69K Recessed mount: IP65, IP67, IP67G	
Glare save mode (GS-Mode) (*3)	White wire (pin no.1) - open: 100% light on White wire (pin no.1) and brown wire (pin no.2) - short-circuit: dim light	
Material (Main parts)	Main body: Aluminum Front cover (surface mount): Stainless steel Flange (recessed mount): Aluminum Side cover: Zinc die-cast (plating) Illumination part surface: Reinforced glass Gasket: NBR	
Weight (approx.)	LF3D-S: 680g (*4) LF3D-F: 770g (*4)	LF3D-F1: 830g (*4) LF3D-F2: 870g (*4)
Light Distribution Curve (reference value) (unit: cd/1000 lm)		

• Due to variations in LED elements, products may vary in illumination color and illuminance.

*1) Not a guaranteed value. The actual life may differ depending on the operating environment and conditions. Specifications are subject to change without notice.
Ta is the ambient temperature of this product.

*2) Testing conditions specified by IEC60529 (IP67), JIS C 0920 (IP67F/IP67G), and DIN40050-9 (IP69K)
Not guaranteed for every operating condition (the rated value of the protective structure is when the product is mounted.)

*3) Dimming differs according to the operating environment.
Not a fixed value. (Ta=25°C typ.)

*4) Weight of cable type.

Cross-sectional direction of light distribution



Internal Circuit

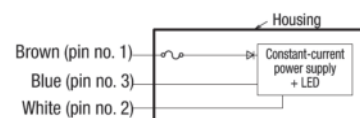

LF1D LED Lighting

LF1D

LF1D-H/LF1D-J Long type

Package Quantity:

Model		LF1D-H	LF1D-J
Mount style		Surface mount	
Illumination surface		Reinforced glass	
Cable direction	Cable length	Part no. (Ordering no.)	
Side	5m	LF1D-H2F-2N-350	LF1D-J2F-2N-350
	1.5m + M12 connector	LF1D-H2F-2N-3B0	LF1D-J2F-2N-3B0
Rear	5m	LF1D-H2F-2N-450	LF1D-J2F-2N-450
	1.5m + M12 connector	LF1D-H2F-2N-4B0	LF1D-J2F-2N-4B0

LF1D-C Mini model L=100mm

Package quantity: 1

Shape	Surface mount	
Illumination Surface	Reinforced glass	
Cable	Length	Part No.
Side	3m	LF1D-C2F-2W-330
	5m	LF1D-C2F-2W-350
Back	3m	LF1D-C2F-2W-430
	5m	LF1D-C2F-2W-450

Performance Specifications

Model	LF1D-H	LF1D-J	LF1D-C
Style	Long type L=365mm	Long type L=510mm	Mini
Light distribution	Diffused		
Rated voltage	24V DC		
Operating voltage range	21.6 to 26.4V DC		
Rated Power (typ.) (at rated voltage)	18.4W	27.6W	4.6W
Illumination color	Neutral white		White
Color temp. (typ.)	4700K		5,700K
Luminous Flux (typ.)	2000 lm	3000 lm	560 lm
Reference Illuminance (typ.) at 1.0m directly below	560 lx	840 lx	180 lx
Insulation resistance	100MΩ minimum (500V DC megger)		
Dielectric strength	1000V AC, 50/60Hz, 1 minute		
Vibration resistance (damage limits)	Frequency 5 to 55Hz, amplitude 0.5mm		
Shock resistance (damage limits)	1000m/s ²		
Operating temperature	-30 to +55°C (no freezing)		
Operating relative humidity	45 to 85%RH (no condensation)		
Storage temperature	-35 to +70°C (no freezing)		
Operating atmosphere	No corrosive gas		
Light source life (*1)	50,000 hours (The illumination duration in which the brightness maintains a minimum of 70%) (Ta=25°C, 45%RH max.)		
Degree of protection (*2)	IP67, IP67F, IP69K		
Material (Main parts)	Main body: Front cover (surface mount): Illumination part surface: Gasket:	Aluminum Stainless steel Reinforced glass NBR	Housing: aluminum Front cover: stainless steel Lens: reinforced glass
Weight (approx.)	LF1D-H2F-2N-350: 1200g	LF1D-J2F-2N-350: 1600g	LF1D-C2F-2W-350: 420g
Light Distribution Curve (reference value) (unit: cd/1000 lm)			

• Due to variations in LED elements, products may vary in illumination color and illuminance.

*1) Not a guaranteed value. The actual life may differ depending on the operating environment and conditions. Specifications are subject to change without notice. Ta is the ambient temperature of this product.

*2) Testing conditions specified by IEC60529 (IP67), JIS C 0920 (IP67F/IP67G), and DIN40050-9 (IP69K)

Not guaranteed for every operating condition (the rated value of the protective structure is when the product is mounted.)

Cross-sectional direction of light distribution

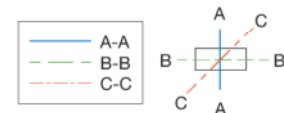

Internal Circuit

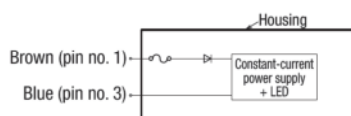

LF3D/LF1D LED Lighting

Dimensions (LF3D)

Dimensions in mm

LF3D (surface mount)

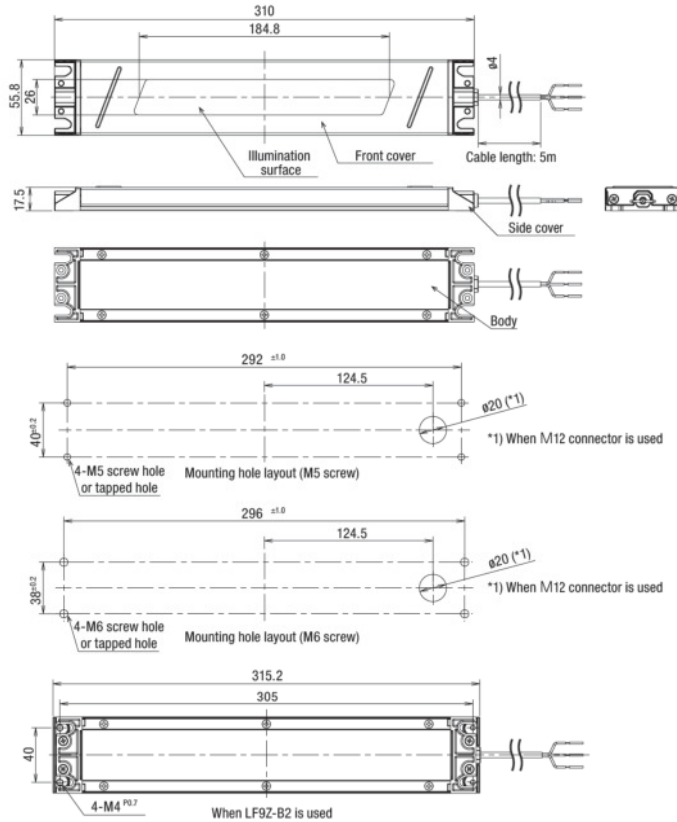

5m cable



M8 connector



M12 connector

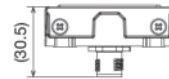

Connector Wiring

M8 connector

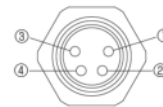

M12 connector

(A coding)



Use a connector on a power supply side that satisfies the required degree of protection.

Recommended connector: Harting (M8 connector)

Phoenix Contact (M12 connector)

Pin No.	Wiring color	Function	Connection
①	Brown	+DC	Power Supply +24V
②	White	GS Mode	Open or +DC
③	Blue	-DC	Power Supply 0V(GND)
④	-	N.C.	

LF3D (recessed mount)

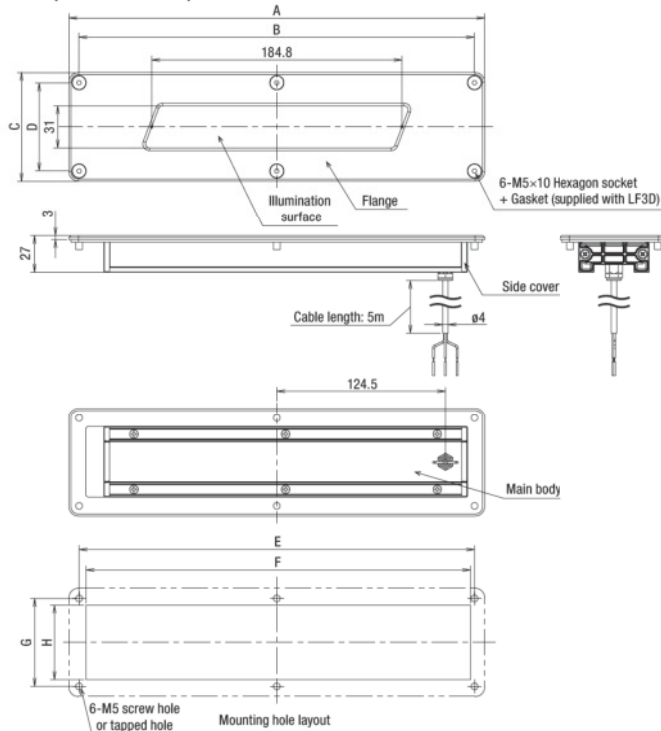

5m cable type

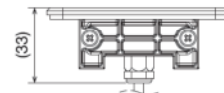

M12 connector type

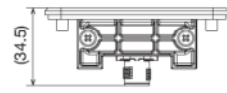

Model	Dimensions (mm)		
	LF3D-F	LF3D-F1	LF3D-F2
A	307	389	308
B	292	374	293
C	80	80	105
D	65	65	90
E	292	374	293
F	284	366	286
G	65	65	90
H	55	55	80

Connector Wiring

M12 connector type (A coding)



Use a connector on a power supply side that satisfies the required degree of protection. Phoenix Contact (M12 connector)

Pin no.	Wiring color	Function	Connection
①	Brown	+DC	Power Supply +24V
②	White	GS Mode	Open or +DC
③	Blue	-DC	Power Supply 0V(GND)
④	-	N.C.	

LF3D/LF1D LED Lighting

Dimensions (LF1D)

Dimensions in mm

Note: For mounting hole layout and the size of mounting screws on the back of the LED unit, see the specification sheet and dimensions supplied with the product.

LF1D-H [long type] L=365mm / LF1D-J [long type] L=510mm

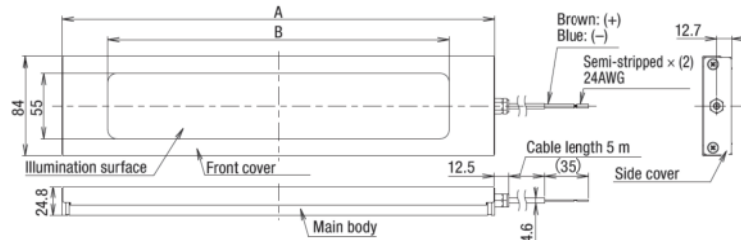

Dimensions (mm)		
Model	LF1D-H	LF1D-J
A	365	510
B	288	432

Connector Wiring

LF1D-H/J2F-2*-B* (M12 connector)



M12 connector: SAC-4P-MS SCO/150/1.5

Plug 4-pin assignment



Use a connector on the power supply side that satisfies the degree of protection.

Recommended connector:
Phoenix Contact
SAC-4P-1.5-PUR/FS SCO

LF1D-C (mini model)

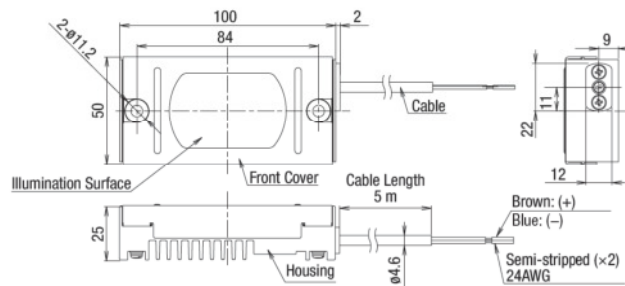

Accessories (LF3D)

Accessories exclusive for LF3D

Item	Shape	Type	Part no. (Ordering no.)	Package quantity	Remarks
Mounting Bracket		Example(LF9Z-B21)			
		Side connection	LF9Z-B21	2 (for right and left, supplied with mounting screws)	Bracket used for mounting LF1D-E (EN/EH) from the back with the same mounting centers.
	Back connection	LF9Z-B22	2 (for right and left, supplied with mounting screws)		
M12 connector cable		Straight	LF9Z-CM13	1	Length: 3m
		Right angle	LF9Z-CM23	1	

• Accessories are not supplied with the product.

LF3D/LF1D LED Lighting

Safety Precautions

- Do not disassemble, repair, or modify the product. Otherwise electric shock, fire, or malfunction may occur.
- Turn off power before wiring. Make sure that the temperature has lowered sufficiently before wiring.
- To prevent electric shock or damage, ensure that the wiring is correct.
- Do not stare directly into the LED while it is lit, and do not project the light towards other people, otherwise eyes may be injured.
- The product is a general-purpose industrial electric device.
- Ensure correct operating temperature. Operating temperature is the ambient temperature where the product will be used. Temperature exceeding the specified value may cause rise in internal temperature and cause damage to the unit.
- When using this product as part of or in connection with electrical equipment for general use (*), use a DC power supply unit with a PSE mark that conforms to the technical standards of the Product Safety Electrical Appliance & Material (PSE). For installation, follow the laws and regulations such as technical standards for electrical equipment and construction equipment standards.
*) Electrical facilities mainly for general residences and stores, receiving AC 600V or less, and small power generation facilities.
- The product is for indoor use only. Do not use outdoors, otherwise insulation failure, electric shock, or failure may result.
- Do not use for applications which may cause harm or injury in case a malfunction or failure occurs.

Instructions

- Due to variations in LED elements, products may vary in illumination color and illuminance.
- Before designing equipment and powering up the product, confirm the specifications described in the instruction sheet.
- Apply voltage within the rated value, otherwise the LED elements may be damaged.
- Do not use or store in a location subject to vibration and shock, otherwise electric shock or failure will result.
- Do not loosen screws, otherwise the protection characteristics will be impaired.
- To clean the cover, use a soft cloth with water or neutral detergent. Do not use solvents such as thinners, benzene, or alkaline, otherwise, discoloration, deterioration, or decrease in strength may occur.
- When using this product in environments subject to dust and water, make sure that the wiring part of cable or wire are dustproof/waterproof. Otherwise leakage, electric shock, or failure may occur.
- Do not use in the following locations:
 - ① Locations subject to high water pressure (environments exceeding protection degree IPX5, IPX7X or IPX9K in accordance with IEC 60529.)
 - ② Locations subject to dust (environments exceeding protection degree IP6X in accordance with IEC 60529.)
 - ③ Environment subject to corrosive gases, volatile gases, flammable gases, or chemicals that could affect the safety and reliability of the product.
 - ④ Locations subject to electric or magnetic fields.
 - ⑤ Subject to flammable substances.
 - ⑥ Exposed to direct sunlight, near heaters, high temperatures.
 - ⑦ Exposed to salt water.
 - ⑧ Subject to condensation or freezing, such as cold storage warehouse or air cooler outlet (make sure that condensation or freezing do not occur).
 - ⑨ Exposed to ozone, radiation, UV or other locations where safety and reliability of the product.
- When using the product as a UL/c-UL listed product, use a Class 2 power supply.
- Some metal parts are surface treated and the appearance may vary depending on each part. Also, some scratches may appear on the surface but does not affect product performance.

Warranty

- The warranty period is one year after delivery to the specified location.
*Exceptions to warranty coverage
The warranty period is reduced to six (6) months if the product is run continuously over 20 hours.
- In the event of a failure caused by our responsibility within the above period, we will replace the product free of charge at the place where the product was purchased or delivered.
*Does not include expenses required for mounting, replacing, or installation work.
- The warranty does not apply if the product is used outside of the conditions described in the instruction manual and specifications.

- LED lighting have a product life.
- Because internal elements deteriorate after 8 to 10 years of installation even if they have no defects in appearance, inspection and/or replacement are recommended. Operation condition: temperature 30°C, 3,000-hour operation per year (10 hours per day). (JIS C 8105-1)
- Product life is shortened under high operating temperature or when it is lit for long hours.
- Inspection and/or cleaning by user every 6 months is recommended.
- Inspection by contractors is recommended every 3 years.
- Do not use the product for a long time without inspection, otherwise smoke, fire, or electric shock may occur.

For details on mounting, wiring, and circuit examples, see the instruction manual from the below URL.

URL LF3D-S/F <https://product.idec.com/?product=LF3D>
 LF3D-F1 <https://product.idec.com/?product=LF3D-F1>
 LF3D-F2 <https://product.idec.com/?product=LF3D-F2>



LF3D-S/F



LF3D-F1



LF3D-F2

Machine tools industry solutions

Find out how IDEC has solved customers' problems in the machine tools industry.

Related products

A wide variety of safety switches covers small to large-size machine tools



Interlock switches with solenoid

HS5L HS1T



HS5L: 4-contact switches suitable for small doors. 2-contact switches suitable for food machinery and injection molding machines.

HS1T: 5000N locking strength is suitable for large machines and equipment, ensuring operator safety.

Compact safety pressure sensitive switch conforming to ISO13856-2



Safety edge switches

E30BK1

Available August, 2021



Conforms to ISO 13856-2 (pressure-sensitive protective devices). Ensures safety without reducing the opening/closing speed of automatic doors. The rubber part is made of oil-resistant NBR material, suitable for environments where oil mist is dispersed.

Diagnose and monitor safety systems



Safety relay modules

HR6S



Safety relay module to monitor and diagnose safety systems. Improves productivity by predictive maintenance of safety systems.

Reduce the cost of relay replacement

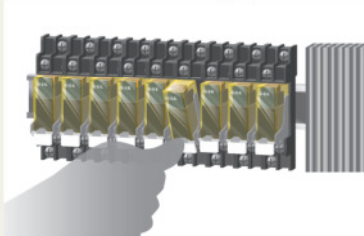

Slim power relays

RJ



Durable and compact slim power relays with high contact allowable current.

Prevent momentary stops that cause machine failures

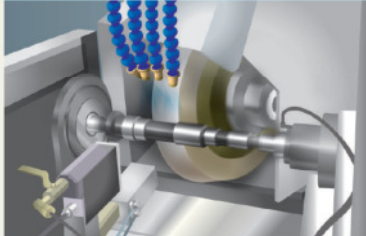

Switching power supplies

PS5R-V



High performance DIN rail power supplies with low profile, space saving 6-direction mounting, and spring-up terminals for wiring efficiency and safety. Mounting brackets are also available for direct mounting. Compliant with SEMI-F47 standards. (Certified for 208V AC input voltage.)

Smart RFID reader to manage user authority/log control



Smart RFID reader

KW2D



The compact RFID reader mounts on ø22 panel cut-out. Water- and oil-proof with verification functions. Suitable for controlling and tracking access to production sites.



30 COMPANIES



75 YEARS OF EXPERIENCE



3,900 EMPLOYEES WORLDWIDE



100 000 + REFERENCES

EMEA SALES & CUSTOMER SUPPORT

Contact our safety specialists at eu.support@idec.com

BENELUX

Belgicastraat 7/1
1930 ZAVENTEM
Belgium
BEL: (+32) 27 25 05 00
NL: (+31) (70) 799 91 51
be.sales@apem.com

FRANCE

55, avenue Edouard Herriot
BP1
82303 CAUSSADE Cedex
(+33) 5 63 93 14 98
fr.commercial@apem.com

GERMANY

Gewerbehof Giesing
Paulsdorferstr. 34, 2. OG
D-81549 MUNICH
MUNICH: (+49) 89 45 99 11 0
HAMBURG: (+49) 40 253054 0
info@apem.de

ITALY

Via Marconi 147G
12030 MARENE (CN)
(+39) 0172 74 3170
apem.italia@apem.com

SWEDEN

Torshamnsgatan 39
S-16440 KISTA
(+46) 8 626 38 00
info@apem.se

UNITED KINGDOM

Drakes Drive
LONG CRENDON,
Bucks HP18 9BA
England
(+44) 1 844 202400
sales@apem.co.uk

idec-emea.com

To receive our latest news, subscribe to our bimonthly newsletter: <https://bit.ly/3x06NgE>

 Follow us on LinkedIn

 Follow us on Youtube

