



Think Automation and beyond...

**LED Illumination Units
LF1D/LF2D**

LUMIFA™



Optimal lighting solution for machine tools

- **Uniform light distribution**
- **Robust, resistant, easy maintenance**

IDEC CORPORATION

Uniform light distribution

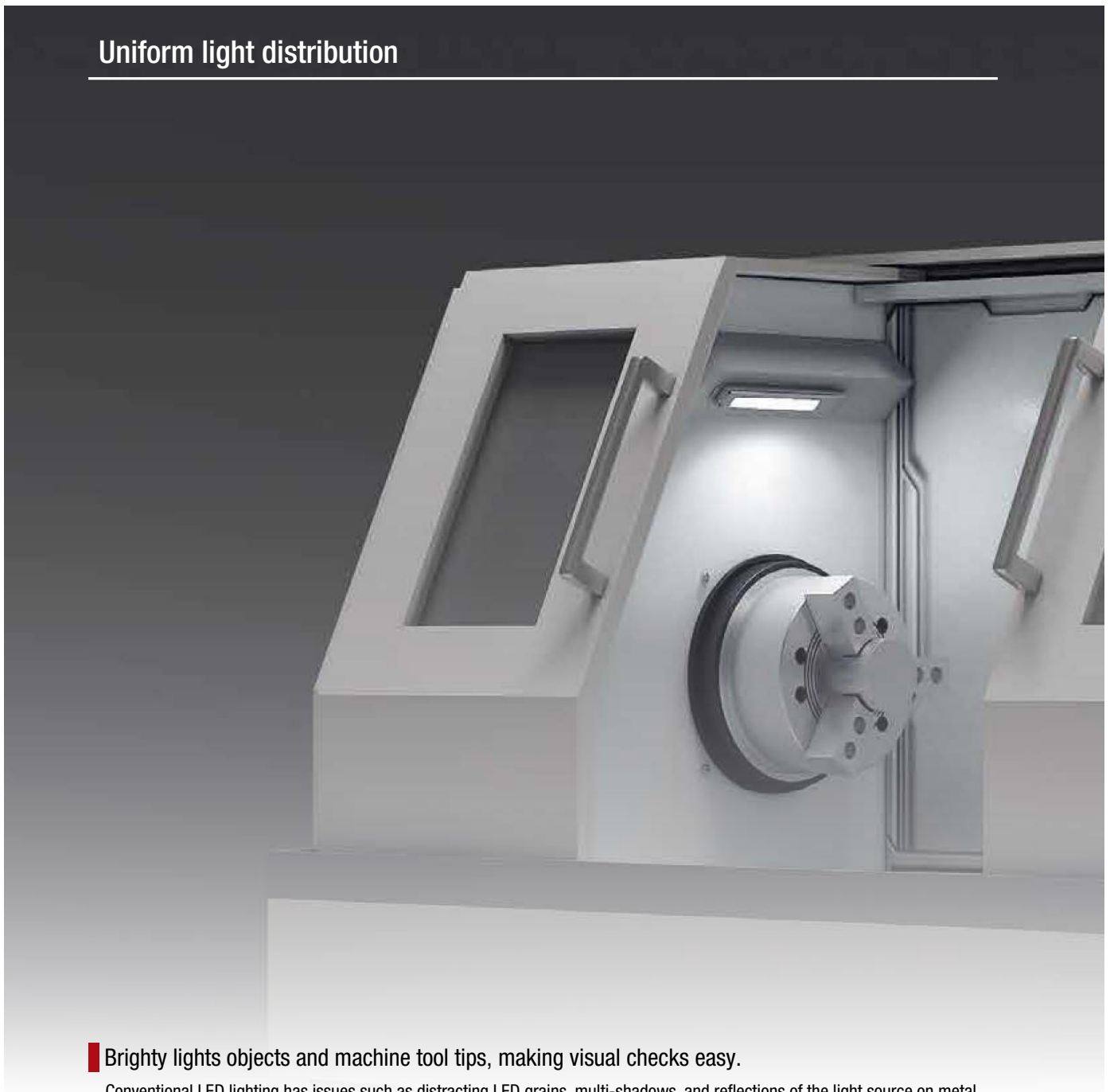

Brightly lights objects and machine tool tips, making visual checks easy.

Conventional LED lighting has issues such as distracting LED grains, multi-shadows, and reflections of the light source on metal objects or hairline texture. LF1D/LF2D's uniform light emitting face has less LED grains and reduces light source reflection/multi-shadows.

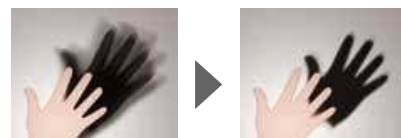
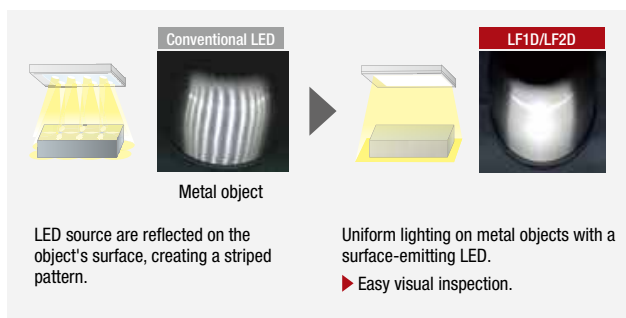

► Reduced multi-shadow makes visual inspection easy.



■ **Illuminates objects and periphery brightly. Easy maintenance.**

Provides wide-angle, high-illuminance lighting. Brightness required by the standard* is achieved. Target objects such as the tip of machine tools and its periphery are lit brighter, making it easier to check.

*EN1837: 1999 + A1: 2009, 4.2

At least 500 lx shall be provided when arranging lighting for machines.

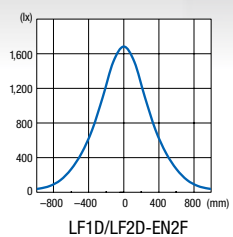
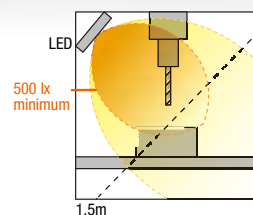

■ **Compliant with safety standard of machine tools**

Requirement for machine tools (stationary grinding machines)
ISO 16089; 5.8.e

When designing machinery, **lighting intensity, direction, glare**, etc. shall be taken into account.

When necessary, integral lighting shall be provided. Especially the following items shall be taken into account:

- 1) the required lighting intensity depends on the grinding operation to be performed. It shall be at least **300 lx** in the area to be observed and its immediate vicinity;
- 2) glare, **reflections and shadows**, e.g. from workpiece or machine parts, shall be avoided **as far as possible**;
- 3) the lighting source shall be positioned to **minimize its contamination** during machining.

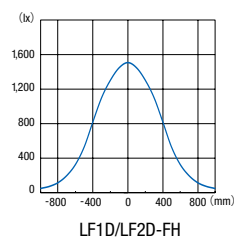

Robust and resistant against harsh environments

Excellent resistance against harsh environments. Suitable for use in machine tools.

Built with durable material (reinforced glass, stainless steel, aluminum diecast), LF1D/LF2D is resistant against flying chips. IP67F* degree of protection is achieved with an oil-proof gasket and IDEC's unique design. Can be used in environments subject to water and dust.

* Reinforced glass model
(LF1D/LF2D-EN: IP67G)

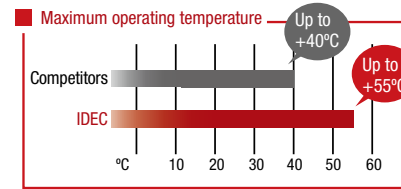

Wide operating temperature range enables use in harsh environments.

Easy maintenance

High-quality connection is achieved with a removable direct plug-in terminal block and spring clamp connections, allowing the user to detach the cable from housing. Installation and replacement are made easier.

• Connection Examples

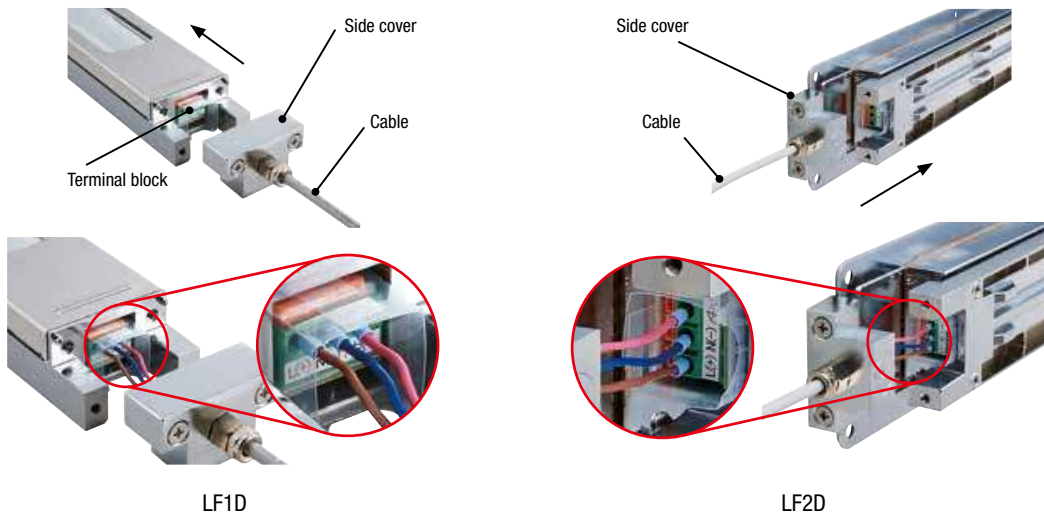

A wide range of models to suit your application

Surface mount

LF1D

Recessed mount

LF2D

* At 1m directly below

For small to middle size machines



NEW

To light machine tool tips and objects with high luminance.

Reduced reflection of light source



350 to 389 × 50 to 80 mm

1530 lm

Standard 1700 lx*
Diffused 1000 lx*

Standard/Diffused

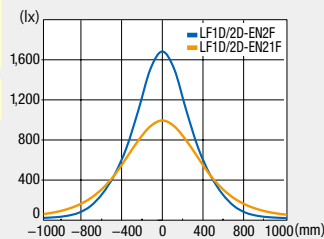

▶ Uniform light source/Slim model LF1D/2D-EN



To light inside the machine brightly and widely.

270 to 308 × 75 to 105 mm

1540 lm

1500 lx*

Brightly lights target objects and periphery

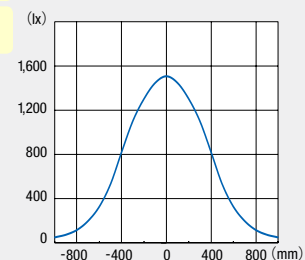

▶ Wide model LF1D/2D-FH

For miniature machines



Brightly lights machine tool tips and inside small machines

100 × 50 mm

560 lm

180 lx*

Wide 120° light distribution

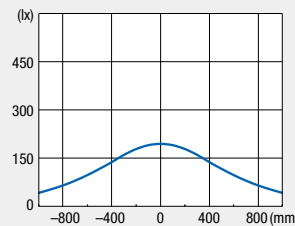

▶ Mini Model LF1D-C

For large machines



Optimal choice to replace fluorescent lighting of the entire area inside large machines.

365/510 × 84 mm

2000/3000 lm

560/840 lx*

Wide 120° light distribution

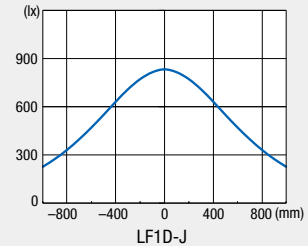

▶ Long Model LF1D-H/J

For lathing machine and other applications



Can be used in applications with dusts metal chips

134 to 1080 × 27.5 mm

95 to 1350 lx

At 0.5m directly below

- Wide variety of lengths
- IP65 waterproof/dustproof
- Fits small spaces

▶ LF1B-N

For details of LF1B-N, see IDEC's website.

LF1D/LF2D LED Illumination Units

Model

LF1D-C Mini model L=100mm

Package quantity: 1

Shape	Surface mount	
Illumination Surface	Reinforced glass	
Cable	Length	Part No.
Side	3m	LF1D-C2F-2W-330
	5m	LF1D-C2F-2W-350
Back	3m	LF1D-C2F-2W-430
	5m	LF1D-C2F-2W-450



• See website for details on approvals and standards.

LF1D-EN/LF2D-EN uniform light source, slim model (L = 390 mm/L = 389 mm)

Package quantity: 1

Model			LF1D-EN2F	LF2D-EN2F	LF1D-EN21F	LF2D-EN21F
Light Distribution			Standard		Diffused	
Shape			Surface mount	Recessed mount	Surface mount	Recessed mount
Illumination Surface			Reinforced glass			
Cable gland LF9Z-A11	Cable (5m) LF9Z-C05	Mounting bracket (*1) LF9Z-B11 LF9Z-B12	Part No.			
Without (cable gland hole on the side of LF1D)	—	—	LF1D-EN2F-2W	LF2D-EN2F-2W	LF1D-EN21F-2W	LF2D-EN21F-2W
		With	LF1D-EN2F-2W-101	—	LF1D-EN21F-2W-101	—
Without (cable gland hole on the back of LF1D)	—	—	LF1D-EN2F-2W-200	LF2D-EN2F-2W-200	LF1D-EN21F-2W-200	LF2D-EN21F-2W-200
		With	LF1D-EN2F-2W-201	—	LF1D-EN21F-2W-201	—
With (side)	—	—	LF1D-EN2F-2W-300	LF2D-EN2F-2W-300	LF1D-EN21F-2W-300	LF2D-EN21F-2W-300
		With	LF1D-EN2F-2W-301	—	LF1D-EN21F-2W-301	—
	With	—	LF1D-EN2F-2W-350	LF2D-EN2F-2W-A	LF1D-EN21F-2W-350	LF2D-EN21F-2W-A
		With	LF1D-EN2F-2W-A	—	LF1D-EN21F-2W-A	—
With (back)	—	—	LF1D-EN2F-2W-400	LF2D-EN2F-2W-400	LF1D-EN21F-2W-400	LF2D-EN21F-2W-400
		With	LF1D-EN2F-2W-401	—	LF1D-EN21F-2W-401	—
	With	—	LF1D-EN2F-2W-450	LF2D-EN2F-2W-450	LF1D-EN21F-2W-450	LF2D-EN21F-2W-450
		With	LF1D-EN2F-2W-451	—	LF1D-EN21F-2W-451	—

*1) LF1D only

LF1D-FH/LF2D-FH wide model (L = 310/L = 308 mm)

Package quantity: 1

Model			LF1D-FH	LF2D-FH
Shape			Surface mount	Recessed mount
Illumination Surface			Reinforced glass	
Cable gland LF9Z-A11	Cable (5m) LF9Z-C05	Mounting bracket (*1) LF9Z-B11 LF9Z-B12	Part No.	
Without (cable gland hole on the side of LF1D)	—	—	LF1D-FH2F-2W	LF2D-FH2F-2W
		With	LF1D-FH2F-2W-101	—
Without (cable gland hole on the back of LF1D)	—	—	LF1D-FH2F-2W-200	LF2D-FH2F-2W-200
		With	LF1D-FH2F-2W-201	—
With (side)	—	—	LF1D-FH2F-2W-300	LF2D-FH2F-2W-300
		With	LF1D-FH2F-2W-301	—
	With	—	LF1D-FH2F-2W-350	LF2D-FH2F-2W-A
		With	LF1D-FH2F-2W-A	—
With (back)	—	—	LF1D-FH2F-2W-400	LF2D-FH2F-2W-400
		With	LF1D-FH2F-2W-401	—
	With	—	LF1D-FH2F-2W-450	LF2D-FH2F-2W-450
		With	LF1D-FH2F-2W-451	—

• Polycarbonate illumination surface is available. Contact IDEC for details.

*1) LF1D only

LF1D-H/LF1D-J long model (L = 365 mm/L = 510 mm)

Package quantity: 1

Model		LF1D-H	LF1D-J
Shape		Surface mount	
Illumination Surface		Reinforced glass	
Cable location	Cable length	Ordering No.	
Side	5m	LF1D-H2F-2N-350	LF1D-J2F-2N-350
	1.5m + M12 connector	LF1D-H2F-2N-3B0	LF1D-J2F-2N-3B0
Back	5m	LF1D-H2F-2N-450	LF1D-J2F-2N-450
	1.5m + M12 connector	LF1D-H2F-2N-4B0	LF1D-J2F-2N-4B0

LF1D/LF2D LED Illumination Units

Specifications

Model	LF1D-C	LF1D-EN (surface mount) LF2D-EN (recessed mount)	LF1D-FH (surface mount) LF2D-FH (recessed mount)	LF1D-H LF1D-J
Style	Mini	Uniform light source Slim	Wide	Long L = 365 mm (LF1D-H) L = 510 mm (LF1D-J)
Rated Voltage	24V DC			
Voltage Range	21.6 to 26.4V DC			
Rated Power (typ.)	4.6W	10W	12.5W	18.4W (LF1D-H) 27.6W (LF1D-J)
Illumination Color	White			Neutral white
Color Temperature	5,700K			4,700K
Total Luminous Flux (typ.)	560 lm	1,530 lm	1,540 lm	2,000 lm (LF1D-H) 3,000 lm (LF1D-J)
Reference Illuminance (typ.) at 1m	180 lx	1,700 lx (standard distribution) 1,000 lx (diffused distribution)	1,500 lx	560 lx (LF1D-H) 840 lx (LF1D-J)
Insulation Resistance	100MΩ minimum (500V DC megger)			
Dielectric Strength	1,000V AC 50/60Hz, 1 minute			
Vibration Resistance (damage limits)	Frequency 5 to 55 Hz, amplitude 0.5 mm			
Shock Resistance (damage limits)	1,000m/s ²			
Operating Temperature	-30 to +55°C (no freezing)			
Operating Humidity	45 to 85 %RH (no condensation)			
Storage Temperature	-35 to +70°C (no freezing)			
Operating Atmosphere	No corrosive gas			
Light Source Life (*1)	50,000 hours (The illumination duration in which the illuminance maintains a minimum of 70% of the initial value. Ta=25°C, 45%RH max.)			
Degree of Protection (*2)	IP67 (all models), IP67F (*3), IP67G (*3), IP69K (LF1D only)			
Material	Housing: aluminum Front cover: stainless steel Lens: reinforced glass	Housing: diecast aluminum Front cover (LF1D): stainless steel Flange (LF2D): diecast aluminum Lens: reinforced glass	Housing: diecast aluminum Front cover (LF1D): stainless steel Flange (LF2D): diecast aluminum Lens: reinforced glass or polycarbonate (*4)	Housing: aluminum Front cover: stainless steel Lens: reinforced glass
Weight (approx.)	LF1D-C2F-2W-350: 420g	LF1D-EN2F-2W-A: 950g LF2D-EN2F-2W-A: 1,000g	LF1D-FH**-2W-A: 1,000g LF2D-FH**-2W-A: 1,050g	LF1D-H2F-2N-350: 1,200g (LF1D-H) LF1D-J2F-2N-350 : 1,600g (LF1D-J)
Illuminance Distribution (reference value/unit: cd/1000 lm)				

• LED modules and illumination units may vary in illumination colors and illuminance

*1) LED life depends on the operating environment. Ta = ambient temperature

*2) Waterproof and oil-proof characteristics guaranteed for conditions specified by IEC60529 (IP67), JIS C 0920 (IP67F/IP67G), and DIN40050-9 (IP69K).

*3) IP67F: LF1D-C/H/J, LF1D/LF2D-EN, LF1D/LF2D-FH (reinforced glass)
IP67G: LF1D/LF2D-EN

*4) The reinforced glass and polycarbonate illumination surfaces have the same appearance, but have different degrees of protection.

Cross-sectional direction of light distribution

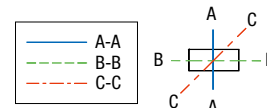

Internal Circuits

LF1D-C/LF1D-H/LF1D-J

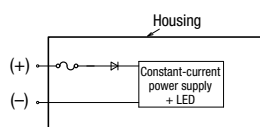

LF1D-EN/LF2D-EN

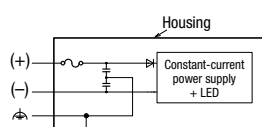

LF1D-FH/LF2D-FH

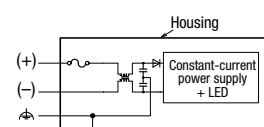

LF1D/LF2D LED Illumination Units

Dimensions

All dimensions in mm.

For mounting hole layout and the size of mounting screws on the back of illumination units, see the specification sheet and dimensions supplied with the product.

LF1D-C (mini model)

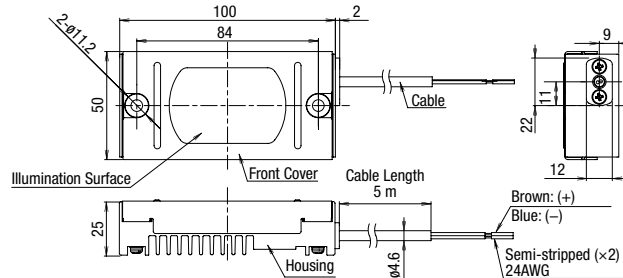

LF1D-EN (uniform light source, slim, surface mount)

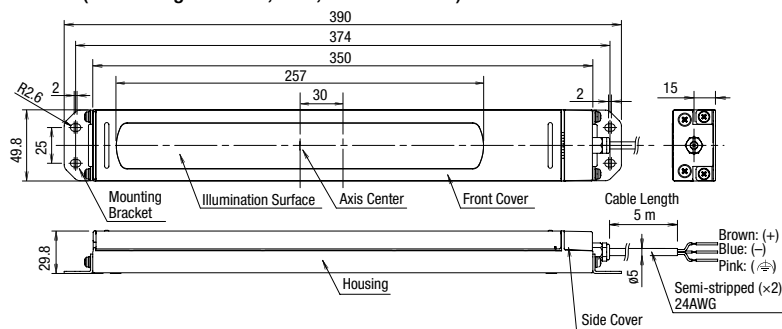

Terminal Block Wiring

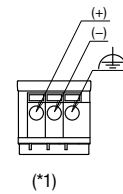

LF2D-EN (uniform light source, slim, recessed mount)

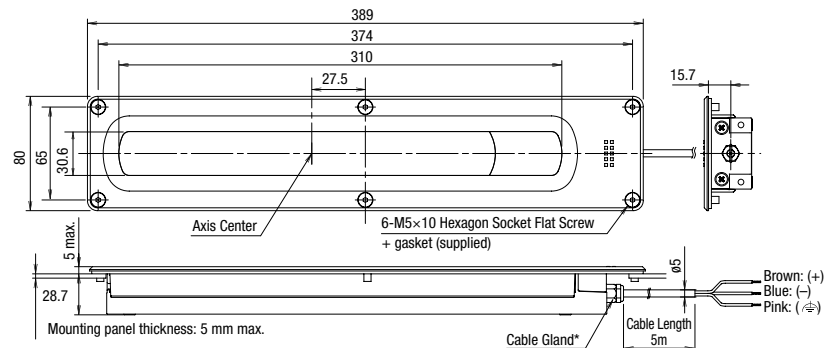

* When the cable gland is prepared by the user, make sure that the cable diameter is $\varnothing 20$ mm at maximum.

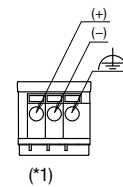

LF1D-FH (wide, surface mount)

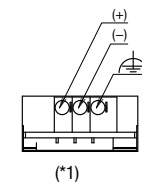
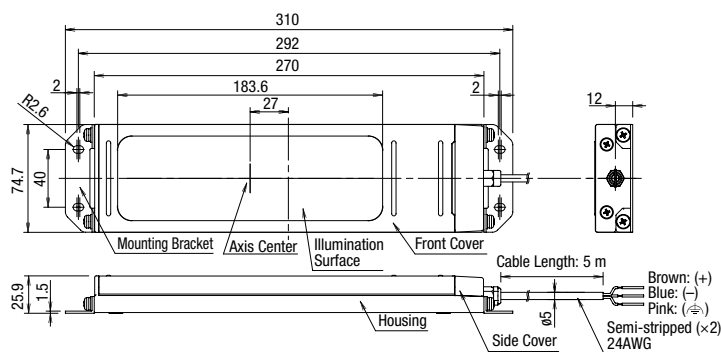

*1:
Use a ferrule of 0.25 to 0.75 mm².
Phoenix Contact:
AI 0.25-12BU
AI 0.34-12TQ
AI 0.5-12 WH
AI 0.75-12GY

LF1D/LF2D LED Illumination Units

Dimensions

All dimensions in mm.

For mounting hole layout and the size of mounting screws on the back of illumination units, see the specification sheet and dimensions supplied with the product.

LF2D-FH (wide, recessed mount)

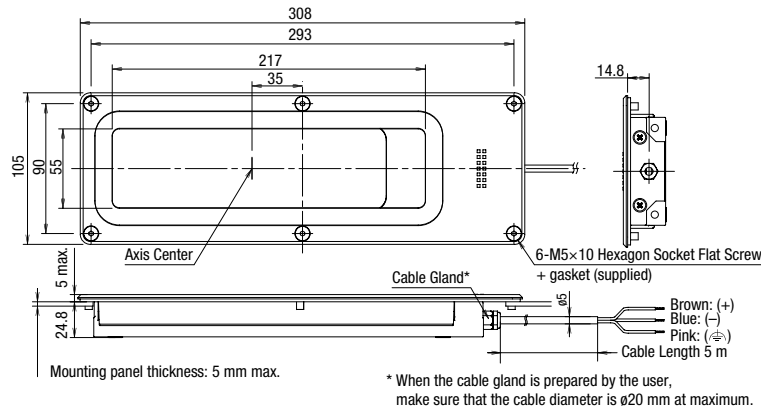

Terminal Block Wiring

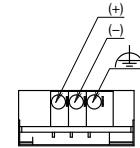

Use a ferrule of 0.25 to 0.75mm².
Phoenix Contact
AI 0.25-12BU
AI 0.34-12TQ
AI 0.5-12 WH
AI 0.75-12GY

LF1D-H (long, L = 365 mm)/LF1D-J (long, L = 510 mm)

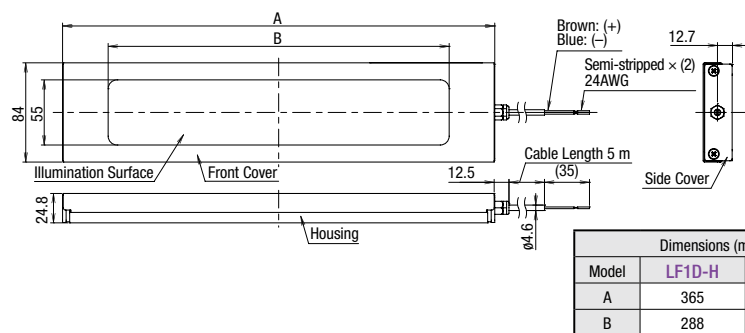

Connector Wiring

LF1D-H/J2F-2*-*B*
(M12 connector)

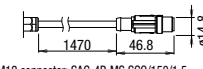

M12 connector: SAC-4P-MS SCO/150/1.5

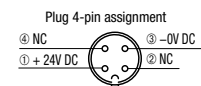

Dimensions (mm)		
Model	LF1D-H	LF1D-J
A	365	510
B	288	432

Use a connector that satisfies the degree of protection.
Recommended connector:
Phoenix Contact
SAC-4P-1.5-PUR/FS SCO

Accessories

All dimensions in mm.

Exclusively for LF1D-EN/FH, LF2D-EN/FH (uniform light source, slim/wide)

Package quantity: 1

Accessory	Material	Part No.	Remarks
Cable Gland	Brass	LF9Z-A11	M8, applicable wire size: ø3.5 to 5.5 mm
Mounting Bracket	Stainless steel	LF9Z-B11	Contains two (supplied with mounting screws)
		LF9Z-B12	Contains two (supplied with mounting screws)
Adjustable Angle Mounting Bracket	Stainless steel	LF9Z-1MDE1	Contains two (for right and left, supplied with mounting screws)
		LF9Z-1MDF1	
Cable	PVC shielded	LF9Z-C05	5 m

Dimensions

LF9Z-1MDE1

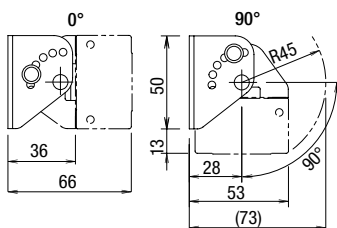

LF9Z-1MDF1

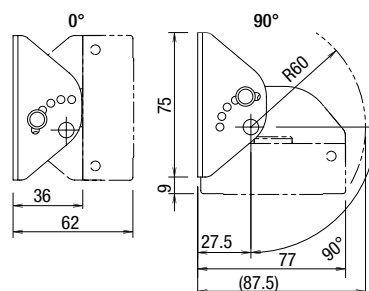

LF1D/LF2D LED Illumination Units

Safety Precautions

- Do not disassemble, repair, or modify LF1D/LF2D. Otherwise electric shock, fire, or malfunction may occur.
- Turn off power before wiring. Make sure that the temperature of LF1D/2D has lowered sufficiently before wiring.
- To prevent electric shock or damage, ensure that the wiring is correct.
- Do not stare directly into the LF1D/LF2D while it is lit, and do not project the light towards other people, otherwise their eyes may be injured.
- The LF1D/LF2D is a general-purpose industrial electric device.
- Ensure correct operating temperature. Otherwise rise in internal temperature may result in damage to the unit.
- Do not use in an application which may cause harm or injury to anyone or threaten life in case a malfunction or failure occurs.
- LF1D/LF2D is for indoor use only. Do not use outdoors, otherwise insulation failure, electric shock, or failure may result.

Operating Instructions

- LED modules and illumination units may vary in illumination colors and illuminance.
- Before designing equipment and powering up illumination units, confirm the specifications described in the instruction sheet.
- Apply voltage within the rated value, otherwise the LED elements may be damaged.
- Do not use or store in a location subjected to vibration and shock, otherwise electric shock or failure will result.
- Do not loosen screws, otherwise the protection characteristics will be impaired.
- To clean the cover, use a soft cloth with water or neutral detergent. Do not use solvents such as thinners, benzene, or alkaline, otherwise discoloration, deterioration, or decrease in strength may occur.
- When using this product in environments subject to dust and water, make sure that the wiring part of cable or wire are dustproof/waterproof. Otherwise leakage, electric shock, or failure may be caused.
- Do not use in the following locations:
 - * Subject to corrosive gases, volatile gases, flammable gases, or chemicals that could affect the safety and reliability of the product.
 - * Subject to electric or magnetic field
 - * Subject to flammable substances
 - * Outdoors
 - * Exposed to direct sunlight, near heaters, high temperatures
 - * Exposed to salt water
 - * Subject to condensation or freezing, such as cold storage warehouse or air cooler outlet (make sure that condensation or freezing do not occur)
 - * Exposed to ozone, radiation, UV or other locations where safety and reliability of the product.
- When using LF1D/LF2D as a UL/c-UL listed product, use a Class 2 power supply.

Warranty

- IDEC warrants LF1D/LF2D to be free from defects in material and workmanship under normal and proper use for a period one (1) year from date of shipment. The warranty period is reduced to six (6) months if LF1D/2D is run continuously over 20 hours. Any defected product will either be replaced or repaired, not including the expense required for mounting, replacing, or installation work.
- Warranty does not apply if LF1D/2D is not operated under conditions described in the instruction sheet or user's manual.

- Illumination units have a product life.
- Because internal elements deteriorate after 8 to 10 years of installation even if they have no defects in appearance, inspection and/or replacement are recommended. Operation condition: temperature 30°C, 3,000-hour operation per year (10 hours per day). (JIS C 8105-1)
- Product life is shortened under high operating temperature or when it is lit for long hours.
- Inspection and/or cleaning by user every 6 months is recommended.
- Inspection by contractors is recommended every 3 years.
- Do not use LF1D/LF2D for a long time without inspection, otherwise smoke, fire, or electric shock may occur.

IDEC CORPORATION

 www.idec.com

Head Office

6-64, Nishi-Miyahara-2-Chome, Yodogawa-ku, Osaka 532-0004, Japan

USA	IDEC Corporation	Tel: +1-408-747-0550	opencontact@idec.com	Hong Kong	IDEC Izumi (H.K.) Co., Ltd.	Tel: +852-2803-8989	info@hk.idec.com
Germany	APEM GmbH	Tel: +49-40-25 30 54 - 0	service@eu.idec.com	China/Shanghai	IDEC (Shanghai) Corporation	Tel: +86-21-6135-1515	idec@cn.idec.com
Singapore	IDEC Izumi Asia Pte. Ltd.	Tel: +65-6746-1155	info@sg.idec.com	China/Shenzhen	IDEC (Shenzhen) Corporation	Tel: +86-755-8356-2977	idec@cn.idec.com
Thailand	IDEC Asia (Thailand) Co., Ltd.	Tel: +66-2-392-9765	sales@th.idec.com	China/Beijing	IDEC (Beijing) Corporation	Tel: +86-10-6581-6131	idec@cn.idec.com
Australia	IDEC Australia Pty. Ltd.	Tel: +61-3-8523-5900	sales@au.idec.com	Japan	IDEC Corporation	Tel: +81-6-6398-2527	marketing@idec.co.jp
Taiwan	IDEC Taiwan Corporation	Tel: +886-2-2698-3929	service@tw.idec.com				

Specifications and other descriptions in this brochure are subject to change without notice.

Information in this brochure is current as of July 2019.

2019 IDEC Corporation, All Rights Reserved.

EP1626-2

