

MICROSmart
Programmable Logic Controllers

FC6A



ANSI/ISA 12.12.01 approved for hazardous locations.
Certified for marine use by Lloyd's Register (LR),
Germanischer Lloyd (GL), American Bureau of Shipping (ABS),
Det Norske Veritas (DNV), and NIPPON KAIJI KYOKAI (NK).



Plus



All-in-One

Bluetooth (Wireless)

PLC can be controlled or monitored from smartphones and tablets using a Bluetooth communication cartridge.

Remote control with Web Server function

Use pre-installed, program-less simple pages or design your own custom pages using Web Page Editor.

Wide range of applications

Web server, Send E-mail, FTP server/client, and user communication functions are achieved with the Ethernet communication, enabling to manage the control and information systems at the same time.

New application possibilities

CAN J1939 communication and BACnet/IP protocol available, expanding the possibility of PLC applications.

A maximum of 10 racks and 63 expansion modules can be connected.

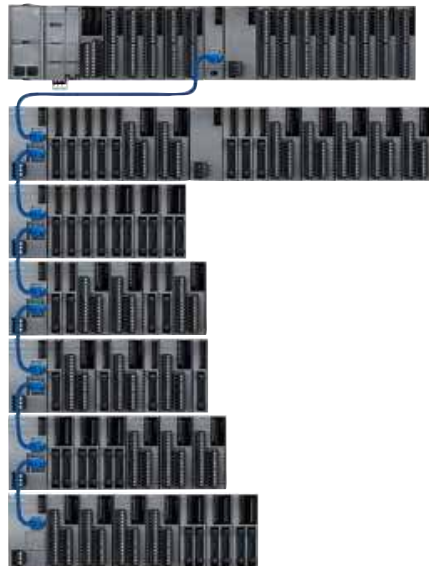

MICROSmart FC6A Plus

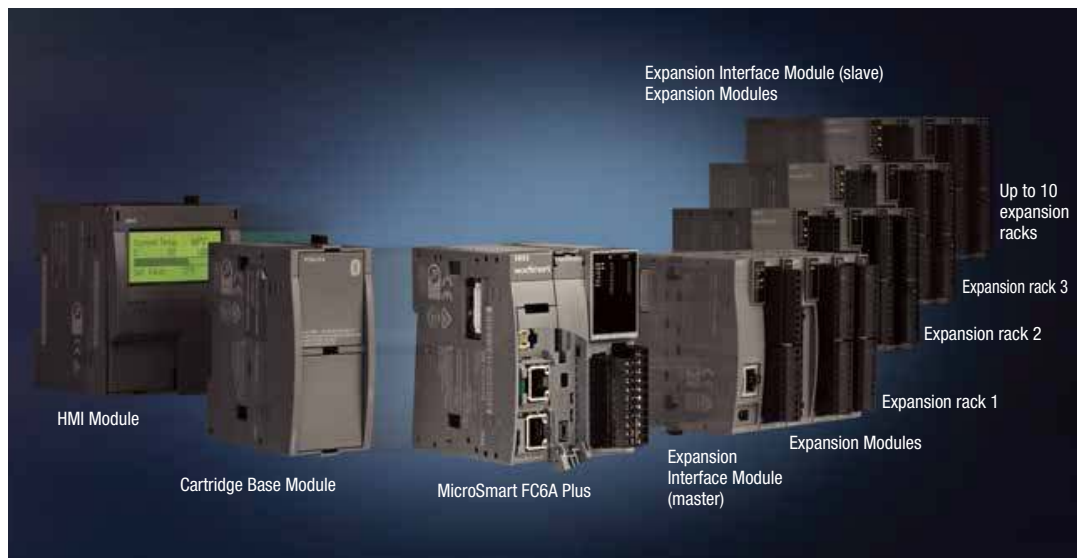

More Power. More Performance. More Connectivity.

Latest evolution. The MicroSmart FC6A Plus expands the limits of productivity, allowing for controlling not only large-size machines, but also entire small-size production lines.

- Up to 2,060 I/O (incl. a maximum of 511 analog I/O)
- Extremely fast basic instruction execution of 21 ns
- User program size: 800 KB (100,000 steps)
- BACnet/IP protocol available

The MicroSmart FC6A Plus can also handle large programs such as positioning, PID, flow totalization and recipes.

A maximum of 2,060 digital/analog I/O (All-in-One CPU module: 528 I/O), 33 ports of serial communication, PID control using PID module with up to 126-I/O expandability. Can be used in larger system configurations than conventional ones where micro PLCs are used.

* Maximum expansion of All-in-One CPU module:

System configuration of DIO+AIO (528 I/O), serial communication (9 I/O), temperature control (up to 30 I/O) using temperature module is possible.

Multi-point system configuration can be set up flexibly with the Ethernet cable and expansion interface module (unibody master/slave). Flexibly configure up to 10 expansion racks (15 modules max. per rack) to fit the control panels or installation sites.

Only a small number of points, such as one or two, can be added easily by using cartridges. Optional spring clamp block connector is available to reduce wiring.

IDEC's ever-evolving MicroSmart FC6A Plus reduces wiring and labor, and creates robust and stylish control panels.



Download catalogs and CAD from <http://eu.idec.com/downloads>

Controllers

APEM

Switches & Pilot Lights

Control Boxes

Emergency Stop Switches
Enabling Switches

Safety Products

Explosion Proof

Terminal Blocks

Relays & Sockets

Circuit Protectors

Power Supplies

LED Illumination

Controllers

Operator Interfaces

Sensors

AUTO-ID

FC6A

FT1A

FL1F

L-006

MICROSmart FC6A All-in-One

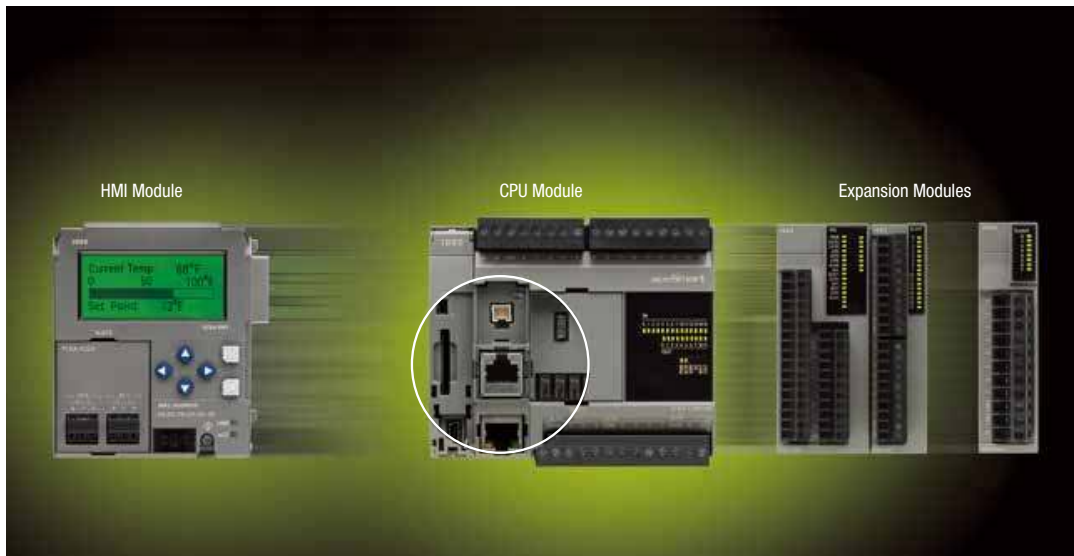

Power, Performance, and Connectivity

**The MicroSmart FC6A All-in-One.
High performance and easy programming.**

- Up to 528 I/O (incl. a maximum of 511 analog I/O)
- Extremely fast basic instruction execution of 42 ns
- User program size: 640 KB (80,000 steps)
- Easy and quick programming

Parameters such as the status of peripheral input devices connected to the PLC, results of logical operation to peripheral output devices. These parameters need to be checked and changed on-site. Simplify your work by using the FC6A's HMI module. No PC required.

Perform run/stop of CPU module, parameter check/change, calendar display, and clock setting using the LCD with 32 characters × 4 lines and six buttons. Ethernet ports can be used for Email and Web Server Functions.

With cartridges available in 10 types, a small number of I/O and communication port can be added easily in a limited space. The FC6A-PC4 Bluetooth communication cartridge enables wireless communication with barcode readers and other peripheral devices. Eliminating the need to adjust the cable length on-site shortens the time for installation and maintenance.

Adaptive Design



NEW
BACnet/IP

Plus

Dual Ethernet ports

One port can be configured for information system such as FTP, Web Server, and Email functions, and the second port can be configured for a control network including Modbus TCP, to provide you with powerful maintenance and control capabilities. BACnet/IP also supported. (System software ver 1.20 or later)



Plus All-in-One

RJ45 Ethernet Port

Supports the Modbus TCP protocol, and internet connections such as Web Server and Email functions for remote monitoring and control. (All-in-One: HMI module is required.)



Plus All-in-One

SD Memory

SD card for data logging, program storage/transfer, or user program updating.



Plus All-in-One

Replaceable Battery

Battery can be replaced by the user, enabling predictive maintenance.



Plus All-in-One

Pull-up/down Removable Power Supply Terminal

Pull-up/down terminal reduces wiring (patented).



Plus All-in-One

USB Port

Can be used to transfer user programs from WindLDR to CPU module and for monitoring, without the need of power supply.



Plus All-in-One

Removable Terminal Blocks

Simplifies wiring, installation, and module replacement—just wire the terminal block plugged into a module.



Plus All-in-One
9 ports max.

Up to 33 Serial Ports

Using a combination of communication cartridges and FC6A-SIF52 modules, up to 33 serial ports can be utilized.



All-in-One

RJ45 RS232C/485 Serial Port

Supports Modbus RTU, user communication, maintenance communication, and data link communication.



Plus

Reduced Wiring

Spring clamp terminal available.



Plus All-in-One

Digital/Analog/Communication Cartridges

Digital cartridge: 3 types (4-point digital input/4-point transistor output)
Analog cartridge: 4 types (2-point analog input/output)
Communication cartridge: 3 types (Serial/Bluetooth communication)



Plus All-in-One

I/O Modules

Digital input module: 5 modules
Digital output module: 10 modules
Digital mixed I/O module: 2 modules
Analog I/O module: 12 modules

Controllers

APEM

Switches & Pilot Lights

Control Boxes

Emergency Stop Switches
Enabling Switches

Safety Products

Explosion Proof

Terminal Blocks

Relays & Sockets

Circuit Protectors

Power Supplies

LED Illumination

Controllers

Operator Interfaces

Sensors

AUTO-ID

FC6A

FT1A

FL1F



Download catalogs and CAD from <http://eu.idec.com/downloads>

L-008

Unmatched Performance

APEM

Switches & Pilot Lights

Control Boxes

Emergency Stop Switches

Enabling Switches

Safety Products

Explosion Proof

Terminal Blocks

Relays & Sockets

Circuit Protectors

Power Supplies

LED Illumination

Controllers

Operator Interfaces

Sensors

AUTO-ID

FC6A

FT1A

FL1F



Up to 2,060 I/O

A maximum of 511 analog I/O. (when using a 32-point FC6A Plus CPU module + an expansion interface module + 32-point digital I/O modules (63 modules) + digital cartridges (3 cartridges) + a cartridge base module + an HMI module)



Positioning Control

Equipped with features needed for simple positioning control, such as zero return and 2-axis linear interpolation.



Expanded Memory

Program memory size is 800KB (100,000 steps) maximum with 2,000 timers, 512 counters, and 260,000 data registers. Double the capacity of conventional PLCs. This allows handling of large and complex programs such as PID, flow totalization and recipes.



Improved PID Algorithm

A new and improved PID algorithm enables cascade control that needs complex programming.



Fast Processing Speed

Processing speed is 4 times faster than IDEC FC5A MicroSmart Pentra.



Modbus TCP, RTU Protocols

These two leading industrial communication protocols are supported in the CPU module and FC6A-SIF52 communication module. Communication monitor shortens the debugging time, and communication to other devices is quick and seamless.



Fast I/O Refresh

Expansion I/O refresh is 0.1 ms with four digital I/O modules + one analog I/O module.



Automatic Email Function

Remote access to system status using web browser. Get periodic report and error notification alarm anywhere with Email function.



High-Speed Outputs

Advanced instructions:
ARAMP: Advanced Ramp
JOG: Pulse with direction
ABS: Set the origin



Upgradable Software

System software and user programs are upgradable through WindLDR, data file manager, or SD memory.



Time-Base Applications

Real-time clock is built in. Obtain time from SNTP server.



iOS/Android Apps: WindEDIT

Perform status check, run/stop check and operation, parameter check/change, user program download/upload of FC6A with your smart phone or tablet without PC or HMI module. Files/folders in SD memory can be displayed as a list, downloaded, uploaded, and deleted. Format operation is also possible.

Industrial Internet of Things



Controllers

- APEM
- Switches & Pilot Lights
- Control Boxes
- Emergency Stop Switches
- Enabling Switches
- Safety Products
- Explosion Proof
- Terminal Blocks
- Relays & Sockets
- Circuit Protectors
- Power Supplies
- LED Illumination
- Controllers**
- Operator Interfaces
- Sensors
- AUTO-ID
- FC6A
- FT1A
- FL1F

Wireless Communication

Wireless communication achieved with Bluetooth cartridge. Use the iOS/Android App to monitor/change parameters, upgrade user program, and monitor logged data in the SD memory without opening a control panel. System upgrade and predictive maintenance cannot be more easier. Use your smart phone or tablet to wirelessly communicate via the Bluetooth cartridge of the FC6A, or over wifi or internet. The FC6A microsite links to App Store and Google Play application download sites.



App Store



Google Play

FTP Server/Client Functions

Store real time on-site information in the host FC6A or PC to manage operation effectively. Because systems in multiple FC6A can be upgraded at the same time, downtime and management are minimized.

Email Function

Connecting the Ethernet port on the CPU or on the optional HMI module to the internet enables email notification to quickly inform personnel of alarms and events, allowing them to take remedial action quickly. Can be used with third-party email servers such as Gmail and Yahoo.

SCADA Monitoring and Control

Connecting the Ethernet or one of the serial communication ports on the FC6A to a SCADA system, all data required for display screen, trend, and troubleshooting can be sent to the SCADA system. Sending the data or commands from the SCADA system to the CPU enables remote management.

Security/FTP/Web Server/App

Up to 16 user accounts can be set up by setting user names and passwords. Ensure security by separately setting the monitoring and operation authorities.



Download catalogs and CAD from <http://eu.idec.com/downloads>

L-010

Multiple Communication Options

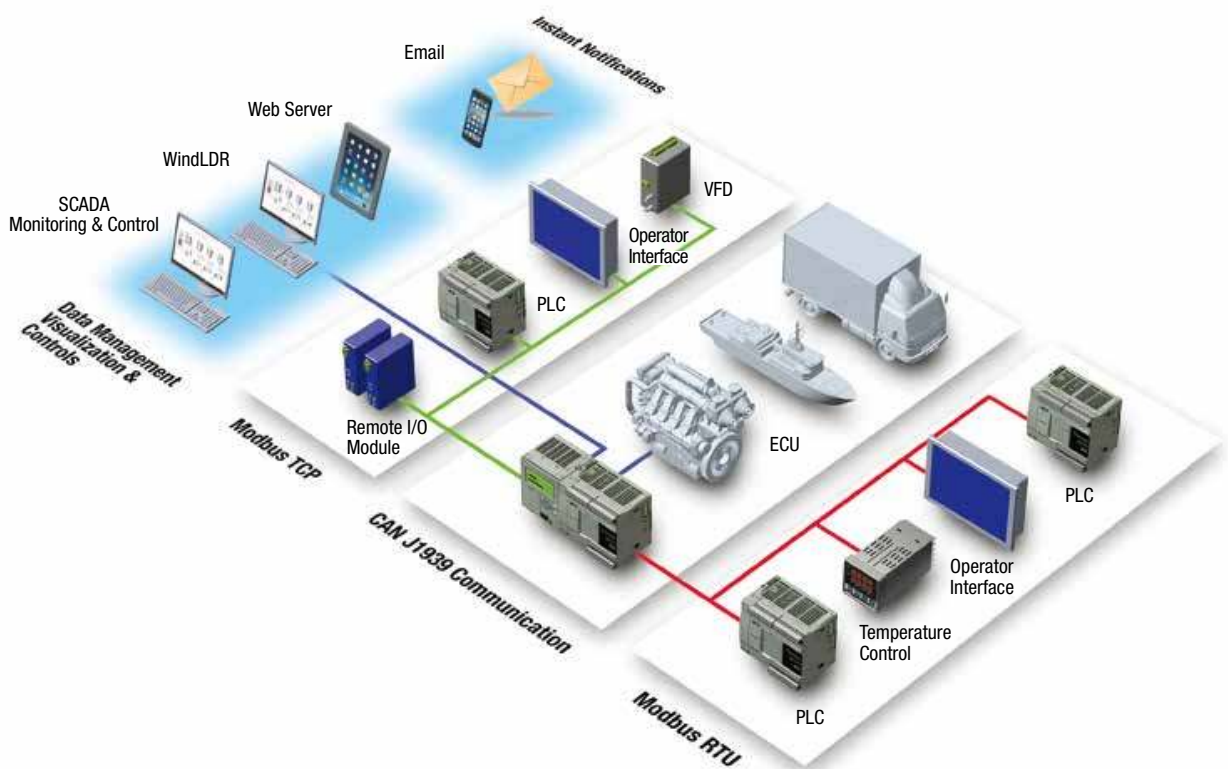

Email Function

Values stored in the FC6A can be sent in Email format. Up to 255 templates can be configured to multiple recipients. Third-party email servers such as Gmail or Yahoo supported.



Modbus TCP/RTU Protocol

Supports both protocols and can be configured as a master or slave.



BACnet/IP Protocol

This leading building automation control protocol is supported in the Plus CPU module. Optimal decentralized control is achieved by operating as a controller with a B-ASC profile that communicates with a host device. Efficient and energy-saving building control can be realized by gatewayless communication.



CAN J1939 Protocol

Commonly used in diesel power applications, in vehicle networks for trucks, buses, agriculture & forestry machinery, and marine navigation systems.

Manage your production... from anywhere

Micro PLC with Web Server Function

Equipped on MicroSmart FC6A Plus as standard

Web Page Editor makes it simple to create professional and dynamic web pages to monitor and control your system remotely from PC, smart phone or tablet, via a web browser.



WindLDR Programming Software

The dialog-driven programming tool combines logic and intuition with an incredibly easy-to-use interface. No knowledge in ladder programming required. Just use the configurator, shortcut key, simulation and monitor functions to make programs quickly.

Web Page Editor: No HTML Programming Required

Wind LDR 8.2 or later version has a new Web Page Editor, which makes it simple to create professional and dynamic web pages to monitor and control the FC6A, with no HTML or Java Script knowledge.

Symbol Factory: Over 7,000 Images

With over 7,000 pre-built practical images that can be imported, you can construct a professional web page in minutes.

Parameter Setting

Want to create a bar graph, gauge, pie chart, trend chart, pilot light, slider, pushbutton or other object on your web page? Just pick the object, drop it on the screen. Data register values of the FC6A can be displayed, and parameters can also be changed on the web page.

Note: For Web Server Function and Email Function of the FC6A All-in-One Model, use FC6A-PH1 HMI module.

Controllers

APEM

Switches & Pilot Lights

Control Boxes

Emergency Stop Switches
Enabling Switches

Safety Products

Explosion Proof

Terminal Blocks

Relays & Sockets

Circuit Protectors

Power Supplies

LED Illumination

Controllers

Operator Interfaces

Sensors

AUTO-ID

FC6A

FT1A

FL1F



Download catalogs and CAD from <http://eu.idec.com/downloads>

L-012

Compare FC6A Models

	FC6A Plus CPU Module		FC6A All-in-One CPU Module			
Number of I/O	16 I/O	32 I/O	16 I/O	24 I/O	40 I/O	CAN J1939: 40 I/O
Shape						
Rated Power Voltage	24V DC	24V DC	24V DC 100 to 240V AC	24V DC 100 to 240V AC	12V DC 24V DC 100 to 240V AC	12V DC 24V DC 100 to 240V AC
Program Capacity	800KB (100,000 steps)	800KB (100,000 steps)	384KB (48,000 steps)	384KB (48,000 steps)	384KB (48,000 steps)	640KB (80,000 steps)
Expansion Interface Modules (Max.)	63 modules	63 modules	12 modules	15 modules	15 modules (12V DC Type: None)	15 modules (12V DC Type: None)
Maximum Digital I/O	2,044	2,060	404	508	528 (12V DC Type: 48)	528 (12V DC Type: 48)
Maximum Analog I/O	511	511	101	125	127 (12V DC Type: 7)	126 (12V DC Type: 7)
Communication Protocol	Modbus TCP Modbus RTU User Communication (Serial, TCP/UDP) FTP Client/Server BACnet/IP Bluetooth (SPP, iAP) (optional cartridge)	Modbus TCP Modbus RTU User Communication (Serial, TCP/UDP) FTP Client/Server BACnet/IP Bluetooth (SPP, iAP) (optional cartridge)	Modbus TCP Modbus RTU User Communication (Serial, TCP) Bluetooth (SPP, iAP) (optional cartridge)	Modbus TCP Modbus RTU User Communication (Serial, TCP) Bluetooth (SPP, iAP) (optional cartridge)	Modbus TCP Modbus RTU User Communication (Serial, TCP) Bluetooth (SPP, iAP) (optional cartridge)	CAN J1939 Modbus TCP Modbus RTU User Communication (Serial, TCP) Bluetooth (SPP, iAP) (optional cartridge)
IoT Functions	iOS, Android Apps Web Server Functions Email Function	iOS, Android Apps Web Server Functions Email Function	iOS, Android Apps Web Server Functions (*1) Email Function (*1)	iOS, Android Apps Web Server Functions (*1) Email Function (*1)	iOS, Android Apps Web Server Functions (*1) Email Function (*1)	iOS, Android Apps Web Server Functions (*1) Email Function (*1)
Serial Port Extensibility	33	33	7	7	8	8
Cartridge	3 (*2)	3 (*2)	3 (*2)	3 (*2)	3 (*2)	3 (*2)

*1) Using FC6A-PH1 module

*2) Using HMI module. For All-in-One, Analog and digital cartridges can be added to the HMI module.

For Plus, Analog, digital, communication cartridges can be added.

(All-in-One CPU module System software Ver. 1.60 or later)
(Plus CPU module System software Ver. 1.00 or later)
(HMI module System software Ver. 1.52 or later)

MICROSmart FC6A Micro Programmable Logic Controllers

Controllers

Lineup

FC6A Plus CPU Modules

Package Quantity: 1

High-speed Counter Pulse Output	Power	Input	Output	Interface	I/O Points	Part No.
<ul style="list-style-type: none"> High-speed counter Maximum input frequency: 100 kHz Pulse output (*1) Maximum output frequency: 100 kHz 	24V DC	24V DC (Sink/Source)	Relay Output 2A (240VAC-2A, 30V DC-2A)	Port 1 (USB) Port 2 (Ethernet) Port 3 (Ethernet)	16 points (8/8) 32 points (16/16)	FC6A-D16R1CEE
			Transistor Source Output 0.5A			FC6A-D16P1CEE
			Transistor Sink Output 0.5A			FC6A-D16K1CEE
			Transistor Source Output 0.1A			FC6A-D32P3CEE
			Transistor Sink Output 0.1A			FC6A-D32K3CEE

FC6A All-in-One CPU Modules

Package Quantity: 1

High-speed Counter Pulse Output	Power	Input	Output	Interface	I/O Points	Part No.
<ul style="list-style-type: none"> High-speed counter Maximum input frequency: 100 kHz Pulse output (*1) Maximum output frequency: 100 kHz 	100V to 240V AC (50/60Hz)	24V DC (Sink/Source)	Relay Output 2A, 240V AC-2A, 30V DC-2A	Port 1 (USB) Port 2 (RS232C/RS485) Port 3 (Ethernet)	16 points (9/7)	FC6A-C16R1AE
					24 points (14/10)	FC6A-C24R1AE
					40 points (24/16)	FC6A-C40R1AE
					16 points (9/7)	FC6A-C16R1CE
					16 points (9/7)	FC6A-C16P1CE
	16 points (9/7)		FC6A-C16K1CE			
	24 points (14/10)		FC6A-C24R1CE			
	24 points (14/10)		FC6A-C24P1CE			
	24 points (14/10)		FC6A-C24K1CE			
	40 points (24/16)		FC6A-C40R1CE			
	40 points (24/16)		FC6A-C40P1CE			
	40 points (24/16)		FC6A-C40K1CE			
	40 points (24/16)		FC6A-C40R1DE			
	40 points (24/16)		FC6A-C40P1DE			
	40 points (24/16)		FC6A-C40K1DE			

CAN J1939 All-in-One FC6A CPU Modules

Package Quantity: 1

High-speed Counter Pulse Output	Power	Input	Output	Interface	I/O Points	Part No.
<ul style="list-style-type: none"> High-speed counter Maximum input frequency: 100 kHz Pulse output (*1) Maximum output frequency: 100 kHz 	100V to 240V AC (50/60Hz)	24V DC (Sink/Source)	Relay Output 2A, 240V AC-2A, 30V DC-2A	Port 1 (USB) Port 2 (CAN) Port 3 (Ethernet)	40 points (24/16)	FC6A-C40R1AEJ
						24V DC
	FC6A-C40P1CEJ					
	FC6A-C40K1CEJ					
	FC6A-C40R1DEJ					
	12V DC					12V DC (Sink/Source)
FC6A-C40K1DEJ						

*1) Transistor output model only

- APEM
- Switches & Pilot Lights
- Control Boxes
- Emergency Stop Switches
- Enabling Switches
- Safety Products
- Explosion Proof
- Terminal Blocks
- Relays & Sockets
- Circuit Protectors
- Power Supplies
- LED Illumination
- Controllers**
- Operator Interfaces
- Sensors
- AUTO-ID
- FC6A
- FT1A
- FL1F



Download catalogs and CAD from <http://eu.idec.com/downloads>

L-014

FC6A Micro Programmable Logic Controllers

Digital Input Modules

Package Quantity: 1

Input Points	Terminal	Part No.
8 points DC	Removable, 5.08mm pitch, 11-pin, screw fastened type connector	FC6A-N08B1
16 points DC	Removable, 3.81mm pitch, 10-pin, screw fastened type connector	FC6A-N16B1
16 points DC	20-pin MIL connector	FC6A-N16B3
32 points DC		FC6A-N32B3
8 points AC	Removable, 5.08mm pitch, 11-pin, screw fastened type connector	FC6A-N08A11

APEM

Digital Output Modules

Package Quantity: 1

Output Points	Terminal	Part No.
8 points Relay Output	Removable, 5.08mm pitch, 11-pin, screw fastened type connector	FC6A-R08B1
16 points Relay Output	Removable, 3.81mm pitch, 10-pin, screw fastened type connector	FC6A-R16B1
8 points Transistor Sink Output	Removable, 5.08mm pitch, 11-pin, screw fastened type connector	FC6A-T08K1
8 points Transistor Source Output		FC6A-T08P1
16 points Transistor Sink Output	Removable, 3.81mm pitch, 10-pin, screw fastened type connector	FC6A-T16K1
	20-pin MIL connector	FC6A-T16K3
16 points Transistor Source Output	Removable, 3.81mm pitch, 10-pin, screw fastened type connector	FC6A-T16P1
	20-pin MIL connector	FC6A-T16P3
32 points Transistor Sink Output		20-pin MIL connector
32 points Transistor Source Output	FC6A-T32P3	

Switches & Pilot Lights

Control Boxes

Emergency Stop Switches

Enabling Switches

Safety Products

Explosion Proof

Terminal Blocks

Relays & Sockets

Circuit Protectors

Power Supplies

LED Illumination

Controllers

Operator Interfaces

Sensors

AUTO-ID

FC6A

FT1A

FL1F

Digital Mixed I/O Modules

Package Quantity: 1

Input	Output	I/O Points	Terminal	Part No.
24V DC (Sink/Source)	Relay Output 240V AC/30V DC, 2A	8 (4 in/4 out)	Removable, 5.08mm pitch, 11-pin, screw fastened type connector	FC6A-M08BR1
		24 (16 in/8 out)	Removable, 3.81mm pitch, 11-pin, screw fastened type connector	FC6A-M24BR1
			Removable, 3.81mm pitch, 17-pin, screw fastened type connector	

Analog I/O Modules

Package Quantity: 1

Name	Input	Output	I/O Points	Terminal	Part No.
Analog Input Module	Voltage (0 to 10V, -10 to +10V) Current (0 to 20mA, 4 to 20mA)	—	2 inputs	Removable, 5.08mm pitch, 8-pin, screw fastened type connector	FC6A-J2C1
			4 inputs		FC6A-J4A1
			8 inputs		FC6A-J8A1
	Voltage (0 to 10V, -10 to +10V) Current (0 to 20mA, 4 to 20mA) Thermocouple (J, K, R, S, B, T, N) Resistance Thermometer (Ni100, Ni1,000, PT100, PT1,000)		4 inputs	Removable, 3.81mm pitch, 10-pin, screw fastened type connector	FC6A-J4CN1
			Isolated between channels 4 inputs		FC6A-J4CH1Y
Thermocouple (K, J, R, S, B, E, T, N, C)	8 inputs	FC6A-J8CU1			
Analog Output Module	—	Voltage (0 to 10V, -10 to +10V) Current (0 to 20mA, 4 to 20mA)	2 outputs	Removable, 5.08mm pitch, 11-pin, screw fastened type connector	FC6A-K2A1
	—		4 outputs		FC6A-K4A1
Analog I/O Module	Voltage (0 to 10V, -10 to +10V) Current (0 to 20mA, 4 to 20mA)	Voltage (0 to 10V, -10 to +10V) Current (0 to 20mA, 4 to 20mA)	4 inputs/2 outputs	Removable, 3.81mm pitch, 10-pin, screw fastened type connector	FC6A-L06A1
	Voltage (0 to 10V, -10 to +10V) Current (0 to 20mA, 4 to 20mA) Thermocouple (K, J, R, S, B, E, T, N, C) Resistance Thermometer (Ni100, Ni1,000, PT100, PT1,000)		2 inputs/1 output		

Analog I/O Modules (PID)

Package Quantity: 1

Name	Input	Output	I/O Points	Terminal	Part No.
PID Module	Voltage (0-1V, 0-5V, 1-5V, 0-10V) Current (0-20mA, 4-20mA) Thermocouple (K, J, R, S, B, E, T, N, PL-II, C) Resistance Thermometer (PT100, JPT100)	Relay output	2 analog inputs 2 relay outputs	Removable, 3.81mm pitch 11-pin, screw fastened type connector 17-pin, screw fastened type connector	FC6A-F2MR1
		Voltage output (12V, transistor protect source output) Current (4 to 20mA, analog output)	2 analog inputs 2 analog/digital outputs		FC6A-F2M1

FC6A Micro Programmable Logic Controllers

Controllers

Lineup

HMI Module

Package Quantity: 1

Name	Connectable CPU Module			Part No.
	Plus	All-in-One	CAN J1939 All-in-One	
HMI Module	Yes	Yes	Yes	FC6A-PH1

Expansion Interface Module

Package Quantity: 1

Name	Connectable CPU Module			Part No.
	Plus	All-in-One	CAN J1939 All-in-One	
Unibody Type	Yes	Yes	Yes	FC6A-EXM2
Separate Master Type	Yes	No	No	FC6A-EXM1M
Separate Slave Type	Yes	No	No	FC6A-EXM1S

Communication Module

Package Quantity: 1

Name	Connectable CPU Module			Terminal	Part No.
	Plus	All-in-One	J1939 All-in-One		
RS232C/RS485 Communication Module	Yes	Yes	Yes	Removable, 3.81mm pitch, 10-pin, screw fastened type connector	FC6A-SIF52

Communication Cartridges

Package Quantity: 1

Name	Connectable CPU Module			Part No.
	Plus	All-in-One	CAN J1939 All-in-One	
RS232C	Yes (*1)	Yes	Yes	FC6A-PC1
RS485	Yes (*1)	Yes	Yes	FC6A-PC3
Bluetooth	Yes (*1)	Yes	Yes	FC6A-PC4

Digital I/O Cartridges

Package Quantity: 1

Name	Connectable CPU Module			I/O Points	Part No.
	Plus	All-in-One	CAN J1939 All-in-One		
Digital Input	Yes (*1)	Yes	Yes	4 inputs	FC6A-PN1
Digital Output	Yes (*1)	Yes	Yes	4 transistor sink outputs	FC6A-PTK4
	Yes (*1)	Yes	Yes	4 transistor source outputs	FC6A-PTS4

Analog I/O Cartridges

Package Quantity: 1

Name	Connectable CPU Module			I/O Points	Part No.
	Plus	All-in-One	CAN J1939 All-in-One		
Analog Voltage/Current Input	Yes (*1)	Yes	Yes	2 inputs	FC6A-PJ2A
Analog Temperature Input					FC6A-PJ2CP
Analog Voltage Output	Yes (*1)	Yes	Yes	2 outputs	FC6A-PK2AV
Analog Current Output					FC6A-PK2AW

Cartridge Base Module

Package Quantity: 1

Name	Connectable CPU Module			Part No.
	Plus	All-in-One	CAN J1939 All-in-One	
Cartridge Base Module	Yes	No	No	FC6A-HPH1

Programming Software

Package Quantity: 1

Name	Part No.
Application Software Automation Organizer Ver. 3.90 or higher WindLDR V.8.6 or higher	SW1A-W1C

*1) When a cartridge base module is added to the left of CPU.

 Download catalogs and CAD from <http://eu.idec.com/downloads>

L-016

FC6A Micro Programmable Logic Controllers

Option

Name	Description	Part No.	Package Quantity	
Plus CPU Module Terminal Block Connector	3.81mm pitch, 10-pin, screw fastened type for FC6A-D16□1CEE	FC6A-PMTCN10PN02	2	
	3.81mm pitch, 11-pin, screw fastened type for FC6A-D16R1CEE	FC6A-PMTCR11PN02		
	3.81mm pitch, 11-pin, screw fastened type for FC6A-D16K1CEE	FC6A-PMTCCK11PN02		
	3.81mm pitch, 11-pin, screw fastened type for FC6A-D16P1CEE	FC6A-PMTCP11PN02		
	3.81mm pitch, 10-pin, spring clamp type for FC6A-D16□1CEE	FC6A-PMSCN10PN02		
	3.81mm pitch, 11-pin, spring clamp type for FC6A-D16R1CEE	FC6A-PMSCR11PN02		
	3.81mm pitch, 11-pin, spring clamp type for FC6A-D16K1CEE	FC6A-PMSCCK11PN02		
	3.81mm pitch, 11-pin, spring clamp type for FC6A-D16P1CEE	FC6A-PMSCP11PN02		
Terminal Block Connector for All-in-One CPU Module/ CAN J1939 All-in-One CPU Module	5.08mm pitch, 8-pin, screw fastened type for FC6A-C24□1□E	FC6A-PMTA08PN02	2	
	5.08mm pitch, 9-pin, screw fastened type all CPU modules	FC6A-PMTA09PN02		
	5.08mm pitch, 10-pin, screw fastened type for FC6A-C40□1□E□	FC6A-PMTA10PN02		
	5.08mm pitch, 12-pin, screw fastened type for FC6A-C16□1□E	FC6A-PMTA12PN02		
	5.08mm pitch, 13-pin, screw fastened type for FC6A-C24□1□E	FC6A-PMTA13PN02		
CAN J1939 All-in-One CAN Communication Terminal Block Connector	5.08mm pitch, 5-pin, screw fastened type	FC6A-PMTE05PN02	2	
Expansion Interface Module Terminal Block Connector	5.08mm pitch, 11-pin, screw fastened type	FC6A-PMTB11PN02		
	5.08mm pitch, 11-pin, spring clamp type	FC6A-PMBS11PN02		
	3.81mm pitch, 10-pin, screw fastened type	FC6A-PMTC10PN02		
	3.81mm pitch, 11-pin, screw fastened type	FC6A-PMTC11PN02		
	3.81mm pitch, 17-pin, screw fastened type	FC6A-PMTC17PN02		
	3.81mm pitch, 10-pin, spring clamp type	FC6A-PMSC10PN02		
	3.81mm pitch, 11-pin, spring clamp type	FC6A-PMSC11PN02		
	3.81mm pitch, 17-pin, spring clamp type	FC6A-PMSC17PN02		
MIL Connector for Plus CPU Module/Expansion Module	20-pin MIL connector	FC4A-PMC20PN02		
FC6A CPU Module Power Supply Terminal Block Connector	5.08mm pitch, 3-pin, screw fastened type	FC6A-PMTD03PN02	5	
Expansion Interface Module Power Supply Terminal Block Connector for FC6A-EXM2/-EXM1S	5.08mm pitch, 3-pin, screw fastened type	FC6A-PMTB03PN02		
CPU Module Connector with Analog Input Cable	Connector: UL1977 compliant, Wire: UL758 style 1007 compliant	FC4A-PMAC2PN02		
CPU Module Battery Holder		FC6A-BH1PN02	10	
CPU Module Mounting Hook	Can be used with HMI module	FC6A-PSP1PN05		
Expansion Module Mounting Hook	Can be used with expansion interface module	FC6A-PSP2PN05		
35-mm-wide DIN Rail	Aluminium, 1m	BAA1000PN10	10	
	Steel, 1m	BAP1000PN10		
End Clip		BNL6PN10	1	
USB Maintenance Cable	2m long, USB-mini B	HG9Z-XCM42		
USB-mini B Port Extension Cable	1m long, USB-mini B	HG9Z-XCE21		
I/O Communication Cable	For connecting HG4G/3G/2G, external device, and general-purpose operator interface to MicroSmart (5m) RJ45 connector: loose wire RJ45 connector: UL1863 compliant Wire: UL758 style 20276 compliant	FC6A-KC1C		
	For connecting HG4G/3G/2G to MicroSmart: D-sub 9-pin (5m) RJ45 connector: D-sub 9-pin connector RJ45 connector: UL1863 compliant Wire: UL758 style 20276 compliant D-sub connector plastic: UL94-V0	FC6A-KC2C		
I/O Terminal Cable	20-pin	Shielded Wire: UL758 style 20266 compliant MIL connector plastic: UL94-V0		0.5m FC9Z-H050A20
				1m FC9Z-H100A20
				2m FC9Z-H200A20
				3m FC9Z-H300A20
		Non-shielded Wire: UL758 style 2651 compliant MIL connector plastic: UL94-V0		0.5m FC9Z-H050B20
			1m FC9Z-H100B20	
	2m FC9Z-H200B20			
	3m FC9Z-H300B20			
Instruction Manual	User's Manual	Japanese	FC9Y-B1721	
		English	FC9Y-B1722	
		Simplified Chinese (PDF)	FC9Y-B1723	
	Ladder Programming	Japanese	FC9Y-B1725	
		English	FC9Y-B1726	
		Simplified Chinese (PDF)	FC9Y-B1727	
	All-in-One Plus Communication	Japanese	FC9Y-B1729	
		English	FC9Y-B1730	
		Simplified Chinese (PDF)	FC9Y-B1731	
	PID Module	Japanese	FC9Y-B1733	
		English	FC9Y-B1734	
		Simplified Chinese (PDF)	FC9Y-B1735	

* MicroSmart User's manual and other manuals applicable to Automation Organizer can be downloaded from <http://www.idec.com/language>.

FC6A Micro Programmable Logic Controllers

Controllers

Plus CPU Modules

Specifications

Part No.	FC6A-D16R1CEE FC6A-D16P1CEE FC6A-D16K1CEE	FC6A-D32P3CEE FC6A-D32K3CEE
Rated Power Voltage	24V DC	
Allowable Voltage Range	20.4 to 28.8V DC (including ripple)	
Maximum Power Consumption (CPU module)	FC6A-D16R1CEE: 2.88W (24V DC) FC6A-D16P1CEE: 2.88W (24V DC) FC6A-D16K1CEE: 2.88W (24V DC) FC6A-D32P3CEE: 3.36W (24V DC) FC6A-D32K3CEE: 3.36W (24V DC)	
Inrush Current	35A maximum	
Allowable Momentary Power Interruption	10 ms (at rated voltage)	
Operating Temperature	-10 to +55°C (no freezing)	
Storage Temperature	-25 to +70°C (no freezing)	
Relative Humidity	Level RH1 (IEC 61131-2) 10 to 95% (no condensation)	
Altitude	Operation: 0 to 2,000m, 1,013 to 795 hPa, Transport: 0 to 3,000m, 1,013 to 701 hPa	
Pollution Degree	2 (IEC 60664-1)	
Corrosion Immunity	Free from corrosive gases	
Dielectric Strength	Between power and FE terminals: 500V AC, 1 minute Between transistor output and FE terminals: 500V AC, 1 minute Between power and input terminals: 500V AC, 1 minute Between power and relay output terminals: 2,300V AC, 1 minute Between input and relay output terminals: 2,300V AC, 1 minute	Between input and FE terminals: 500V AC, 1 minute Between relay output and FE terminals: 2,300V AC, 1 minute Between power and transistor output terminals: 500V AC, 1 minute Between input and transistor output terminals: 500V AC, 1 minute
Insulation Resistance	Between power and FE terminals: 100 MΩ or higher (500V DC megger) Between transistor output and FE terminals: 100MΩ or higher (500V DC megger) Between power and input terminals: 100 MΩ or higher (500V DC megger) Between power and relay output terminals: 100 MΩ or higher (500V DC megger) Between input and relay output terminals: 100 MΩ or higher (500V DC megger)	Between input and FE terminals: 100 MΩ or higher (500V DC megger) Between relay output and FE terminals: 100 MΩ or higher (500V DC megger) Between power and transistor output terminals: 100 MΩ or higher (500V DC megger) Between input and transistor output terminals: 100 MΩ or higher (500V DC megger)
Noise Resistance	AC/DC power terminals: 1kV, 50 ns to 1 μs I/O terminals (coupling clamp): 1.5kV, 50ns to 1μs coupling adapter	
Vibration Resistance	5 to 8.4 Hz amplitude 3.5 mm 8.4 to 150 Hz acceleration 9.8 m/s ² (1G), 2 hours per axis on each of three mutually perpendicular axes (IEC 61131-2)	
Shock Resistance	147 m/s ² (15G), 11 ms duration, 3 shocks per axis on three mutually perpendicular axes	
Degree of Protection	IP20 (IEC 60529)	
Power Supply Wire	UL1007 AWG24-16, UL2464 AWG24-16, UL1015 AWG20-16	
Grounding Wire	UL1007 AWG16	
Ground	D-type ground (Class 3 ground)	
Mounting	DIN rail or panel mounting	
Weight (approx.)	FC6A-D16R1CEE: 290g FC6A-D16P1CEE: 275g FC6A-D16K1CEE: 275g	FC6A-D32P3CEE: 255g FC6A-D32K3CEE: 255g

APEM
Switches & Pilot Lights
Control Boxes
Emergency Stop Switches
Enabling Switches
Safety Products
Explosion Proof
Terminal Blocks
Relays & Sockets
Circuit Protectors
Power Supplies
LED Illumination
Controllers
Operator Interfaces
Sensors
AUTO-ID
FC6A
FT1A
FL1F



Download catalogs and CAD from <http://eu.idec.com/downloads>

L-018

FC6A Micro Programmable Logic Controllers

Controllers

Function Specifications

Note: Limited number of output points can be turned on.

Part No.	FC6A-D16R1CEE FC6A-D16P1CEE (*4) FC6A-D16K1CEE (*4)	FC6A-D32P3CEE (*4) FC6A-D32K3CEE (*4)
Control System	Stored program system	
Instruction Words	Basic	42
	Advanced	130
Program Capacity (*1)	800KB (100,000 steps)	
User Program Download	1,000 times	
Processing Time	Basic Instruction	21µs/1,000 steps
	END Processing (*2)	1ms maximum
I/O Points	Input	8 points
	Output	8 points
Expansion Module	Expandable Modules	7 modules (*3)
	Expandable I/O Points	224 points
Expansion Interface Module	Unibody Type Expandable Modules	8 modules
	Unibody Type Expandable I/O Points	256 points
	Separate Type Expandable Modules (*5)	63 modules (separate type master: 1 module maximum, separate type slave: 10 modules maximum)
	Separate Type Expandable I/O Points (*5)	2,016 points
Internal Relay	15,400 points	
Special Internal Relay	1,600 points	
Shift Register	256 points	
Data Register	60,000 points	
Non-Retentive Data Register	200,000 points	
Special Data Register	900 points	
Counter	512 points	
Timer (1ms, 10ms, 100ms, 1s)	2,000 points	
Clock	Clock accuracy: ±30 sec/month (typical) at 25°C	
RAM Backup	Backup Data	Internal relay, shift register, counter, data register, timer, special data register, special internal relay, clock data
	Battery	Lithium primary battery (BR2032)
	Battery Life	Approx. 4 years
	Replaceability	Possible (*6)
Self-diagnostic Function	Keep data, user program (ROM) CRC check, timer/counter preset value change check, user program syntax check, user program execution check, watchdog timer check, user program download check, power failure, clock error, data link connection check, expansion bus initialization check, system check, SD memory card transfer check, SD memory card access check	
Input Filter	0 ms (without filter), 3 to 15ms (selectable in increments of 1ms) I14, I15, I16, I17: 3ms	
Catch Input/Interrupt Input	Six inputs I0, I1, I3, I4, I6, I7 (Minimum turn on pulse width: 5µs max./Minimum turn off pulse width: 5µs max.)	
High-speed Counter	Maximum Counting Frequency and High-speed Counter Points	Total 6 points Single/two-phase selectable: 100 kHz (single-phase: 6 points, two-phase: 3 points)
	Counting Range	0 to 4,294,967,295 (32 bits)
	Operation Mode	Rotary encoder mode, adding counter mode, frequency measurement mode
Analog Potentiometer	Quantity	1 point
	Data Range	0 to 1,000
Analog Voltage Input	Quantity	1 point
	Input Voltage Range	0 to 10V
	Input Impedance	Approx. 100KΩ
	Digital Resolution	Approx. 4,000 steps (12 bits)
Pulse Output (transistor output model only)	Quantity	4 points
	Maximum Output Pulse Frequency	Q0, Q2, Q4, Q6: 100kHz
	Reversible Control	Single-pulse output mode: 4 axis (Q0-Q7), Dual-pulse output mode: 4 axis (Q0-Q7)
PWM Output	Duty cycle 0.1 to 100.0% (increments of 0.1%), Output pulse frequency 15 to 5,000 Hz (increments of 1 Hz): 4 points (Q0, Q2, Q4, Q6) (Adjust 5µs minimum as ON time and 15µs minimum as OFF time.)	
USB Port	USB mini-B (maintenance communication)	
Ethernet Port 1	Maintenance communication (server), user communication TCP (server/client), user communication UDP, Modbus TCP (server/client), Email, Web Server, PING, SNMP, FTP server/client, BACnet/IP (*7)	
Ethernet Port 2	Maintenance communication (server), user communication TCP (server/client), user communication UDP, Modbus TCP (server/client), PING	
Cartridge (option)	Two cartridges can be added (when using FC6A-HPH1)/One cartridge can be added (when using FC6A-PH1)	
SD Card Slot	Embedded	
HMI Module (option)	Yes	

*1) 1 step equals 8 bytes.

*2) Not including expansion I/O service time, counter timer processing time, data link processing time, and interrupt processing time.

*3) A maximum of 5 modules can be connected when using the expansion interface module separate type master.

*4) Transistor output model

*5) Communication module cannot be connected.

*6) Backup data is stored after power is turned off. Replacing the battery within 1 minute is recommended.

*7) Plus CPU module System software Ver. 1.20 or later. (Included in WindLDR Ver. 8.90 in Automation Organizer Ver. 3.12.0 or later)

L-019

For more information, visit <http://eu.idec.com>

FC6A Micro Programmable Logic Controllers

Controllers

Plus CPU Modules

Specifications

USB Port

Part No.	FC6A-D16R1CEE / FC6A-D16P1CEE / FC6A-D16K1CEE	FC6A-D32P3CEE / FC6A-D32K3CEE
USB Type	USB mini-B	
USB Standard	USB 2.0	
Isolation	Not isolated from the internal circuit	
Communication Function	Maintenance communication to PC	

Ethernet Port 1

Part No.	FC6A-D16R1CEE FC6A-D16P1CEE FC6A-D16K1CEE	FC6A-D32P3CEE FC6A-D32K3CEE
Communication Type	IEEE802.3 compliant	
Communication Speed	10BASE-T, 100BASE-TX	
Connector	RJ45	
Cable	CAT. 5 or higher STP	
Maximum Cable Length	100m	
Isolation	Pulse trans isolation	
Communication Function	Maintenance communication (server), user communication (server/client), user communication UDP, Modbus TCP (server/client), Email, Web Server, PING, SNMP, FTP server/client, BACnet/IP	

Ethernet Port 2

Part No.	FC6A-D16R1CEE FC6A-D16P1CEE FC6A-D16K1CEE	FC6A-D32P3CEE FC6A-D32K3CEE
Communication Type	IEEE802.3 compliant	
Communication Speed	10BASE-T, 100BASE-TX	
Connector	RJ45	
Cable	CAT. 5 or higher STP	
Maximum Cable Length	100m	
Isolation	Pulse trans isolation	
Communication Function	Maintenance communication (server), user communication (server/client), user communication UDP, Modbus TCP (server/client), PING	

BACnet/IP

Part No.	FC6A-D16R1CEE / FC6A-D16P1CEE / FC6A-D16K1CEE	FC6A-D32P3CEE / FC6A-D32K3CEE
Supported Port	Ethernet Port 1	
Applicable Standards	ANSI/ASHRAE135-2012	
Standard Specifications	Protocol	BACnet/IP
	Profile	B-ASC
	Object Type	Device Object, Analog Input Object, Analog Output Object, Analog Value Object, Binary Input Object, Binary Output Object, Binary Value Object
	Number of Objects	256 maximum (*1)
	BIBBs	DS-RP-B, DS-WP-B, DS-RPM-B, DS-WPM-B, DS-COV-B, DS-COVU-B, DM-DDB-B, DM-DOB-B, DM-DCC-B
	BBMD	None-BBMD Device
	Virtual Device	No
Foreign Device	Yes	
Subscribed COV Function	Number of Requests That Can Be Accepted	256 requests maximum
Unsubscribed COV Function	Transmission Unit	Every object
	Transmission Cycle	1 to 65,535 [ms] (*2)
Foreign Device Function	Registration Method	Registration as needed by registration trigger device
	Lifetime	0 to 65,535 [s]
Device Binding Function	<ul style="list-style-type: none"> Synchronization between properties and devices (*3) Data type conversion of Present_Value (*4) Coefficient conversion of Present_Value (*4) 	

*1) Device Object is not included. *2) The transmission cycle is set for all objects. *3) The properties of objects created in internal memory are synchronized with specified devices. *4) Supported objects are Analog Input Object, Analog Output Object, and Analog Value Object.

Input

Part No.	FC6A-D16R1CEE / FC6A-D16P1CEE / FC6A-D16K1CEE	FC6A-D32P3CEE / FC6A-D32K3CEE
Input Points	8 (8/1 common)	16 (16/1 common)
Rated Input Voltage	24V DC: 24V DC sink/source input signal	
Input Voltage Range	0 to 28.8V DC	
Rated Input Current	High speed input port 5mA/pt, middle/normal speed input port 7mA/pt	
Input Impedance	High speed input port 4.9kΩ, middle/normal speed input port: 3.4kΩ	
Input Delay	Turn ON Time	High speed input port: 5μs + filter value Middle speed input port: 35μs + filter value Normal speed input port: 35μs + filter value
	Turn OFF Time	High speed input port: 5us + filter value Middle speed input port: 35us + filter value Normal speed input port: 100us + filter value
Isolation	Between input terminals: Not isolated Internal circuit: Optocoupler-isolated	
Input Type	Type1 (IEC 61131-2)	
External Load for I/O Interconnection	Not needed	
Signal Determination Method	Static	
Effect of Improper Input Connection	Both sinking and sourcing input signals can be connected, therefore reverse connection does not cause damage. If any input exceeding the rated value is applied, permanent damage may be caused.	
Cable Length	3m in compliance with electromagnetic immunity	
Connector	Type (on mother board)	—
	Insertion Durability	100 times minimum
	Applicable Ferrule	1-wire: AI 0.5-8 WH (Phoenix Contact) 2-wire: AI-TWIN 2×0.5-8 WH (Phoenix Contact)

Download catalogs and CAD from <http://eu.idec.com/downloads>

APEM
Switches & Pilot Lights
Control Boxes
Emergency Stop Switches
Enabling Switches
Safety Products
Explosion Proof
Terminal Blocks
Relays & Sockets
Circuit Protectors
Power Supplies
LED Illumination

Controllers

Operator Interfaces

Sensors

AUTO-ID

FC6A

FT1A

FL1F

L-020

FC6A Micro Programmable Logic Controllers

Relay Output

Part No.		FC6A-D16R1CEE
Relay Output Points		8
Output Points per Common Line	COM1	4
	COM2	4
Output Type		1NO
Maximum Load Current	Per Point	2A
	Per Common	COM1: 7A COM2: 7A
Minimum Switching Load		1mA/5V DC (reference value)
Initial Contact Resistance		30 mΩ maximum
Electrical Life		100,000 operations minimum (rated resistive load 1,800 operations/hour)
Mechanical Life		20,000,000 operations minimum (no load 18,000 operations/hour)
Rated Load		Resistive load: 240V AC 2A, 30V DC 2A Inductive load: 240V AC 2A (cos φ = 0.4), 30V DC 2A (L/R = 7 ms)
Connector	Insertion/Removal Durability	100 times minimum
	Applicable Ferrule	1-wire: AI 0,5-8 WH (Phoenix Contact) 2-wire: AI-TWIN 2×0,5-8 WH (Phoenix Contact)

Transistor Output

Part No.		FC6A-C16P1CEE FC6A-C16K1CEE	FC6A-D32P3CEE FC6A-D32K3CEE
Transistor Output Points		8 (8/1 common)	16 (16/1 common)
Output Type	Transistor Sink	FC6A-D16K1CEE/FC6A-D32K3CEE	
	Transistor Source	FC6A-D16P1CEE/FC6A-D32P3CEE	
Rated Load Voltage		24V DC	
Voltage Tolerance		19.2 to 28.8V DC	
Rated Load Current	Per Point	0.5A	0.1A
	Per Common	4.0A	1.6A
Output Delay	Turn ON Time	High speed input port: 5µs Normal speed input port: 300µs	
	Turn OFF Time	High speed input port: 5µs Normal speed input port: 300µs	
Isolation		Between output terminal and Internal circuit: Optocoupler-isolated Between output terminals: Not isolated	
Voltage Drop (ON Voltage)		1V max (voltage between COM and output terminal when output is on.)	
Inrush Current		1A	0.2A
Leakage Current		0.1mA maximum	
Clamping Voltage		39V ±1V	
Maximum Lamp Load		12W	2.4W
Inductive Load		L/R=10ms (28.8V DC, 1Hz)	
Overcurrent Protection		Transistor Sink Output: No Transistor Source Output: Overcurrent is detected by current limit resistance. (*1)	
External Current Draw		100mA maximum, 24V DC (power voltage at the +V terminal, -V terminal at source)	
Connector	Type (on mother board)	—	FL20A2MA (Oki Electric Cable)
	Insertion Durability	100 times minimum	
Connector	Applicable Ferrule	1-wire: AI 0,5-8 WH (Phoenix Contact) 2-wire: AI-TWIN 2×0,5-8 WH (Phoenix Contact)	—

*1) This overcurrent signals consist of one signal per 4 point outputs. When microprocessor gets this overcurrent signal by interrupt input, microprocessor turns off 4pt outputs of this category at fixed time (approx. 1sec).

FC6A Micro Programmable Logic Controllers

Controllers

All-in-One/CAN J1939 All-in-One CPU Modules

Specifications

Part No.	FC6A-C16R1AE FC6A-C16R1CE FC6A-C16P1CE FC6A-C16K1CE	FC6A-C24R1AE FC6A-C24R1CE FC6A-C24P1CE FC6A-C24K1CE	FC6A-C40R1AE FC6A-C40R1CE FC6A-C40P1CE FC6A-C40K1CE FC6A-C40R1DE FC6A-C40P1DE FC6A-C40K1DE	FC6A-C40R1AEJ FC6A-C40R1CEJ FC6A-C40P1CEJ FC6A-C40K1CEJ FC6A-C40R1DEJ FC6A-C40P1DEJ FC6A-C40K1DEJ
Rated Power Voltage	AC: 100 to 240V AC, DC: 24V DC, 12V DC			
Allowable Voltage Range	AC: 85 to 264V AC 24V DC: 20.4 to 28.8V DC (including ripple), 12V DC: 10.2 to 18.0V			
Rated Frequency	AC: 50/60Hz (47 to 63 Hz)			
Maximum Power Consumption (CPU module)	AC	FC6A-C16R1AE: 100-240V AC, 33VA FC6A-C24R1AE: 100-240V AC, 35VA	FC6A-C40R1AE: 100-240V AC, 41VA FC6A-C40R1AEJ: 100-240V AC, 37VA	
	DC	FC6A-C16R1CE: 24V DC 140mA, 3.36W FC6A-C24R1CE: 24V DC 155mA, 3.72W FC6A-C40R1CE: 24V DC 195mA, 4.68W FC6A-C16P1CE: 24V DC 190mA, 4.6W FC6A-C24P1CE: 24V DC 200mA, 4.8W FC6A-C40P1CE: 24V DC 205mA, 5.0W FC6A-C16K1CE: 24V DC 190mA, 4.6W FC6A-C24K1CE: 24V DC 200mA, 4.8W	FC6A-C40K1CE: 24V DC 205mA, 5.0W FC6A-C40R1DE: 12V DC 345mA, 4.14W FC6A-C40P1DE: 12V DC 260mA, 3.12W FC6A-C40K1DE: 12V DC 260mA, 3.12W FC6A-C40R1CEJ: 24V DC 205mA, 5.0W FC6A-C40P1CEJ: 24V DC 175mA, 4.2W FC6A-C40K1CEJ: 24V DC 175mA, 4.2W FC6A-C40R1DEJ: 12V DC 340mA, 4.08W FC6A-C40P1DEJ: 12V DC 320mA, 3.9W FC6A-C40K1DEJ: 12V DC 320mA, 3.9W	
Inrush Current	AC: 40A maximum 24V DC: 35A maximum 12V DC: 35A maximum			
Allowable Momentary Power Interruption	10 ms (at rated voltage)			
Operating Temperature	-10 to +55°C (no freezing)			
Storage Temperature	-25 to +70°C (no freezing)			
Relative Humidity	Level RH1 (IEC 61131-2:10 to 95% (no condensation))			
Altitude	Operation: 0 to 2,000m, 1,013 to 795 hPa, Transport: 0 to 3,000m, 1,013 to 701 hPa			
Pollution Degree	2 (IEC 60664-1)			
Corrosion Immunity	Free from corrosive gases			
Dielectric Strength	AC	Between power and PE terminals: 1,500V AC, 1 minute Between relay output and PE terminals: 2,300V AC, 1 minute Between power and relay output terminals: 2,300V AC, 1 minute	Between input and PE terminals: 1,500V AC, 1 minute Between power and input terminals: 1,500V AC, 1 minute Between input and relay output terminals: 2,300V AC, 1 minute	
	DC	Between power and FE terminals: 500V AC, 1 minute Between transistor output and FE terminals: 500V AC, 1 minute Between power and input terminals: 500V AC, 1 minute Between power and relay output terminals: 2,300V AC, 1 minute Between input and relay output terminals: 2,300V AC, 1 minute	Between input and FE terminals: 500V AC, 1 minute Between relay output and FE terminals: 2,300V AC, 1 minute Between power and transistor output terminals: 500V AC, 1 minute Between input and transistor output terminals: 500V AC, 1 minute	
Insulation Resistance	AC	Between power and PE terminals: 100 MΩ or higher (500V DC megger) Between relay output and PE terminals: 100 MΩ or higher (500V DC megger) Between power and relay output terminals: 100 MΩ or higher (500V DC megger)	Between input and PE terminals: 100 MΩ or higher (500V DC megger) Between power and input terminals: 100 MΩ or higher (500V DC megger) Between input and relay output terminals: 100 MΩ or higher (500V DC megger)	
	DC	Between power and FE terminals: 100 MΩ or higher (500V DC megger) Between transistor output and FE terminals: 100 MΩ or higher (500V DC megger) Between power and input terminals: 100 MΩ or higher (500V DC megger) Between power and relay output terminals: 100 MΩ or higher (500V DC megger) Between input and relay output terminals: 100 MΩ or higher (500V DC megger)	Between input and FE terminals: 100 MΩ or higher (500V DC megger) Between relay output and PE terminals: 100 MΩ or higher (500V DC megger) Between power and transistor output terminals: 100 MΩ or higher (500V DC megger) Between input and transistor output terminals: 100 MΩ or higher (500V DC megger)	
Noise Resistance	AC or DC power terminal: 1.5kV (DC type: 1kV), 50 ns to 1 μs I/O terminals (coupling clamp): 1.5kV, 50ns to 1μs coupling adapter			
Vibration Resistance	5 to 8.4 Hz amplitude 3.5 mm, 8.4 to 150 Hz acceleration 9.8 m/s ² (1G), 2 hours per axis on each of three mutually perpendicular axes (IEC 61131-2)			
Shock Resistance	147 m/s ² (15G), 11 ms duration, 3 shocks per axis on three mutually perpendicular axes			
Degree of Protection	IP20 (IEC 60529)			
Power Supply Wire	UL1007 AWG24-16, UL2464 AWG24-16, UL1015 AWG20-16			
Grounding Wire	AWG16			
Ground	D-type ground (Class 3 ground)			
Mounting	DIN rail or panel mounting			
Weight	AC: 350g DC: 340g	AC: 420g DC: 400g	AC: 560g DC (relay): 530g DC (transistor): 480g	AC: 560g DC (relay/24V DC): 530g DC (relay/12V DC): 560g DC (transistor/24V DC): 480g DC (transistor/12V DC): 530g

APEM
Switches & Pilot Lights
Control Boxes
Emergency Stop Switches
Enabling Switches
Safety Products
Explosion Proof
Terminal Blocks
Relays & Sockets
Circuit Protectors
Power Supplies

LED Illumination
Controllers
Operator Interfaces
Sensors
AUTO-ID

FC6A
FT1A
FL1F



Download catalogs and CAD from <http://eu.idec.com/downloads>

L-022

FC6A Micro Programmable Logic Controllers

Controllers

Function Specifications

Note: The maximum number of relay outputs that can be turned on simultaneously is limited.

Part No.	FC6A-C16R1AE FC6A-C16R1CE FC6A-C16P1CE (*5) FC6A-C16K1CE (*5)	FC6A-C24R1AE FC6A-C24R1CE FC6A-C24P1CE (*5) FC6A-C24K1CE (*5)	FC6A-C40R1AE FC6A-C40R1CE FC6A-C40P1CE (*5) FC6A-C40K1CE (*5) FC6A-C40R1DE FC6A-C40P1DE (*5) FC6A-C40K1DE (*5)	FC6A-C40R1AEJ FC6A-C40R1CEJ FC6A-C40P1CEJ (*5) FC6A-C40K1CEJ (*5) FC6A-C40R1DEJ FC6A-C40P1DEJ (*5) FC6A-C40K1DEJ (*5)
APEM	Control System			
Switches & Pilot Lights	Instruction Words		Stored program system	
	Basic		42	
Control Boxes	Advanced		129	
	Program Capacity (*1)		384KB (48,000 steps)/72KB (9,000 steps) (*2)	
Emergency Stop Switches	User Program Download		1,000 times	
Enabling Switches	Processing Time		42µs/1,000 steps	
	Basic Instruction		1ms maximum	
Safety Products	END Processing (*3)		1ms maximum	
	I/O Points		9 points	
Explosion Proof	Input		14 points	
	Output		24 points	
Terminal Blocks	Expandable Modules		4 modules	
	Expandable I/O Points with Expansion Modules		7 modules	
Relays & Sockets	Expandable Modules with Unibody Type		7 modules	
	Expansion Interface Modules		16 points	
Circuit Protectors	Expandable I/O Points with Expansion Interface Modules		256 points	
	Internal Relay		12,400 points	
Power Supplies	Special Internal Relay		256 points	
	Shift Register		256 points	
LED Illumination	Data Register		54,000 points	
	Special Data Register		500 points	
Controllers	Counter		512 points	
	Timer (1ms, 10ms, 100ms, 1s)		1,024 points	
Operator Interfaces	Clock		Clock accuracy: ±30 sec/month (typical) at 25°C	
	Backup Data		Internal relay, shift register, counter, data register, timer, special data register, special internal relay, clock data	
Sensors	Battery		Lithium primary battery (BR2032)	
	Battery Life		Approx. 4 years	
AUTO-ID	Replaceability		Possible (*6)	
	Self-diagnostic Function		Keep data, user program (ROM) CRC check, timer/counter preset value change check, user program syntax check, user program execution check, watchdog timer check, user program download check, power failure, clock error, data link connection check, expansion bus initialization check, system check, SD memory card transfer check, SD memory card access check	
FC6A	Input Filter		0 ms (without filter), 3 to 15ms (selectable in increments of 1ms)	
	Catch Input/Interrupt Input		Six inputs I0, I1, I6, I7 (Minimum turn on pulse width: 5µs max., Minimum turn off pulse width: 5µs max.) I3, I4 (Minimum turn on pulse width: 35µs max., Minimum turn off pulse width: 35µs max.)	
FT1A	High-speed Counter		Total 6 points Single/two-phase selectable: 100 kHz (single-phase: 4 points, two-phase: 2 points) Single-phase: 5 kHz (2 points)	
	Counting Range		0 to 4,294,967,295 (32 bits)	
FL1F	Operation Mode		Rotary encoder mode, adding counter mode, frequency measurement mode	
	Analog Potentiometer		Quantity: 1 point Data Range: 0 to 1,000	
Analog Voltage Input	Quantity		1 point	
	Input Voltage Range		0 to 10V	
Pulse Output (transistor output model only)	Input Impedance		Approx. 100KΩ	
	Digital Resolution		Approx. 1,000 steps (10 bits)	
External Power Supply for Sensor (AC only)	Quantity		4 points	
	Maximum Output Pulse Frequency		Q0, Q1: 100 kHz Q2, Q3: 5 kHz	
USB Port	Reversible Control		Single-pulse output mode: 2 axis (Q0-Q3) Dual-pulse output mode: 1 axis (Q0-Q1)	
	Pulse Output		Duty cycle 0.1 to 100.0% (increments of 0.1%) Output pulse frequency 15 to 5,000 (increments of 1 Hz): 4 points (Q0-Q3) *Q0, Q1: Adjust 5µs minimum as ON time and 15µs minimum as OFF time. *Q2, Q3: Adjust 100µs minimum as ON/OFF time.	
Serial Port 1, CAN Port	Output Voltage/Current		24V (+10%, -15%) / 250mA	
	Overload Detection		Not possible	
Ethernet Port 1	Isolation from the internal circuit		Transformer-isolated	
	USB Port		USB mini-B (maintenance communication)	
SD Card Slot	Serial Port 1, CAN Port		RS232C or RS485 (*4)	
	Ethernet Port 1		Ethernet (maintenance communication, user communication, Modbus TCP server/client)	
Cartridge (option)	SD Card Slot		Embedded (*7)	
	Cartridge (option)		One cartridge can be added on CPU module One cartridge can be added on HMI module (FC6A-PH1)	
HMI Module (option)	HMI Module (option)		Two cartridges can be added on CPU module One cartridge can be added on HMI module (FC6A-PH1)	
	HMI Module (option)		Yes	

*1) 1 step equals 8 bytes.
*2) When 72KB is selected, download function can be used during RUN.
*3) Not including expansion I/O service time, counter timer processing time, data link processing time, and interrupt processing time.

*4) Maintenance communication, user communication, data link, Modbus RTU master/slave communication.
*5) Transistor output model
*6) Backup data is stored after power is turned off. Replacing the battery within 1 minute is recommended.
*7) SD memory cards (max 2 GB), SDHC memory cards (max 32 GB)

L-023

For more information, visit <http://eu.idec.com>

FC6A Micro Programmable Logic Controllers

Controllers

All-in-One/CAN J1939 All-in-One CPU Modules

Specifications

USB Port

Part No.	FC6A-C16R1AE FC6A-C16R1CE FC6A-C16P1CE FC6A-C16K1CE	FC6A-C24R1AE FC6A-C24R1CE FC6A-C24P1CE FC6A-C24K1CE	FC6A-C40R1AE FC6A-C40R1CE FC6A-C40P1CE FC6A-C40K1CE FC6A-C40R1DE FC6A-C40P1DE FC6A-C40K1DE	FC6A-C40R1AEJ FC6A-C40R1CEJ FC6A-C40P1CEJ FC6A-C40K1CEJ FC6A-C40R1DEJ FC6A-C40P1DEJ FC6A-C40K1DEJ
USB Type	USB mini-B			
USB Standard	USB 2.0 full speed			
Isolation	Not isolated from the internal circuit			
Communication Function	Maintenance communication to PC			

Serial Port 1, CAN Port

Part No.	FC6A-C16R1AE FC6A-C16R1CE FC6A-C16P1CE FC6A-C16K1CE	FC6A-C24R1AE FC6A-C24R1CE FC6A-C24P1CE FC6A-C24K1CE	FC6A-C40R1AE FC6A-C40R1CE FC6A-C40P1CE FC6A-C40K1CE FC6A-C40R1DE FC6A-C40P1DE FC6A-C40K1DE	FC6A-C40R1AEJ FC6A-C40R1CEJ FC6A-C40P1CEJ FC6A-C40K1CEJ FC6A-C40R1DEJ FC6A-C40P1DEJ FC6A-C40K1DEJ
Port Type	Serial port 1			CAN port
Communication Type	RS232C or RS485 selectable			CAN
Connector	RJ45			Terminal Block (5-pin)
Cable	CAT. 5 or higher STP			SAE J1939-11/SAE J1939-15
Maximum Baud Rate	115,200 bps			SAE J1939-11: 250 kbps: 40m, stubs, 1m maximum
Maximum Cable Length	RS232C: 5m, RS485: 200m			SAE J1939-15: 250 kbps: 40m, stubs, 3m maximum
Isolation	Not isolated from the internal circuit			Isolated from the internal circuit
Communication Function	Maintenance communication, user communication, Modbus RTU (master/slave)			J1939

Ethernet Port 1

Part No.	FC6A-C16R1AE FC6A-C16R1CE FC6A-C16P1CE FC6A-C16K1CE	FC6A-C24R1AE FC6A-C24R1CE FC6A-C24P1CE FC6A-C24K1CE	FC6A-C40R1AE FC6A-C40R1CE FC6A-C40P1CE FC6A-C40K1CE FC6A-C40R1DE FC6A-C40P1DE FC6A-C40K1DE	FC6A-C40R1AEJ FC6A-C40R1CEJ FC6A-C40P1CEJ FC6A-C40K1CEJ FC6A-C40R1DEJ FC6A-C40P1DEJ FC6A-C40K1DEJ
Communication Type	IEEE802.3 compliant			
Data Transfer	10BASE-T, 100BASE-TX			
Connector	RJ45			
Cable	CAT. 5 or higher STP			
Maximum Cable Length	100m			
Isolation	Pulse trans isolation			
Communication Function	Maintenance communication server, User communication (server/client), Modbus TCP (server/client), PING, SNTF			

CAN J1939

Part No.	FC6A-C40P1CEJ FC6A-C40P1DEJ	FC6A-C40K1CEJ FC6A-C40K1DEJ	FC6A-C40R1AEJ FC6A-C40R1DEJ	FC6A-C40R1CEJ
Supported SAE J1939	SAE J1939-11: Physical Layer, 250K bits/s, Twisted Shielded Pair SAE J1939-15: Reduced Physical Layer, 250K bits/s, Unshielded Twisted Pair SAE J1939-21: Data Link Layer		SAE J1939-71: Vehicle Application Layer SAE J1939-73: Application Layer - Diagnostics SAE J1939-75: Application Layer - Generator Sets and Industrial SAE J1939-81: Network Management	
Transmit/Receive Message	Maximum No. of Send Message	100		
	Maximum No. of Receive Message	200		
Transmittable PGN	Transmittable PGN	Optional		
	Maximum Length of Transmit/Receive Message	1 to 252 bytes/message		
Transmission Function	Transmission Type	Event transmission/periodical transmission		
	Event Transmission	Transmission Method	Internal relay	
		Cycle Transmission	Transmission Method	Internal relay
Transmission Cycle (*1)	10 to 655,350 ms (in increments of 10ms)			
Receive Function	Receive Method	Polling reception (*2)		
	Receive Cycle Monitor	0, 10 to 655,350 ms (disabled at 0)		
Request Function	Yes			
Network Management Function	Static address/dynamic address management			
	NAME	Optional (automatic switching of static address /dynamic address management at highest-order bit)		
	Number of Nodes Manageable	128 nodes		
PGNs used Internally	00EA00h: Request PGN			
	00E800h: Acknowledgement			
	00EB00h: TP.DT			
	00EC00h: TP.CM			
00EE00h: Address claim				

*1) Message is transmitted in END processing. Actual transmission cycle is affected by the ladder execution cycle.
*2) Receive message is transferred from internal buffer to data register in END processing.



Download catalogs and CAD from <http://eu.idec.com/downloads>

L-024

FC6A Micro Programmable Logic Controllers

Input

Part No.	FC6A-C16R1AE FC6A-C16R1CE FC6A-C16P1CE FC6A-C16K1CE	FC6A-C24R1AE FC6A-C24R1CE FC6A-C24P1CE FC6A-C24K1CE	FC6A-C40R1AE FC6A-C40R1CE FC6A-C40P1CE FC6A-C40K1CE FC6A-C40R1DE FC6A-C40P1DE FC6A-C40K1DE	FC6A-C40R1AEJ FC6A-C40R1CEJ FC6A-C40P1CEJ FC6A-C40K1CEJ FC6A-C40R1DEJ FC6A-C40P1DEJ FC6A-C40K1DEJ	
APEM	Input Points		9 (9/1 common)	14 (14/1 common)	24 (24/1 common)
Switches & Pilot Lights	Rated Input Voltage		AC, 24V DC: 24V DC sink/source input signal 12V DC: 12V DC sink/source input signal		
Control Boxes	Input Voltage Range		AC, 24V DC: 0 to 28.8V DC 12V DC: 0 to 18.0V DC		
Emergency Stop Switches	Rated Input Current		AC, 24V DC: high speed input port 5mA/pt, middle/normal speed input port 7mA/pt 12V DC: high speed input port 5mA/pt, middle/normal speed input port 6mA/pt		
Enabling Switches	Input Impedance		AC, 24V DC: high speed input port 4.9kΩ, middle/normal speed input port: 3.4kΩ 12V DC: high speed input port 1.8kΩ, middle/normal speed input port: 2.0kΩ		
Safety Products	Input Delay	Turn ON Time	High speed input port: 5μs + filter value Middle speed input port: 35μs + filter value Normal speed input port: 35μs + filter value		
Explosion Proof		Turn OFF Time	High speed input port: 5μs + filter value Middle speed input port: 35μs + filter value Normal speed input port: 100μs + filter value		
Terminal Blocks	Isolation		Between input terminals: Not isolated Internal circuit: Optocoupler-isolated		
Relays & Sockets	Input Type		Type1 (IEC 61131-2)		
Circuit Protectors	External Load for I/O Interconnection		Not needed		
Power Supplies	Signal Determination Method		Static		
LED Illumination	Effect of Improper Input Connection		Both sinking and sourcing input signals can be connected, therefore reverse connection does not cause damage. If any input exceeding the rated value is applied, permanent damage may be caused.		
Controllers	Cable Length		3m in compliance with electromagnetic immunity		
Operator Interfaces	Connector	Insertion Durability	100 times minimum		
Sensors		Applicable Ferrule	1-wire: AI 0,5-8 WH (Phoenix Contact) 2-wire: AI-TWIN 2x0,5-8 WH (Phoenix Contact)		

Transistor Output

Part No.	FC6A-C16P1CE FC6A-C16K1CE	FC6A-C24P1CE FC6A-C24K1CE	FC6A-C40P1CE FC6A-C40K1CE FC6A-C40P1DE FC6A-C40K1DE	FC6A-C40P1CEJ FC6A-C40K1CEJ FC6A-C40P1DEJ FC6A-C40K1DEJ	
AUTO-ID	Transistor Output Points		7 (7/1 common)	10 (10/1 common)	16 (8/1 common)
FC6A	Output Type	Transistor Sink	FC6A-C16K1CE/FC6A-C24K1CE/FC6A-C40K1CE/FC6A-C40K1DE/FC6A-C40K1CEJ/FC6A-C40K1DEJ		
FT1A		Transistor Source	FC6A-C16P1CE/FC6A-C24P1CE/FC6A-C40P1CE/FC6A-C40P1DE/FC6A-C40P1CEJ/FC6A-C40P1DEJ		
FL1F	Rated Load Voltage		24V DC: 24V DC 12V DC: 12V DC		
	Voltage Tolerance		24V DC: 19.2 to 28.8V DC 12V DC: 10.2 to 18.0V DC		24V DC: 19.2 to 28.8V DC 12V DC: 10.2 to 16.0V DC
	Rated Load Current	Per Point	0.5A		
		Per Common	3.5A	5A	4A
	Output Delay	Turn ON Time	High speed input port: 5μs Middle speed input port: 30μs Normal speed input port: 300μs		High speed input port: 5μs Normal speed input port: 300μs
		Turn OFF Time	High speed input port: 5μs Middle speed input port: 30μs Normal speed input port: 300μs		High speed input port: 5μs Normal speed input port: 300μs
	Isolation		Between output terminal and Internal circuit: Optocoupler-isolated Between output terminals: Not isolated		
	Voltage Drop (ON Voltage)		1V max (voltage between COM and output terminal when output is on.)		
	Inrush Current		1A		
	Leakage Current		0.1mA maximum		
	Clamping Voltage		24V DC: 39V ±1V 12V DC: 27V ±1V		
	Maximum Lamp Load		12W		
	Inductive Load		24V DC: L/R=10ms (28.8V DC, 1Hz) 12V DC: FC6A-C40P1DE/FC6A-C40K1DE, L/R=10ms (18.0V DC 1Hz), FC6A-C40P1DEJ/FC6A-C40K1DEJ, L/R=10ms (16.0V DC, 1Hz)		
	Overcurrent Protection		Transistor Sink Output: No Transistor Source Output: Overcurrent is detected by current limit resistance. (*1)		
	External Current Draw		24V DC: 100mA maximum, 24V DC (power voltage at the +V terminal, -V terminal at source) 12V DC: 100mA maximum, 12V DC (power voltage at the +V terminal, -V terminal at source)		
	Connector	Insertion Durability	100 times minimum		
		Applicable Ferrule	1-wire: AI 0,5-8 WH (Phoenix Contact) 2-wire: AI-TWIN 2x0,5-8 WH (Phoenix Contact)		

*1) This overcurrent signals consist of one signal per 4 point outputs. When microprocessor gets this overcurrent signal by interrupt input, microprocessor turns off 4pt outputs of this category at fixed time (approx. 1sec).

FC6A Micro Programmable Logic Controllers

Controllers

All-in-One/CAN J1939 All-in-One CPU Modules

Relay Output Specifications

Part No.	FC6A-C16R1AE FC6A-C16R1CE		FC6A-C24R1AE FC6A-C24R1CE		FC6A-C40R1AE FC6A-C40R1CE FC6A-C40R1DE		FC6A-C40R1AEJ FC6A-C40R1CEJ FC6A-C40R1DEJ		
Relay Output Points	7		10		16				
Output Points per Common Line	COM1	4	4		4				
	COM2	3	4		4				
	COM3	—	2		4				
	COM4	—	—		4				
Output Type	1NO								
Maximum Load Current	Per Point	2A							
	Per Common	COM1: 7A COM2: 6A	COM1: 7A COM2: 7A COM3: 4A		COM1: 7A COM2: 7A COM3: 7A COM4: 7A				
Minimum Switching Load	1mA/5V DC (reference value)								
Initial Contact Resistance	30 mΩ maximum								
Electrical Life	100,000 operations minimum (rated resistive load 1,800 operations/hour)								
Mechanical Life	20,000,000 operations minimum (no load 18,000 operations/hour)								
Rated Load	Resistive load: 240V AC 2A, 30V DC 2A Inductive load: 240V AC 2A (cos φ = 0.4), 30V DC 2A (L/R = 7 ms)								
Dielectric Strength	Between output and ground terminals: 1,500V AC, 1 minute Between output terminal and internal circuit: 1,500V AC, 1 minute Between output terminals (COMs): 1,500V AC, 1 minute								
Connector	Insertion/Removal Durability	100 times minimum							
	Applicable Ferrule	1-wire: AI 0,5-8 WH (Phoenix Contact) 2-wire: AI-TWIN 2×0,5-8 WH (Phoenix Contact)							

- APEM
- Switches & Pilot Lights
- Control Boxes
- Emergency Stop Switches
- Enabling Switches
- Safety Products
- Explosion Proof
- Terminal Blocks
- Relays & Sockets
- Circuit Protectors
- Power Supplies
- LED Illumination
- Controllers
- Operator Interfaces
- Sensors
- AUTO-ID

Temperature derating curves: Input voltage vs. I/O Simultaneous ON Ratio (%)

Plus CPU Module

Input

- FC6A-D16P1CEE
- FC6A-D16K1CEE
- FC6A-D32P3CEE
- FC6A-D32K3CEE

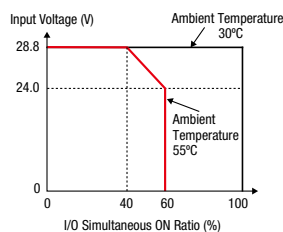

Output

- FC6A-D16P1CEE
- FC6A-D16K1CEE
- FC6A-D32P3CEE
- FC6A-D32K3CEE

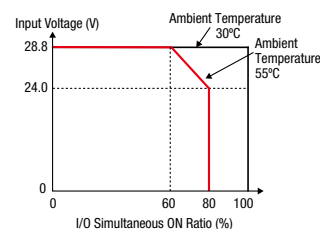

All-in-One/CAN J1936 All-in-One CPU Module (without cartridge)

Input

- FC6A-C24P1CE
- FC6A-C40P1CE
- FC6A-C40P1DE
- FC6A-C40P1CEJ
- FC6A-C40P1DEJ

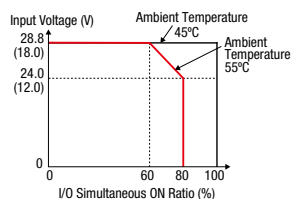

Output

- FC6A-C24P1CE
- FC6A-C40P1CE
- FC6A-C40P1DE
- FC6A-C40P1CEJ
- FC6A-C40P1DEJ

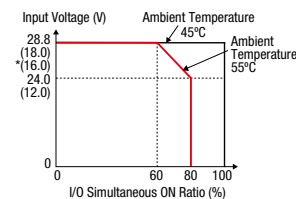

Notes

- Values in () are for 12V DC model.
- Values shown in *() are for CAN J1939 All-in-One CPU module.

Download catalogs and CAD from <http://eu.idec.com/downloads>

L-026

FC6A Micro Programmable Logic Controllers

All-in-One/CAN J1939 All-in-One CPU Module (with cartridge)

Input

FC6A-C24P1CE
FC6A-C40P1CE
FC6A-C40P1DE
FC6A-C40P1CEJ
FC6A-C40P1DEJ

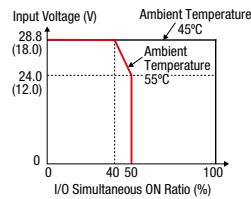

Output

FC6A-C24P1CE
FC6A-C40P1CE
FC6A-C40P1DE
FC6A-C40P1CEJ
FC6A-C40P1DEJ

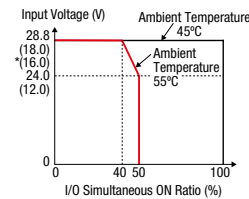

Input

FC6A-C16K1CE
FC6A-C24K1CE
FC6A-C40K1CE
FC6A-C40K1DE
FC6A-C40K1CEJ
FC6A-C40K1DEJ

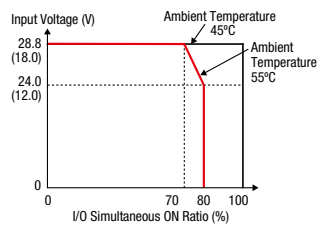

Output

FC6A-C16K1CE
FC6A-C24K1CE
FC6A-C40K1CE
FC6A-C40K1DE
FC6A-C40K1CEJ
FC6A-C40K1DEJ

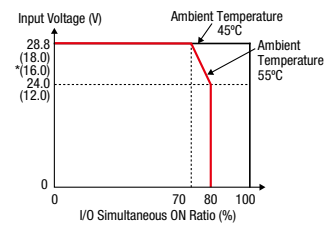

Notes

- Values in () are for 12V DC model.
- Values shown in * () are for CAN J1939 All-in-One CPU module.

Controllers

Operator Interfaces

Sensors

AUTO-ID

Input Internal Circuit

100V to 240V AC, 24V DC

I0, I1, I3, I4, I6, I7 (Plus) I0, I1, I6, I7 (All-in-One)

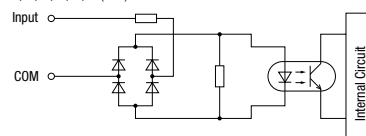

12V DC

I0, I1, I6, I7

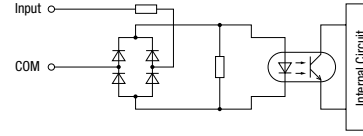

I2, I5, I10 to I17 (Plus) I2 to I5, I10 to I27 (All-in-One)

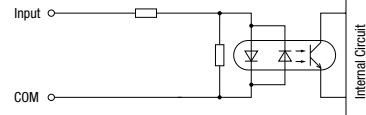

I2 to I5, I10 to I27

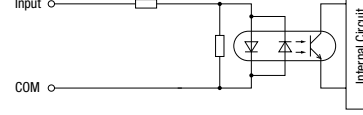

Output Internal Circuit

Transistor Sink Output

24V DC

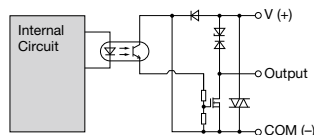

12V DC

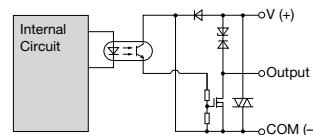

Transistor Source Output

24V DC

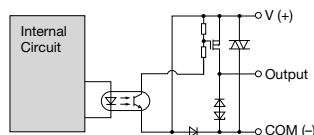

12V DC

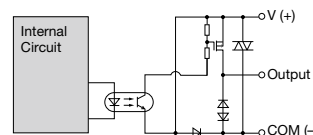

FC6A Micro Programmable Logic Controllers

Controllers

Digital I/O Modules

Specifications

Digital Input Module

Part No.	FC6A-N08B1	FC6A-N16B1	FC6A-N16B3	FC6A-N32B3	FC6A-N08A11
Input Points	8 (8/1 common)	16 (16/1 common)		32 (16/1 common)	8 (4/1 common)
Rated Input Voltage	24V DC sink/source input signal				100 to 120V AC
Input Voltage Range	0 to 28.8V DC				0 to 132V AC (50/60 Hz)
Rated Input Current	7 mA/point (24V DC)		5 mA/point (24V DC)		17 mA/point (120V AC, 60 Hz)
Input Impedance	3.4 kΩ		4.4 kΩ		0.8 kΩ (60 Hz)
OFF Voltage	5V maximum				20V maximum
ON Voltage	15V minimum				79V minimum
OFF Current	1.2 mA maximum		0.9 mA maximum		—
ON Current	4.2 mA minimum (at 15V DC)		3.2 mA minimum (at 15V DC)		—
Input Delay Time (24V DC)	Turn ON: 4.1ms, Turn OFF: 4.1ms				Turn ON: 25ms, Turn OFF: 30ms
Isolation	Between input terminals: Not isolated Internal circuit: Optocoupler-isolated				Between input terminals in the same common: Not isolated Between input terminals in different commons: Isolated Between input terminals and internal circuits: Optocoupler-isolated
External Load for I/O Interconnection	Not needed				
Signal Determination Method	Static				
Effect of Improper Input Connection	Both sink and source input signals can be connected. If any input exceeding the rated value is applied, permanent damage may be caused.				If any input exceeding the rated value is applied, permanent damage may be caused.
Cable Length	3m in compliance with electromagnetic immunity				—
Internal Current Draw	All Inputs ON	30mA (5V DC) 0mA (24V DC)	40mA (5V DC) 0mA (24V DC)	40mA (5V DC) 0mA (24V DC)	65mA (5V DC) 0mA (24V DC)
	All Inputs OFF	17mA (5V DC) 0mA (24V DC)	17mA (5V DC) 0mA (24V DC)	17mA (5V DC) 0mA (24V DC)	17mA (5V DC) 0mA (24V DC)
Internal Power Consumption (at 24V DC while all inputs ON)	0.20W	0.27W	0.27W	0.44W	0.27W
Connector	Type (on mother board)	—			
	Connector Insertion/Removal Durability	100 times minimum			
	Applicable Ferrule	1-wire: AI 0,5-8 WH (Phoenix Contact) 2-wire: AI-TWIN 2x0,5-10 (Phoenix Contact)		—	1-wire: AI 0,5-8 WH (Phoenix Contact) 2-wire: AI-TWIN 2x0,5-10 (Phoenix Contact)
Weight (approx.)	110g	105g	75g	110g	110g

- APEM
- Switches & Pilot Lights
- Control Boxes
- Emergency Stop Switches
- Enabling Switches
- Safety Products
- Explosion Proof
- Terminal Blocks
- Relays & Sockets
- Circuit Protectors
- Power Supplies
- LED Illumination
- Controllers
- Operator Interfaces
- Sensors
- AUTO-ID

Relay Output Module

Part No.	FC6A-R081	FC6A-R161	
Output Points	8 (4/1 common)	16 (8/1 common)	
Output Type	1NO		
Maximum Load Current	2A per point	8A per common	
Minimum Switching Load	1 mA/ 5V DC (reference value)		
Initial Contact Resistance	30 mΩ maximum		
Electrical Life	100,000 operations minimum (rated resistive load 1,800 operations/hour)		
Mechanical Life	20,000,000 operations minimum (no load 18,000 operations/hour)		
Rated Load	Resistive load: 240V AC 2A, 30V DC 2A Inductive load: 240V AC 2A (cos φ = 0.4) 30V DC 2A (L/R = 7 ms)		
Dielectric Strength	Between output and ground terminals: 2,300V AC, 1 minute Between output terminal and internal circuit: 2,300V AC, 1 minute Between output terminals (COMs): 2,300V AC, 1 minute		
Internal Current Draw	All outputs ON	35mA (5V DC) 50mA (24V DC)	
	All outputs OFF	17mA (5V DC) 0mA (24V DC)	
Internal Power Consumption (at 24V DC while all outputs ON)	1.44W	2.74W	
Connector	Insertion/Removal Durability	100 times minimum	
	Applicable Ferrule	1-wire: AI 0,5-10 (Phoenix Contact) 2-wire: AI-TWIN 2x0,5-10 (Phoenix Contact)	
Weight (approx.)	130g	140g	

Transistor Output Module

Part No.	FC6A-T08K1 FC6A-T08P1	FC6A-T16K1 FC6A-T16P1	FC6A-T16K3 FC6A-T16P3	FC6A-T32K3 FC6A-T32P3
Output Points	8 (8/1 common)	16 (16/1 common)		32 (16/1 common)
Output Type	FC6A-T□K□: Transistor sink output FC6A-T□P□: Transistor source output			
Rated Load Voltage	24V DC			
Operating Load Voltage Range	19.2 to 28.8V DC			
Maximum Load Current	0.5A per point		0.1A per point	
	3A per common		1A per common	
Output Delay	Turn ON Time		400 μs maximum	
	Turn OFF Time		450 μs maximum	
Isolation	Between output terminal and internal circuit: Optocoupler-isolated Between output terminals: Not isolated			
Voltage Drop (ON Voltage)	1V maximum (voltage between COM and output terminals when output is on)			
Inrush Current	1A maximum			
Leakage Current	0.1mA maximum			
Clamping Voltage	Approx. 50V			
Maximum Lamp Load	12W	2.4W		
Inductive Load	L/R = 10ms (28.8V DC 1Hz)			
External Current Draw	FC6A-T□K□: 100 mA maximum, 24V DC (power voltage at the +V terminal) FC6A-T□P□: 100 mA maximum, 24V DC (power voltage at the -V terminal)			
Overcurrent Protection	Transistor Sink Output: No Transistor Source Output: Yes			
Internal Current Draw	All outputs ON		25mA (5V DC) 15mA (24V DC)	
	All outputs OFF		17mA (5V DC) 0mA (24V DC)	
Internal Power Consumption (at 24V DC while all outputs ON)	0.53W	0.80W	1.50W	
Connector	Type (on mother board)	—		
	Insertion/Removal Durability	100 times minimum		
	Applicable Ferrule	1-wire: AI 0,5-10 (Phoenix Contact) 2-wire: AI-TWIN 2x0,5-10 (Phoenix Contact)		—
Weight (approx.)	110g	105g	75g	115g

- FC6A
- FT1A
- FL1F



Download catalogs and CAD from <http://eu.idec.com/downloads>

L-028

FC6A Micro Programmable Logic Controllers

Digital Mixed I/O Module

Part No.	FC6A-M08BR1	FC6A-M24BR1
Input Points	4 (4/1 common)	16 (16/1 common)
Rated Input Voltage	24V DC sink/source input signal	
Input Voltage Range	0 to 28.8V DC	
Rated Input Current	7 mA/point (24V DC)	
Input Impedance	3.4 kΩ	
OFF Voltage	5V maximum	
ON Voltage	15V minimum	
OFF Current	1.2 mA maximum	
ON Current	4.2 mA minimum (at 15V DC)	
Input Delay Time (24V DC)	Turn ON Time	4.1ms
	Turn OFF Time	4.1ms
Isolation	Between input terminals: Not isolated Internal circuit: Optocoupler-isolated	
External Load for I/O Interconnection	Not needed	
Signal Determination Method	Static	
Effect of Improper Input Connection	Both sinking and sourcing input signals can be connected. If any input exceeding the rated value is applied, permanent damage may be caused.	
Cable Length	3m in compliance with electromagnetic immunity	
Output Points	4 (4/1 common)	8 (4/1 common)
Output Type	1NO	
Maximum Load Current	2A per point 7A per common	
Minimum Switching Load	1 mA/ 5V DC (reference value)	
Initial Contact Resistance	30 mΩ maximum	
Electrical Life	100,000 operations minimum (rated resistive load 1,800 operations/hour)	
Mechanical Life	20,000,000 operations minimum (no load 18,000 operations/hour)	
Rated Load	Resistive load: 240V AC 2A, 30V DC 2A Inductive load: 240V AC 2A (cos φ = 0.4), 30V DC 2A (L/R = 7 ms)	
Dielectric Strength	Between output and ground terminals: 2,300V AC, 1 minute Between output terminal and internal circuit: 2,300V AC, 1 minute Between output terminals (COMs): 2,300V AC, 1 minute	
Internal Current Draw	All I/Os ON	30mA (5V DC), 25mA (24V DC)
	All I/Os OFF	17mA (5V DC), 0mA (24V DC)
Internal Power Consumption (at 24V DC while all I/Os are ON)	0.80W	
Connector	Insertion/Removal Durability	100 times minimum
	Applicable Ferrule	1-wire: AI 0.5-10 (Phoenix Contact) 2-wire: AI-TWIN 2×0.5-10 (Phoenix Contact)
Weight (approx.)	120g	165g

Temperature derating curves: Input voltage vs. I/O Simultaneous ON Ratio (%)

FC6A-N08B1

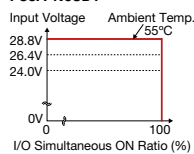

FC6A-N16B1

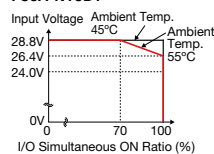

FC6A-N16B3/FC6A-N32B3

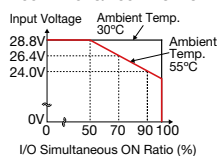

FC6A-N08A11

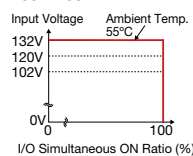

FC6A-M08BR1

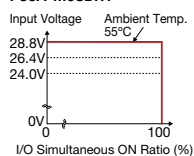

FC6A-M24BR1

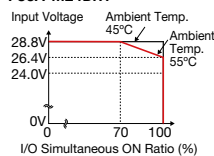

Input Internal Circuit

FC6A-N08B1/FC6A-N16B1

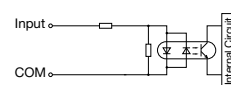

FC6A-N16B3/FC6A-N32B3

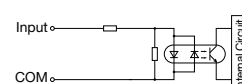

FC6A-M08BR1/FC6A-M24BR1

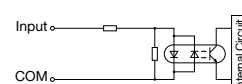

FC6A-N08A11

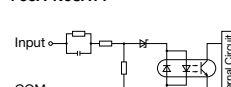

Output Internal Circuit

FC6A-T08K1/FC6A-T16K1
FC6A-T16K3/FC6A-T32K3

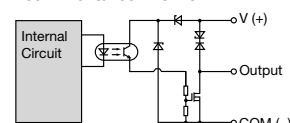

FC6A-T08P1/FC6A-T16P1
FC6A-T16P3/FC6A-T32P3

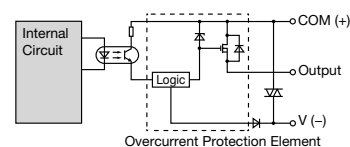

See L-015 for part numbers.

FC6A Micro Programmable Logic Controllers

Controllers

Analog I/O Modules

Analog Module

Specifications

Part No.	FC6A-J2C1	FC6A-J4A1	FC6A-J8A1	FC6A-L06A1	FC6A-L03CN1	FC6A-J4CN1	FC6A-J4CH1Y	FC6A-J8CU1	FC6A-K4A1	FC6A-K2A1
Input Points	2	4	8	4	2	4	4	8	-	-
Input Signal Type	Voltage (0 to 10V) Voltage (-10 to +10V) Current (0 to 20mA) Current (4 to 20mA)				Voltage (0 to 10V) Voltage (-10 to +10V) Current (0 to 20mA) Current (4 to 20mA) Thermocouple Resistance Thermometer		Thermocouple	Thermocouple Thermistor (NTC, PTC)	-	-
Output Points	-	-	-	2	1	-	-	-	4	2
Output Signal Style	-	-	-	Voltage (0 to 10V) Voltage (-10 to +10V) Current (0 to 20mA) Current (4 to 20mA)	-	-	-	-	Voltage (0 to 10V) Voltage (-10 to +10V) Current (0 to 20mA) Current (4 to 20mA)	-
External Power Supply	Rated Power Voltage 24V DC, Allowable Voltage Range 20.4 to 28.8V DC									
External Current Draw (24V DC) (*1)	25mA	30mA	40mA	100mA	80mA	40mA	40mA	30mA	125mA	70mA
Internal Power Consumption (5V DC)	40mA max.	45mA max.	40mA max.	55mA max.	55mA max.	50mA max.	50mA max.	45mA max.	50mA max.	40 mA max.
Internal Power Consumption (at 24V DC while all I/Os are ON)	0.27W	0.30W	0.27W	0.37W	0.37W	0.34W	0.34W	0.30W	0.34W	0.27W
Connector	Insertion/Removal Durability: 100 times minimum									
	Applicable Ferrule: 1-wire: AI 0,5-10 (Phoenix Contact), 2-wire: AI-TWIN 2x0,5-10 (Phoenix Contact)									
Weight (approx.)	115g	110g	110g	110g	115g	110g	115g	110g	115g	115g

*1) The external current draw is the value when all the analog inputs are used and the analog output value is at 100%.

Input Specifications

Part No.	FC6A-J2C1		FC6A-J8A1		FC6A-J4A1/FC6A-L06A1			
Input Signal Type	Voltage Input		Current Input		Voltage Input			
Input Range	0 to 10V -10 to +10V		0 to 20mA 4 to 20mA		0 to 10V -10 to +10V			
Input Impedance	1MΩ maximum		50Ω maximum		1MΩ maximum			
Input Detection Current	-		-		-			
AD Conversion	Sampling Time	1ms		1ms or 10ms (selectable with WindLDR)		1ms or 10ms (selectable with WindLDR)		
	Sampling Repetition Time	Sampling time × valid input channels						
	Total Input System Transfer Time	Sampling time + sampling repetition time + 1 scan time						
	Type of Input	Single-ended input						
	Operating Mode	Self-scan						
Conversion Method	Σ Δ type ADC							
Input Error	Maximum Error at 25°C	±0.1% of full scale		±0.2% of full scale		±0.2% of full scale		
	Cold Junction Compensation Error	-		-		-		
	Temperature Coefficient	±0.006% of full scale/°C		±0.01% of full scale/°C		±0.01% of full scale/°C		
Data	Digital Resolution	65,536 increments (16 bits)		65,536 increments (16 bits) (*1)		4,096 increments (12 bits) *FC6A-J8A1: can be expanded to 16-bit input (selectable with WindLDR)		
	Input per Resolution	0 to 10V: 0.15mV -10 to +10V: 0.30mV	0 to 20mA: 0.30µA 4 to 20mA: 0.244µA	0 to 10V: 0.15mV -10 to +10V: 0.30mV	0 to 20mA: 0.30µA 4 to 20mA: 0.244µA	0 to 10V: 2.44mV -10 to +10V: 4.88mV	0 to 20mA: 4.88µA 4 to 20mA: 3.91µA	
	Data Type in Application Program	Optional: -32,768 to 32,767 (selectable for each channel) (*2)						
	Monotonicity	Yes						
Noise Resistance	Input Data Out of Range	Detectable (*3)						
	Input Filter	Soft filter (0 to 10 s, selectable in increments of 0.1 s) (selectable with WindLDR)						
	Recommended Cable for Noise Immunity	Pair shielded cable						
Isolation	Crosstalk	1LSB maximum						
	Effect of Improper Input Connection	No damage						
Maximum Permanent Allowed Overload (No Damage)	30V DC (*4)		160mA (*5)		30V DC		160mA (*5)	
Selection of Analog Input Signal Type	Selectable with WindLDR							
Calibration or Verification to Maintain Rated Accuracy	Not possible							

*1) Binary data (16 bits) and optional range (16 bits) can be used with the following versions.

FC6A-J8A1: Version 200 or later WindLDR: Version 8.6.0 or later

If a FC6A-J8A1 that does not correspond to the above version numbers is set to binary data (16 bits) or optional range (16 bits), an error will occur and the module will operate as binary data (12 bits).

*2) The arbitrary setting is a function that uses the digital resolution data by scaling it to arbitrary data (that arbitrarily sets the lower limit value and the upper limit value). The range setting (-32,768 to 32,767) is specified with data registers.

*3) Input data out of range is reflected in the status of the analog I/O module.

*4) FC6A Ver. Ver. 200 and later: voltage input 13V DC, current input 40mA DC

*5) If a current of 160mA or more is applied at 25°C, a protection function of the input circuit will function to reduce the current. However, if a voltage 30V DC or more is applied, the circuit will be damaged.



Download catalogs and CAD from <http://eu.idec.com/downloads>

L-030

FC6A Micro Programmable Logic Controllers

Controllers

Input Specifications

Part No.	FC6A-L03CN1/FC6A-J4CN1				FC6A-J4CH1Y		FC6A-J8CU1		
Input Signal Type	Voltage Input	Current Input	Resistance Thermometer	Thermocouple	Thermocouple	Thermocouple	NTC Thermistor	PTC Thermistor	
Input Range	0 to 10V DC -10 to +10V	0 to 20mA 4 to 20mA	Pt100, Pt1000 3-wire type (-200 to 850°C) Ni100, Ni1000 3-wire type (-60 to 180°C)	Type K (-200 to +1,300°C) Type J (-200 to +1,000°C) Type R (0 to 1,760°C) Type S (0 to 1,760°C) Type B (0 to 1,820°C) Type E (-200 to +800°C) Type T (-200 to +400°C) Type N (-200 to +1,300°C) Type C (0 to 2,315°C)			-90 to +150°C	100 to 10,000Ω	
Input Impedance	1 MΩ minimum	50Ω maximum	1 MΩ minimum	1 MΩ minimum	1 MΩ minimum	1 MΩ minimum	1 MΩ minimum	1 MΩ minimum	
Input Detection Current	—	—	0.1mA maximum	0.1mA maximum	0.1mA maximum	0.1mA maximum	0.1mA maximum	0.1mA maximum	
AD Conversion	Sampling Time	10ms, 100ms (selectable using WindLDR)		104ms	30ms, 120ms (selectable using WindLDR)		104ms		
	Sampling Repetition Time	Sampling time × valid input channels							
	Total Input System Transfer Time	Sampling time + sampling repetition time + 1 scan time							
	Type of Input	Single-ended input			Differential input	Single-ended input			
	Operating Mode	Self-scan							
Conversion Method	Σ Δ type ADC								
Input Error	Maximum Error at 25°C	±0.2% of full scale		FC6A-L03CN1: ±0.1% of full scale + cold junction compensation error FC6A-J4CN1: ±0.2% of full scale + cold junction compensation error (*3)	±0.2% of full scale + cold junction compensation error (*3)		±0.2% of full scale + cold junction compensation error (*3)		
	Cold Junction Compensation Error	—	—	—	±4°C maximum		±4°C maximum		
	Temperature Coefficient	FC6A-L03CN1: 0.006%/°C of full scale FC6A-J4CN1: 0.01%/°C of full scale			0.01%/°C of full scale		0.01%/°C of full scale		
Data	Digital Resolution	65,536 increments (16 bits)		Pt100: approx. 10,500 increments (14 bits) Pt1,000: approx. 8,000 increments (13 bits) Ni100: approx. 2,400 increments (12 bits) Ni1,000: approx. 2,400 increments (12 bits)	Type K: approx. 15,000 increments (14 bits) Type J: approx. 12,000 increments (14 bits) Type R: approx. 17,600 increments (15 bits) Type S: approx. 17,600 increments (15 bits) Type B: approx. 18,200 increments (15 bits) Type E: approx. 10,000 increments (14 bits) Type T: approx. 6,000 increments (13 bits) Type N: approx. 15,000 increments (14 bits) Type C: approx. 23,150 increments (15 bits)			NTC: approx. 2,400 increments (12 bits) PTC: approx. 9,900 increments (14 bits)	
	Input Value of LSB	0 to 10V: 0.15mV -10 to +10V: 0.30mV	0 to 20mA: 0.30μA 4 to 20mA: 0.244μA	0.1°C	0.1°C	0.1°C	0.1°C	0.1°C	1Ω
	Data Type in Application Program	Optional: selectable for each channel from -32,768 to 32,767 (*1)							
	Monotonicity	Yes							
	Input Data Out of Range	Detectable (*2)							
	Noise Resistance	Input Filter	Soft filter (0 to 10 s, selectable in increments of 0.1 s) (selectable with WindLDR)						
		Recommended Cable for Noise Immunity	Pair shielded cable		Pair cable				
Crosstalk		1 LSB maximum							
Isolation	Between input and power circuit	Transformer-isolated							
	Between input and internal circuit	Optocoupler-isolated							
	Between inputs	Not isolated			Optocoupler-isolated		Not isolated		
Effect of Improper Input Connection	No damage								
Maximum Permanent Allowed Overload (No Damage)	30V DC (*4)	160mA (*5)	—						
Selection of Input Signal Type and Input Range	Selectable with WindLDR								
Calibration or Verification to Maintain Rated Accuracy	Not possible								

*1) The data processed in the analog I/O module can be linear-converted to a value between -32,768 and 32,767. The optional range designation, and analog I/O data minimum and maximum values can be selected using data registers allocated to analog I/O modules.

*2) When an error is detected, a corresponding error code is stored to a data register allocated to analog I/O operating status.

*3) R, S: ±6 (0 to 200°C)

B: no compensation

K, J, E, T, N: ±0.4% of full scale (0°C maximum)

*4) For models earlier than V200, the maximum permanent allowed overload is 13V DC at voltage input and 40mA at current input.

*5) If a current of 160mA or more is applied at 25°C, a protection function of the input circuit will function to reduce the current. However, if a voltage 30V DC or more is applied, the circuit will be damaged.

Analog I/O Modules

Analog Modules

Output Specifications

Part No.		FC6A-K2A1/FC6A-K4A1	FC6A-L06A1	FC6A-L03CN1
Output Signal Style/Output Range	Voltage	0 to 10V DC -10 to +10VDC		
	Current	0 to 20mA 4 to 20mA		
Load	Impedance	Voltage output: 1 kΩ minimum Current output: 300Ω maximum		
	Load Type	Resistive load		
DA Conversion	DA Conversion Time	1ms		
	Output Update Interval	1ms		
	Total Output System Transfer Time	DA Conversion Time + Output Update Interval + 1 scan time		
Output Error	Maximum Error at 25°C	±0.2% of full scale	±0.1% of full scale	±0.2% of full scale
	Temperature Coefficient	±0.01%/°C of full scale	±0.006%/°C of full scale	±0.01%/°C of full scale
	Repeatability after Stabilization Time	±0.4% of full scale		
	Output Voltage Drop	No damage		
	Non-linearity	±0.2% of full scale	±0.01%/°C of full scale	±0.2% of full scale
	Output Ripple	20mV maximum		
	Overshoot	0%		
Total Error	±1% of full scale			
Data	Digital Resolution	4,096 increments (12 bits)		
	Output Value of LSB	Voltage	0 to 10V DC: 2.44mV -10 to +10V DC: 4.88mV	
		Current	0 to 20mA: 4.88µA 4 to 20mA: 3.91µA	
	Data Type in Application Program	Optional: -32,768 to 32,767 (selected for each channel)		
	Monotonicity	Yes		
Current Loop Open	Undetectable			
Noise Resistance	Recommended Cable for Noise Immunity	Pair shielded cable		
	Crosstalk	1LSB		
Isolation	Between output and power circuit	Transformer-isolated		
	Between output and internal circuit	Optocoupler-isolated		
Effect of Improper Output Connection	No damage			
Selection of Analog Output Signal Type	Selectable with WindLDR			
Calibration or Verification to Maintain Rated Accuracy	Not possible			

- APEM
- Switches & Pilot Lights
- Control Boxes
- Emergency Stop Switches
- Enabling Switches
- Safety Products
- Explosion Proof
- Terminal Blocks
- Relays & Sockets
- Circuit Protectors
- Power Supplies
- LED Illumination
- Controllers**
- Operator Interfaces
- Sensors
- AUTO-ID
- FC6A
- FT1A
- FL1F

Specifications (PID Module)

Input Range

Part No.	FC6A-F2MR1/FC6A-F2M1		
Input	Input Range (Digital Resolution)		Input Value per Step
K	-200 to 1,370°C	-328 to 2,498°F	1°C (°F)
	-200.0 to 400.0°C	-328.0 to 752.0°F	0.1°C (°F)
J	-200 to 1,000°C	-328 to 1,832°F	1°C (°F)
R	0 to 1,760°C	32 to 3,200°F	1°C (°F)
S	0 to 1,760°C	32 to 3,200°F	1°C (°F)
B	0 to 1,820°C	32 to 3,308°F	1°C (°F)
E	-200 to 800°C	-328 to 1,472°F	1°C (°F)
T	-200.0 to 400.0°C	-328.0 to 752.0°F	0.1°C (°F)
N	-200 to 1,300°C	-328 to 2,372°F	1°C (°F)
PL-II	0 to 1,390°C	32 to 2,534°F	1°C (°F)
C (W/Re5-26)	0 to 2,315°C	32 to 4,199°F	1°C (°F)
Pt100	-200 to 850°C	-328 to 1,562°F	1°C (°F)
	-200.0 to 850.0°C	-328.0 to 1,562.0°F	0.1°C (°F)
JPt100	-200 to 500°C	-328 to 932°F	1°C (°F)
	-200.0 to 500.0°C	-328.0 to 932.0°F	0.1°C (°F)
DC 4 to 20mA	-2,000 to 10,000 (12,000 increments) (*1)		1.333µA
DC 0 to 20mA	-2,000 to 10,000 (12,000 increments) (*1)		1.666µA
DC 0 to 1V	-2,000 to 10,000 (12,000 increments) (*1)		0.083mA
DC 0 to 5V	-2,000 to 10,000 (12,000 increments) (*1)		0.416mA
DC 1 to 5V	-2,000 to 10,000 (12,000 increments) (*1)		0.333mA
DC 0 to 10V	-2,000 to 10,000 (12,000 increments) (*1)		0.833mA

*1) Linear-conversion is possible.



Download catalogs and CAD from <http://eu.idec.com/downloads>

FC6A Micro Programmable Logic Controllers

PID Modules

Ratings

Part No.	FC6A-F2MR1		FC6A-F2M1	
Power Voltage	24V DC (external power), 5V DC (internal power)			
Allowable Voltage Range	20.4 to 28.8V DC			
Maximum Power Consumption	3.6W			
Internal Power Consumption	65mA (5V DC)			
Control Mode	Independent PID Control	Possible		
	Heating/Cooling Control	Possible (overlapping deadband settings available) (*1)		
	Difference Input Temperature Control	Possible (*1)		
	Cascade Control	Possible (*1)		
Input Points	2ch			
Input Type Input Range	Thermocouple	K, J, R, S, B, E, T, N, PL-II, C (W/Re5-26) External resistance: 100Ω maximum		
	Resistance Thermometer	Pt100, JPt100, 3-wire type		
	Current Input	0 to 20 mA DC, 4 to 20 mA DC Input impedance: 50Ω		
	Voltage Input	0 to 1V DC Input impedance: 1MΩ minimum 0 to 5V DC, 1 to 5V DC, 0 to 10V DC Input impedance: 100kΩ minimum		
AD Conversion	Sampling Time	100 ms		
	Sampling Repetition Time	100 ms		
	Total Input System Transfer Time	Sampling time + sampling repetition time + 1 scan time		
	Type of Input	Differential input		
	Conversion Method	Σ Δ type ADC		
Maximum Error at 25°C	Thermocouple Input	±0.2% of full scale or ±2°C (4°F), whichever is greater However, R, S inputs: 0 to 200°C (0 to 400°F): ±6°C (12°F) B input: 0 to 300°C (0 to 600°F) Accuracy is not guaranteed. K, J, E, T, N inputs: Less than 0°C (32°F): ±0.4% of full scale		
	Resistance Thermometer Input	±0.1% of full scale or ±1°C (2°F), whichever is greater		
	Voltage/Current Inputs	±0.2% of full scale		
Cold Junction Temperature Compensation Accuracy	±1°C at 0 to 55°C			
Temperature Coefficient	±0.005%/°C of full scale			
Noise Resistance	Input Filter	Yes		
	Recommended Cable for Noise Immunity	Pair shielded cable (current/voltage)/Pair cable (temperature input)		
	Cross Talk	None		
Isolation	Between input and power circuit	Transformer-isolated		
	Between input and internal circuit	Optocoupler-isolated		
	Between inputs	Optocoupler-isolated		
Output Points	2ch			
Output	Relay output: 1NO Rated load: 5A 250V AC/30V DC (resistive load) 3A 250V AC (inductive load cos φ=0.4) 3A 30V DC (inductive load VR=7ms) Minimum open/closed load: 10 mA 5V DC (reference value) Electrical life: 100,000 cycles (at the maximum rating of resistive load)	Non-contact voltage output (for SSR drive) 12V DC±15% Maximum 40 mA (short circuit protected) Analog current output 4 to 20 mA DC Load resistance: 550Ω maximum Analog output digital resolution: 1,000 (10 bits) LSB input value: 0.016 mA		
	Recommended Cable for Noise Immunity	Pair shielded cable		
Noise Resistance	Cross Talk	None		
	Between output and power circuit	Transformer-isolated		
Isolation	Between input and internal circuit	Optocoupler-isolated		
	Weight (approx.)	140g		

*1) Dual channel input is required for one loop control.

FC6A Micro Programmable Logic Controllers

Controllers

Input Circuit

FC6A-J2C1/FC6A-J4A1/FC6A-J8A1/FC6A-L06A1

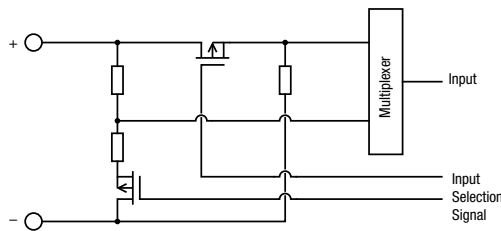

FC6A-J8CU1

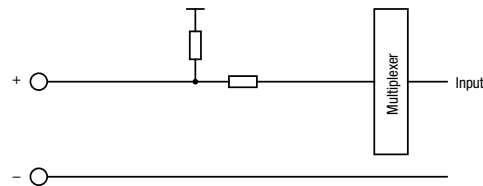

FC6A-J4CN1/FC6A-L03CN1

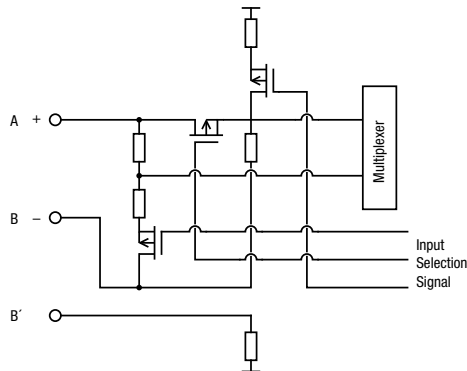

FC6A-F2M1/FC6A-F2MR1

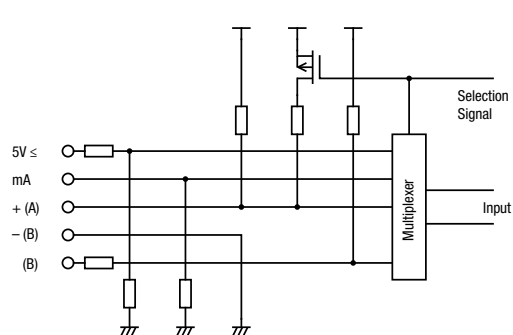

FC6A-J4CH1Y

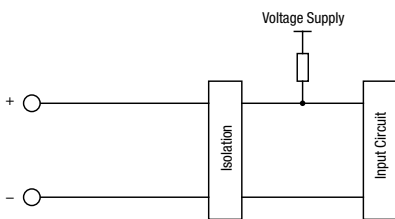

Output Circuit

FC6A-L03CN1/FC6A-L06A1/FC6A-K2A1/FC6A-K4A1

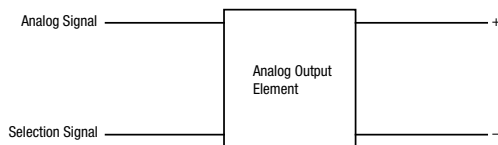

FC6A-F2M1
(Non-contact voltage output for SSR drive)

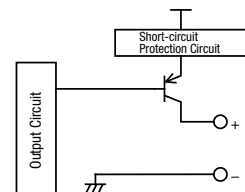

FC6A-F2M1 (current output)

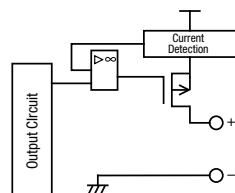

FC6A-F2MR1

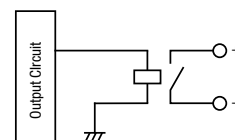

See L-015 for part numbers.

- APEM
- Switches & Pilot Lights
- Control Boxes
- Emergency Stop Switches
- Enabling Switches
- Safety Products
- Explosion Proof
- Terminal Blocks
- Relays & Sockets
- Circuit Protectors
- Power Supplies
- LED Illumination
- Controllers
- Operator Interfaces
- Sensors
- AUTO-ID

- FC6A
- FT1A
- FL1F

Download catalogs and CAD from <http://eu.idec.com/downloads>

L-034

FC6A Micro Programmable Logic Controllers

HMI Module/Communication Module

HMI Module Specifications

General

Part No.	FC6A-PH1
Power Consumption Inside Module (without connection cartridge)	100mA (5V) 15mA (24V)
Cartridge (option)	One analog cartridge can be added Any cartridge can be added when using on Plus CPU module
Weight (approx.)	170g

Operation

Part No.	FC6A-PH1
Operation Method	Rubber Switch
Operating Force	2.0N minimum
Mechanical Life	10,000 operations
Multiple Operation	Possible

Display

Part No.	FC6A-PH1	
Display	STN Monochrome LCD	
Color/Shade	Monochrome	
Effective Display Area	47.98W × 8.22H mm	
Display Resolution	192W × 64H pixels	
View Angle	Right and left 30°, up 20°, down 40°	
Contrast adjustment	Not possible	
Backlight	LED (green)	
Brightness	45 cd/m ²	
Brightness Adjustment	Not possible	
Backlight Control	ON/OFF	
Backlight Replacement	Not possible	
Display Character Size	1/2 size	8 × 16 pixels (JIS 8-bit code, Western European language ISO 8859-1, Cyrillic ANS1251)
	Full size	16 × 16 pixels (Japanese JIS first level characters, simplified Chinese)
Quantity of Characters	1/2 size	24 characters × 4 lines
	Full size	12 characters × 4 lines
Character Attribute	Blink, reverse	

HMI Ethernet Port

Part No.	FC6A-PH1	
Communication	Complies with IEEE802.3	
Transmission speed	10BASE-T, 100BASE-TX	
Protocol	Datalink layer: IP/ARP Network layer: TCP/UDP, ICMP Application layer: DHCP, DNS, HTTP, SMTP	
Connector	RJ45	
Cable	CAT 5. STP	
Maximum Cable Length	100m	
Isolation from Internal Circuit	Pulse transformer isolation	
Major Functions	Remote Maintenance	Uploading, downloading and monitoring user programs using WindLDR via Ethernet Number of connections: 8
	Web Server	5MB max. total size of system web page and user web page (system web page: about 500KB) Number of connections: 8 maximum Authentic method: digest authentication
	HMI Module System Software V.1.20 and later	
	Send E-mail	Sends preregistered e-mails. Up to 255 types of e-mails can be sent. Authentic method: SMTP-Auth (login), SMTP-Auth (CRAM-MD5), SMTPs Encoding method: BASE64 encode selectable
	E-mail Size	The maximum size of texts for To or Cc is 512 bytes. (*1) E-mail subject: 255 bytes maximum E-mail body: 4,096 bytes maximum Attached CSV file: 4,096 bytes maximum (includes spaces, separator characters, and newlines)

*1) Comma (,) is inserted as a separating character between e-mail addresses.

Communication Module Specifications

General

Part No.	FC6A-SIF52	
No. of Ports	2	
No. of Connectable CPU	15 max. (when using an unibody expansion interface modules)	
Communication Type	RS232C or RS485 selectable (per port)	
Maximum Baud Rate	115,200 bps	
No. of Slaves	RS485: 31 (per port)	
Maintenance Communication	Possible	
Modbus Communication	Possible	
Datalink	Possible	
Isolation	Between ports: transformer-isolated Between input circuits and communication: transformer- and optcoupler-isolated	
Maximum Cable Length	RS232C: 15m RS485: 1,200m	
Recommended Cable	RS232C: 0.2mm ² shielded 6-core cable RS485: 0.3mm ² shielded twisted pair cable (2P)	
Power Consumption Inside Module (without connection cartridge)	24V DC: 35mA, 5V DC: 35mA	
Connector	Insertion/Removal Durability	100 times minimum
	Applicable Ferrule	1-wire: AI 0,5-10 (Phoenix Contact) 2-wire: AI-TWIN 2×0,5-10 (Phoenix Contact)
Weight	110g	

Expansion Interface Modules/Cartridge Base Modules

Specifications

Expansion Interface Modules

Unibody Type

Part No.		FC6A-EXM2
I/O Expansion	Between CPU module and expansion interface module: Connectable I/O modules	7 maximum (224 I/Os maximum)
	Beyond the expansion interface module: Connectable I/O modules	8 maximum (256 I/Os maximum)
Rated Power Voltage		24V DC
Allowable Voltage Range		20.4 to 28.8V DC
Power Consumption	Internal power (supplied from CPU module)	20 mA (5V DC), 0 mA (24V DC)
	External power	With I/O modules (*1) 0.75A (26.4V DC)
Maximum Power Consumption (*1) (External Power)		0.5W (24V DC)
Allowable Momentary Power Interruption		10ms minimum (24V DC)
Isolation from Internal Circuit		Not isolated
No. of Connectable CPU		Plus: 11, All-in-One: 1
Connector	Insertion/Removal Durability	100 times minimum
	Applicable Ferrules	1-wire: AI 0,5-10 (Phoenix Contact) 2-wire: AI-TWIN 2×0,5-10 (Phoenix Contact)
Weight (approx.)		150g

*1) Power consumption by the expansion interface module and eight I/O modules.

Separate Master Type

Part No.		FC6A-EXM1M
No. of Connectable CPU		Plus: 1
No. of Connectable Slaves		10
Connector		RJ45
Cable		CAT. 5 or higher STP
Maximum Cable Length		100m
Isolation from Internal Circuit		Pulse transformer isolation
Power Consumption inside Module		DC5V: 75mA
Weight (approx.)		80g

Note: When using an expansion interface module (separate master type), the no. of connectable expansion modules to the basic expansion side of Plus CPU module is 5 maximum. (13 max. modules when using an expansion interface (unibody type))

Separate Slave Type

Part No.		FC6A-EXM1S
I/O Expansion	Between CPU module and expansion interface module: Connectable I/O modules	7 maximum (224 I/Os maximum)
	Beyond the expansion interface module: Connectable I/O modules	8 maximum (256 I/Os maximum)
Rated Power Voltage		24V DC
Allowable Voltage Range		20.4 to 28.8V DC
Maximum Power Consumption (*1) (External Power)		24.5W
Allowable Momentary Power Interruption		10ms minimum (24V DC)
Connectable Expansion Modules		Digital I/O Module Analog I/O Module
Isolation from Internal Circuit	Between internal circuits and power supply	Not isolated
	Between input circuits and communication	Pulse transformer isolation
Connector	Insertion/Removal Durability	100 times minimum
	Applicable Ferrules	1-wire: AI 0.5-10 (Phoenix Contact) 2-wire: AI-TWIN 2×0.5-10 (Phoenix Contact)
Communication	Connector	RJ45
	Cable	CAT. 5 or higher STP
	Maximum Cable Length	100m
Weight (approx.)		165g

*1) Power consumption by the expansion interface module and seven I/O modules.

Cartridge Base Module

Part No.		FC6A-HPH1
No. of Connectable Cartridges		2
Connectable Cartridges		Communication cartridge, digital I/O cartridge, analog I/O cartridge
No. of Connectable CPU		Plus: 1
Weight (approx.)		95g



Download catalogs and CAD from <http://eu.idec.com/downloads>

L-036

FC6A Micro Programmable Logic Controllers

Communication Cartridge Specifications

Serial Communication

Part No.	FC6A-PC1	FC6A-PC3
Standards	EIA RS232C	EIA RS485
Maximum Baud Rate	115,200 bps	
Maintenance Communication	Possible	Possible
User Communication	Possible	Possible
Data Link Communication	Possible	Possible
Modbus RTU	Possible	Possible
Half-duplex Communication	—	Possible
Maximum Cable Length	5m	200m
Quantity of Slave Stations	—	31
Isolation between Internal Circuit and Communication Port	Not isolated	
RS485 Cable	Recommended Cable	0.2mm ² shielded 3-core cable
	Conductor Resistance	85 Ω/km maximum
	Shield Resistance	20 Ω/km maximum

Bluetooth Communication

Part No.	FC6A-PC4
Bluetooth Standard	Bluetooth ver 2.1 + EDR
Profile	SPP (Serial Port Profile) iAP (iPod Accessory Protocol)
Frequency Range	2,402 MHz to 2,480 MHz
Wireless Transmission Distance *1	10m (Class 2)
Multi-point Function	8 units
Communication Protocol	Maintenance communication protocol User communication protocol
Bluetooth Wireless Approved Regions *2	Japan, People's Republic of China, USA, Canada, Australia, New Zealand, Europe

*1 Connection effective range is affected by obstacles (human, metal, wall) and wave signal condition. Make sure to confirm the connection status before actual operation.

*2: Depending on countries or regions, evaluation on the device equipped with FC6A may be necessary.

Note: Communication performance (required time) in maintenance communication is as follows.

- User program upload equivalent to 10,000 steps: 40 seconds approx.
- User program download equivalent to 10,000 steps: 50 seconds approx.
- User program upload equivalent to 20,000 steps: 1 minute 20 seconds approx.
- User program download equivalent to 20,000 steps: 1 minute 40 seconds approx.
- 100KV CSV file retrieval: 30 seconds approx.
- 200KV CSV file retrieval: 60 seconds approx.

Digital I/O Cartridge Specifications

Input Cartridge

Part No.	FC6A-PN4
Input Points	4 (4/1 common)
Rated Input Voltage	12/24V DC sink/source input signal
Input Voltage Range	0 to 28.8V DC
Rated Input Current	2.5 mA/point (12V DC) 5mA/point (24V DC)
Input Impedance	4.4 kΩ
OFF Voltage	5V maximum
ON Voltage	8.5V minimum
OFF Current	0.9 mA maximum
ON Current	1.7 mA minimum (at 8.5V DC)
Input Delay Time (24V DC)	Turn ON: 0.5ms Turn OFF: 0.5ms
Isolation	Between input terminals: Not isolated Internal circuit: Optocoupler-isolated
External Load for I/O Interconnection	Not needed
Signal Determination Method	Static
Effect of Improper Input Connection	Both sink and source input signals can be connected. If any input exceeding the rated value is applied, permanent damage may be caused.
Internal Current Draw	All Inputs ON: 35mA (3.3V DC) 0mA (24V DC) All Inputs OFF: 30mA (3.3V DC) 0mA (24V DC)
Internal Power Consumption (at 24V DC while all inputs ON)	0.10W
Cable Length	3m in compliance with electromagnetic immunity
Applicable Ferrule	1-wire: AI 0.5-8 WH (Phoenix Contact)
Weight (approx.)	15g

Output Cartridge

Part No.	FC6A-PTK4	FC6A-PTS4
Output Points	4 sink (4/1 common)	4 source (4/1 common)
Rated Input Voltage	12/24V DC	
Input Voltage Range	10.2 to 28.8V DC	
Maximum Load Current	Per Point: 0.1A Per Common: 0.4A	
Output Delay	Turn ON: 450µs maximum Turn OFF: 450µs maximum	
Isolation	Between input terminals: Not isolated Internal circuit: Optocoupler-isolated	
Voltage Drop (ON Voltage)	1V max (voltage between COM and output terminal when output is on.)	
Inrush Current	1A	
Leakage Current	0.1mA maximum	
Clamping Voltage	Approx. 50V	
Maximum Lamp Load	2.4W	
Inductive Load	L/R=10ms (28.8V DC, 1Hz)	
External Current Draw	100mA maximum, 24V DC (power voltage at the +V terminal at source)	100mA maximum, 24V DC (power voltage at the -V terminal at source)
Overcurrent Protection	No	
Internal Current Draw	All Outputs ON: 35mA (3.3V DC) 0mA (24V DC) All Outputs OFF: 30mA (3.3V DC) 0mA (24V DC)	
Internal Power Consumption (at 24V DC while all outputs ON)	0.10W	
Applicable Ferrule	1-wire: AI 0.5-8 WH (Phoenix Contact)	
Weight (approx.)	15g	

Analog I/O Cartridge

General Specifications

Part No.	FC6A-PJ2A	FC6A-PJ2CP	FC6A-PK2AV	FC6A-PK2AW
Type	Voltage/Current Input	Temperature Input	Voltage Output	Current Output
No. of Points	2	2	2	2
Rated Voltage	5.0V, 3.3V (supplied from the CPU module)			
Power Consumption	5.0V: — 3.3V: 30mA		5.0V: 70mA 3.3V: 30mA	5.0V: 185mA 3.3V: 30mA
Weight (approx.)	15g			

Cartridges

Analog I/O Cartridge

Function Specifications

Part No.	FC6A-PJ2A		FC6A-PJ2CP		FC6A-PK2AV		FC6A-PK2AW		
Input Points	2		2		—		—		
Types of Inputs	Voltage Input	0-10V		—		—		—	
	Current Input	0-20mA, 4-20mA		—		—		—	
Input Range	Thermocouple	—		K, J, R, S, B, E, T, N, C		—		—	
	Resistance Thermometer	—		Pt100, Pt1000, NI100, NI1000 3-wire type		—		—	
Input Impedance	Voltage Input	1MΩ minimum		—		—		—	
	Current Input	250Ω maximum		—		—		—	
	Thermocouple	—		1MΩ minimum		—		—	
Allowable Conductor Resistance (per wire)	Resistance Thermometer	—		1MΩ minimum		—		—	
	Resistance Thermometer	N/A		10Ω maximum		—		—	
Type of Input	Single-ended input								
Sampling Time	10ms		250ms		—		—		
Sampling Repetition Time	20ms		500ms		—		—		
Total Input System Transfer Time	Sampling time + sampling repetition time + 1 scan time								
Operation Mode	Self-scan								
Conversion Method	SAR								
Input Error	Maximum Error at 25°C	±0.1% of full scale		±0.1%/°C of full scale Cold junction compensation error: 4.0°C maximum. However, R, S inputs: ±6°C (0 to 200°C) B: 0 to 300°C. Accuracy is not guaranteed. K, J, E, T, N inputs: less than ±0.4% of full scale (0°C)		—		—	
	Temperature Coefficient	±0.02%/°C of full scale		±0.02%/°C of full scale		—		—	
Output Points	—		—		2		2		
Types of Outputs	Voltage Output	—		—		0-10V		—	
	Current Output	—		—		—		4-20mA	
Types of Output Load	Impedance	—		—		2kΩ minimum		500Ω minimum	
	Load Type	—		—		Resistive load		Resistive load	
DA Conversion Time	—		—		40ms maximum		20ms maximum		
Output Update Interval	—		—		20ms		20ms		
Total Output Delay	—		—		DA conversion time + output update time + 1 scan time				
Output Error	Maximum Error at 25°C	—		—		±0.3% of full scale		±0.3% of full scale	
	Temperature Coefficient	—		—		±0.02%/°C of full scale		±0.02%/°C of full scale	
	Output Ripple	—		—		30mV maximum		30mV maximum	
	Overshoot	—		—		0%		0%	
Data	Digital Resolution	4,096 increments (12 bits)		Thermocouple input K: approx. 15,000 (14 bits) J: approx. 12,000 (14 bits) R: approx. 17,600 (15 bits) S: approx. 17,600 (15 bits) B: approx. 18,200 (15 bits) E: approx. 10,000 (14 bits) T: approx. 6,000 (13 bits) N: approx. 15,000 (14 bits) C: approx. 23,150 (15 bits) Resistance thermometer input Pt100: approx. 10,500 (14 bits) Pt1000: approx. 8,000 (13 bits) NI100: approx. 2,400 (12 bits) NI1000: approx. 2,400 (12 bits)		4,096 increments (12 bits)		4,096 increments (12 bits)	
	Output Value of LSB	2.44 mV (0-10V) 4.88 μA (0-20mA) 3.91 μA (4-20mA)		0.1°C or 0.18°F (thermocouple input) 0.1°C or 0.18°F (resistor thermometer input)		2.44 mV (0-10V)		3.91 μA (4-20mA)	
	Data Type in Application Program	-32,768 to 32,773 (selectable for each channel) (*2)		-32,768 to 32,773 (selectable for each channel) (*2)		0 to 4,095 (0-10V)		0 to 4,095 (4-20mA)	
	Monotonicity	Yes		Yes		Yes		Yes	
	Current Loop Open	—		—		—		Not detectable	
	Input Data Out of Range	Detectable (*1)		Detectable (*1)		—		—	
Noise Resistance	Recommended Cable	Pair shielded cable		Pair cable		Pair shielded cable		Pair shielded cable	
	Crosstalk	1LSB maximum		1LSB maximum		1LSB		1LSB	
Others	Selection of Output Signal Type	—		—		Voltage output only		Current output only	
	Calibration to Maintain Rated Accuracy	Not possible							
	Effect of Improper Input Connection	No damage		No damage		—		—	
	Effect of Improper Output Connection	—		—		No damage		No damage	

*1) When an error is detected, a corresponding error code is stored to a data register allocated to analog I/O operating status.

*2) The data processed in the analog I/O module can be linear-converted to a value between -32,768 and 32,767. The optional range designation, and analog I/O data minimum and maximum values can be selected using data registers allocated to analog I/O modules.



Download catalogs and CAD from <http://eu.idec.com/downloads>

FC6A Micro Programmable Logic Controllers

Digital I/O Cartridge Internal Circuit

FC6A-PN4

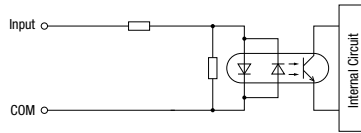

FC6A-PTK4

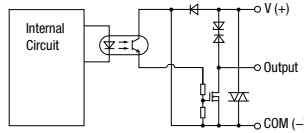

FC6A-PTS4

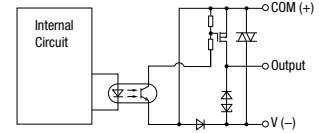

APEM

Switches & Pilot Lights

Control Boxes

Emergency Stop Switches

Enabling Switches

Dimensions

Plus CPU Modules

16 I/Os (8/8)

- FC6A-D16R1CEE
- FC6A-D16K1CEE
- FC6A-D16P1CEE

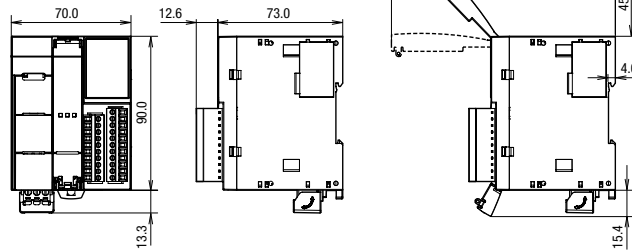

32 I/Os (16/16)

- FC6A-D32K3CEE
- FC6A-D32P3CEE

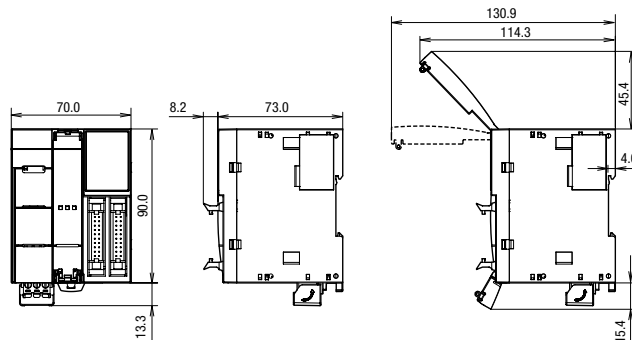

All dimensions in mm.

FC6A Micro Programmable Logic Controllers

Controllers

Dimensions

All-in-One CPU Modules

16 I/Os (8/8)

- FC6A-C16R1AE
- FC6A-C16R1CE
- FC6A-C16P1CE
- FC6A-C16K1CE

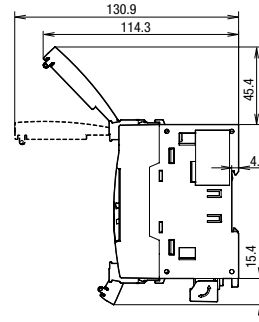
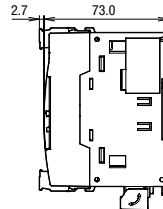
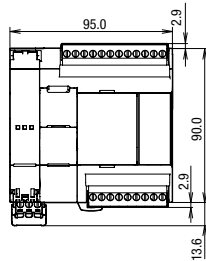

24 I/Os (14/10)

- FC6A-C24R1AE
- FC6A-C24R1CE
- FC6A-C24P1CE
- FC6A-C24K1CE

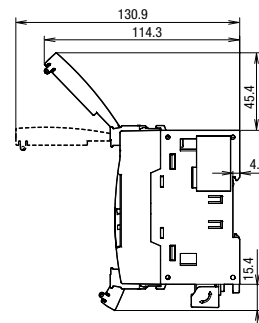
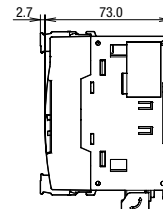
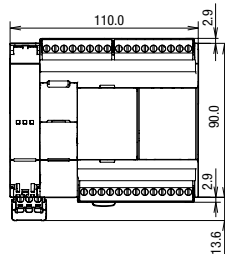

40 I/Os (24/16)

- FC6A-C40R1AE
- FC6A-C40R1CE
- FC6A-C40P1CE
- FC6A-C40K1CE
- FC6A-C40R1DE
- FC6A-C40P1DE
- FC6A-C40K1DE

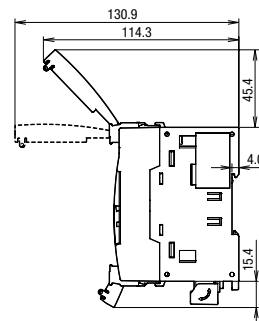
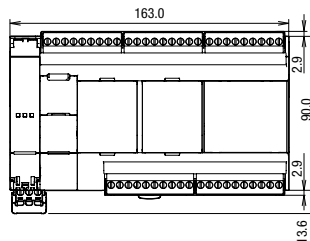

CAN J1939 All-in-One CPU Modules

40 I/Os (24/16)

- FC6A-C40R1AEJ
- FC6A-C40R1CEJ
- FC6A-C40P1CEJ
- FC6A-C40K1CEJ
- FC6A-C40R1DEJ
- FC6A-C40P1DEJ
- FC6A-C40K1DEJ

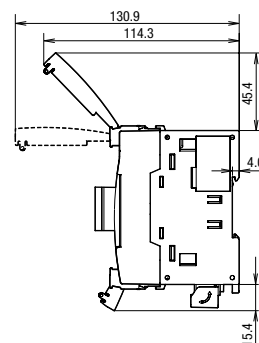
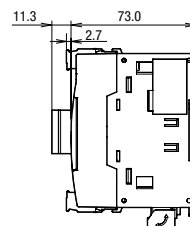
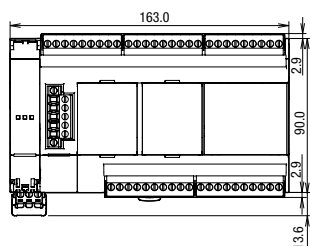

All dimensions in mm.

- APEM
- Switches & Pilot Lights
- Control Boxes
- Emergency Stop Switches
- Enabling Switches
- Safety Products
- Explosion Proof
- Terminal Blocks
- Relays & Sockets
- Circuit Protectors
- Power Supplies
- LED Illumination
- Controllers**
- Operator Interfaces
- Sensors
- AUTO-ID

- FC6A**
- FT1A
- FL1F

 Download catalogs and CAD from <http://eu.idec.com/downloads>

L-040

FC6A Micro Programmable Logic Controllers

HMI Module

FC6A-PH1

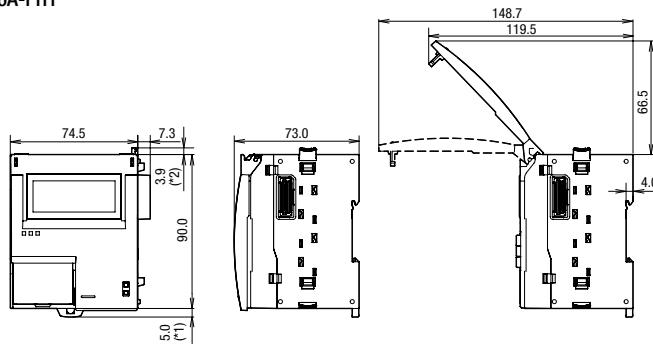

Expansion Interface Modules

Unibody Type

FC6A-EXM2

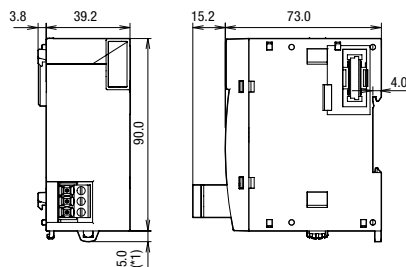

Separate Master Type

FC6A-EXM1M

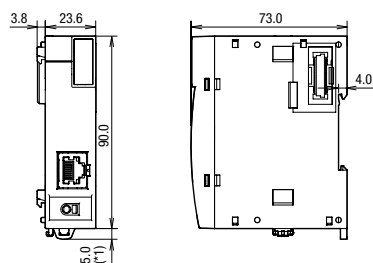

Separate Slave Type

FC6A-EXM1S

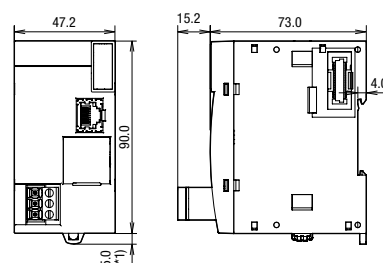

Cartridge Base Module

FC6A-HPH1

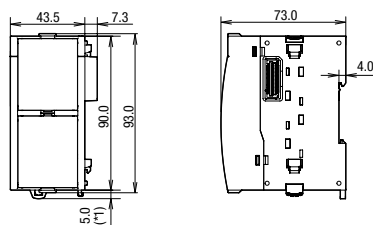

*1) 9.3 mm when the clamp is pulled out.
*2) 0 mm when the eject button is locked.

All dimensions in mm.

Dimensions

Expansion Modules

FC6A-N08B1/FC6A-N08A11/FC6A-R081
FC6A-T08K1/FC6A-T08P1/FC6A-M08BR1
FC6A-J2C1/FC6A-K2A1/FC6A-K4A1
FC6A-L03CN1

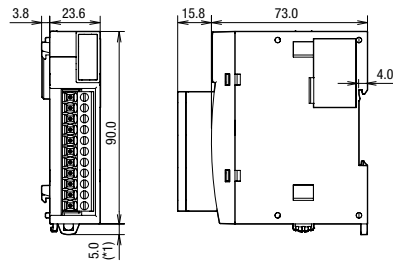

FC6A-N16B1/FC6A-R161/FC6A-T16K1
FC6A-T16P1/FC6A-J4A1/FC6A-J8A1
FC6A-J4CN1/FC6A-J4CH1Y/FC6A-J8CU1
FC6A-L06A1/FC6A-SIF52

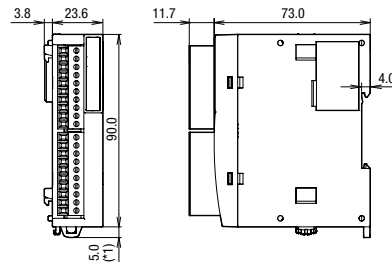

FC6A-N16B3/FC6A-T16K3
FC6A-T16P3

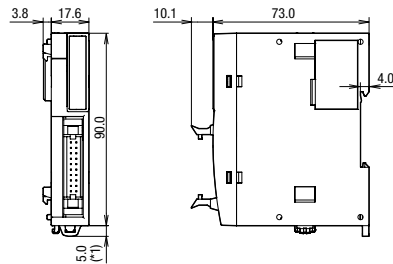

FC6A-N32B3/FC6A-T32K3
FC6A-T32P3

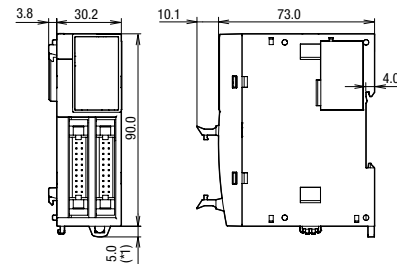

FC6A-M24BR1/FC6A-F2M1
FC6A-F2MR1

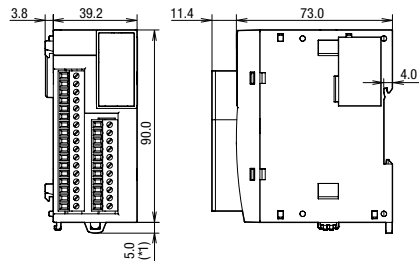

* 9.3 mm when the clamp is pulled out.
• See L-015 to L-016 for part numbers.

Cartridges

FC6A-PC1/FC6A-PC3/FC6A-PJ2A
FC6A-PK2AV/FC6A-PK2AW/FC6A-PJ2CP
FC6A-PN4/FC6A-PTK4/FC6A-PTS4

FC6A-PC4

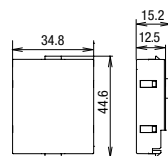
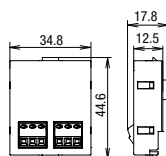

• See L-016 for part numbers.

All dimensions in mm.

Download catalogs and CAD from <http://eu.idec.com/downloads>

L-042

FC6A Micro Programmable Logic Controllers

Mounting Hole Layout

All-in-One/CAN J1939 All-in-One CPU Modules

Install FC6A directly to a flat panel using M4 pan head screws.

FC6A-C16R1AE
FC6A-C16R1CE
FC6A-C16K1CE
FC6A-C16P1CE

FC6A-C24R1AE
FC6A-C24R1CE
FC6A-C24K1CE
FC6A-C24P1CE

FC6A-C40R1AE/FC6A-C40R1CE/FC6A-C40K1CE
FC6A-C40P1CE/FC6A-C40R1DE/FC6A-C40K1DE
FC6A-C40P1DE/FC6A-C40R1AEJ/FC6A-C40R1CEJ
FC6A-C40K1CEJ/FC6A-C40P1CEJ/FC6A-C40R1DEJ
FC6A-C40K1DEJ/FC6A-C40P1DEJ

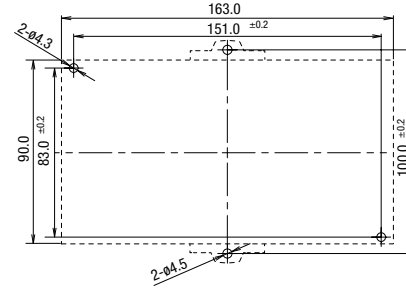
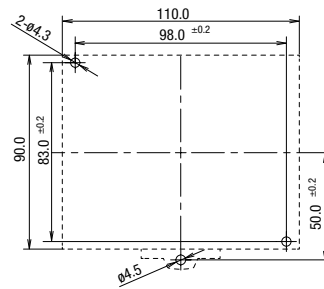
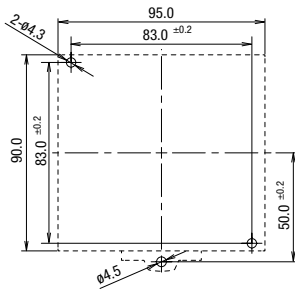

Plus CPU Modules

FC6A-D16R1CEE
FC6A-D16K1CEE
FC6A-D16P1CEE
FC6A-D32K3CEE
FC6A-D32K3CEE

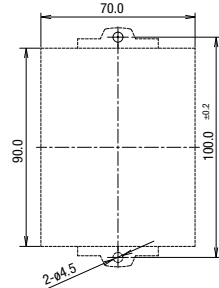

Expansion Modules

FC6A-PH1

FC6A-EXM1S

FC6A-HPH1

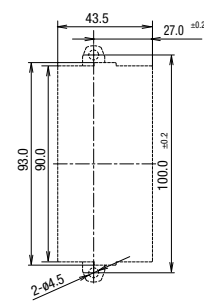
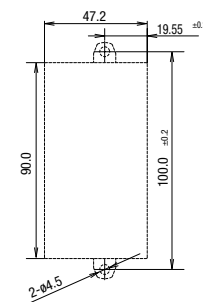
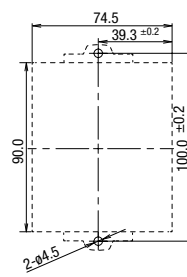

FC6A-N16B3
FC6A-T16K3
FC6A-T16P3

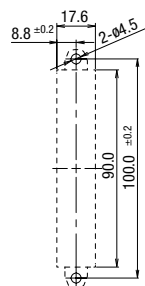

FC6A-N32B3
FC6A-T32K3
FC6A-T32P3

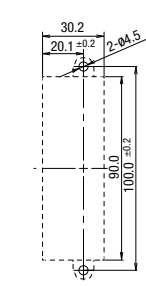

FC6A-F2M1
FC6A-F2MR1
FC6A-EXM2

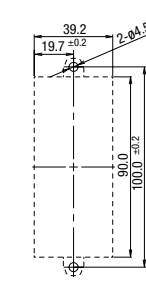

FC6A-SIF52
FC6A-EXM1M
FC6A-N08B1
FC6A-N08A11
FC6A-R081
FC6A-T08K1
FC6A-T08P1
FC6A-M08BR1
FC6A-N16B1
FC6A-R161
FC6A-T16K1
FC6A-T16P1
FC6A-J2C1
FC6A-K2A1
FC6A-K4A1
FC6A-L03CN1
FC6A-J4A1
FC6A-J8A1
FC6A-J4CN1
FC6A-J4CH1Y
FC6A-J8CU1
FC6A-L06A1

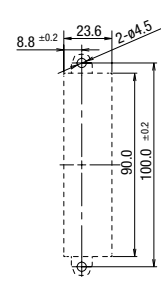

• See L-014 to L-016 for part numbers.

All dimensions in mm.

Instructions

Basic Instructions

Symbol	Function	Instruction Length (byte) (*1)	
		When using bit device	When using data register
AND	Series connection of NO contact	8	2
AND-LOD	Series connection of circuit blocks	8	
ANDN	Series connection of NC contact	12	
BPP	Restores the result of bit logical operation which was saved temporarily	4	
BPS	Saves the result of bit logical operation temporarily	4	
BRD	Reads the result of bit logical operation which was saved temporarily	4	
CC=	Equal to comparison of counter current value	12 to 16	
CC≥	Greater than or equal to comparison of counter current value	12 to 16	
CDP	Dual pulse reversible counter (0 to 65,535)	12 to 16	
CDPD	Double-word dual pulse reversible counter (0 to 4,294,967,295)	12 to 16	
CNT	Adding counter (0 to 65,535)	12 to 16	
CNTD	Double-word adding counter (0 to 4,294,967,295)	12 to 16	
CUD	Up/down selection reversible counter (0 to 65,535)	12 to 16	
CUDD	Double-word up/down selection reversible counter (0 to 4,294,967,295)	12 to 16	
DC=	Equal to comparison of data register value	12 to 24	
DC≥	Greater than or equal to comparison of data register value	12 to 24	
END	Ends a program	4	
JEND	Ends a jump instruction	4	
JMP	Jumps a designated program area	12	
LOD	Stores intermediate results and reads contact status	8	12
LODN	Stores intermediate results and reads inverted contact status	12	
MCR	Ends a master control	4	
MCS	Starts a master control	4	
OR	Parallel connection of NO contact	8	12
OR-LOD	Parallel connection of circuit blocks	8	
ORN	Parallel connection of NC contact	12	
OUT	Outputs the result of bit logical operation	8	
OUTN	Output the inverted result of bit logical operation	8	
RST	Reset	8	
SET	Set	8	
SFR	Forward shift register	12	
SFRN	Reverse shift register	12	
SOTD	Falling-edge differentiation output	8	
SOTU	Rising-edge differentiation output	8	
TIM	Subtracting 100-ms timer (0 to 6553.5 sec)	12 to 16	
TIMO	Subtracting 100-ms off-delay timer (0 to 6553.5 sec)	12 to 16	
TMH	Subtracting 10-ms timer (0 to 655.35 sec)	12 to 16	
TMHO	Subtracting 10-ms off-delay timer (0 to 655.35 sec)	12 to 16	
TML	Subtracting 1-sec timer (0 to 65535 sec)	12 to 16	
TMLO	Subtracting 1-sec off-delay timer (0 to 65535 sec)	12 to 16	
TMS	Subtracting 1-ms timer (0 to 65.535 sec)	12 to 16	
TMSO	Subtracting 1-ms off-delay timer (0 to 65.535 sec)	12 to 16	

*1) 1 step = 8 bytes

- APEM
- Switches & Pilot Lights
- Control Boxes
- Emergency Stop Switches
- Enabling Switches
- Safety Products
- Explosion Proof
- Terminal Blocks
- Relays & Sockets
- Circuit Protectors
- Power Supplies
- LED Illumination
- Controllers**
- Operator Interfaces
- Sensors
- AUTO-ID
- FC6A
- FT1A
- FL1F



Download catalogs and CAD from <http://eu.idec.com/downloads>

FC6A Micro Programmable Logic Controllers

Instructions

Advanced Instructions

Symbol	Function
NOP	No Operation
MOV	Move
MOVC	Move Character
MOVN	Move Not
IMOV	Indirect Move
IMOVN	Indirect Move Not
BMOV	Block Move
IBMV	Indirect Bit Move
IBMVN	Indirect Bit Move Not
NSET	N Data Set
NRS	N Data Repeat Set
XCHG	Exchange
TCCST	Timer/Counter Current Value Store
CMP=	Compare Equal To
CMP<>	Compare Unequal To
CMP<	Compare Less Than
CMP>	Compare Greater Than
CMP<=	Compare Less Than or Equal To
CMP>=	Compare Greater Than or Equal To
ICMP>=	Interval Compare Greater Than or Equal
LC=	Load Compare Equal To
LC<>	Load Compare Unequal To
LC<	Load Compare Less Than
LC>	Load Compare Greater Than
LC<=	Load Compare Less Than or Equal To
LC>=	Load Compare Greater Than or Equal To
ADD	Addition
SUB	Subtraction
MUL	Multiplication
DIV	Division
INC	Increment
DEC	Decrement
ROOT	Root
SUM	Sum
RNDM	Random
ANDW	AND Word
ORW	OR Word
XORW	Exclusive OR Word
SFTL	Shift Left
SFTR	Shift Right
BCDLS	BCD Left Shift
WSFT	Word Shift
ROTL	Rotate Left
ROTR	Rotate Right
HTOB	Hex to BCD
BTOH	BCD to Hex
HTOA	Hex to ASCII
ATOH	ASCII to Hex
BTOA	BCD to ASCII
ATOB	ASCII to BCD
ENCO	Encode
DECO	Decode
BCNT	Bit Count
ALT	Alternate Output
CVDT	Convert Data Type
DTDV	Data Divide
DTCB	Data Combine
SWAP	Data Swap

Instructions

Advanced Instructions

Symbol	Function
WEEK	Weekly Timer
YEAR	Yearly Timer
WKTIM	Week Timer
WKTBL	Week Table
MSG	Message
DISP	Display
DGRD	Digital Read
TXD	Transmit
ETXD	Transmit over Ethernet
RXD	Receive
ERXD	Transmit over Ethernet
LABEL	Label
LJMP	Label Jump
LCAL	Label Call
LRET	Label Return
DJNZ	Decrement Jump Non-zero
DI	Disable Interrupt
EI	Enable Interrupt
IOREF	I/O Refresh
HSCRF	High-speed Counter Refresh
FRQRF	Frequency Measurement Refresh
COMRF	Communication Refresh
XYFS	XY Format Set
CVXTY	Convert X to Y
CVYTX	Convert Y to X
AVRG	Average
PULS	Pulse Output
PWM	Pulse Width Modulation
RAMP	Ramp Pulse Output
RAMPL	Linear Interpolation with RAMP Pulse Output (*1)
ZRN	Zero Return
ARAMP	Advanced Ramp
ABS	Set the origin
JOG	Pulse with direction
PID	PID Control (FC5A compatible)
PIDA	PID Control
PIDD	PID with Derivative Decay
DTML	1-sec Dual Timer
DTIM	100-ms Dual Timer
DTMH	10-ms Dual Timer
DTMS	1-ms Dual Timer
TTIM	Teaching Timer
RAD	Degree to Radian
DEG	Radian to Degree
SIN	Sine
COS	Cosine
TAN	Tangent
ASIN	Arc Sine
ACOS	Arc Cosine
ATAN	Arc Tangent
LOGE	Natural Logarithm
LOG10	Common Logarithm
EXP	Exponent
POW	Power
FIFO	FIFO Format
FIEX	First-In Execute
FOEX	First-Out Execute
NDSRC	N Data Search

*1) Cannot be used on All-in-One model.

- APEM
- Switches & Pilot Lights
- Control Boxes
- Emergency Stop Switches
- Enabling Switches
- Safety Products
- Explosion Proof
- Terminal Blocks
- Relays & Sockets
- Circuit Protectors
- Power Supplies
- LED Illumination
- Controllers**
- Operator Interfaces
- Sensors
- AUTO-ID

- FC6A**
- FT1A
- FL1F



Download catalogs and CAD from <http://eu.idec.com/downloads>

L-046

FC6A Micro Programmable Logic Controllers

Instructions

Symbol	Function
TADD	Time Addition
TSUB	Time Subtraction
HTOS	HMS to Sec
STOH	Sec to HMS
HOUR	Hour Meter
SCRPT	Script
UMACRO	User-defined Macro
SCALE	Convert Analog Input
FLWA	Analog Flow Totalizer
FLWP	Pulse Flow Totalizer
PING	Ping
EMAIL	Send Email (*2)
DLOG	Data Logging
TRACE	Data Trace

*2) HMI module is necessary to use on All-in-One model.

APEM

Switches &
Pilot Lights

Control Boxes

Emergency
Stop Switches

Enabling
Switches

Safety Products

Explosion Proof

Terminal Blocks

Relays & Sockets

Circuit
Protectors

Power Supplies

LED Illumination

Controllers

Operator
Interfaces

Sensors

AUTO-ID

FC6A

FT1A

FL1F