

Smart**AXIS**
Controller

FT1A



• See website for details on approvals and standards.

Save installation space, wire, and time.

FT1A Controller x Small vivid LED display

Touch is an advanced, 3.8-inch display with integrated control and monitor functions. A bright LED backlight provides a vivid display.

Touch



Vertical
OK

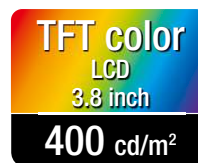

Touch

Touch is an advanced, 3.8-inch display with integrated control and monitor functions (same functionality as Lite 12-I/O type).



Pro

Compact, easy-to-use controller. Independent dual axis, high-speed counter, and interrupt input are available. Pro is equipped with an LCD



Lite

Compact, easy-to-use controller. Independent dual axis, high-speed counter, and interrupt input are available. Lite is a controller without an LCD.

SmartAXIS Touch

Save installation space, wire, and time.



Controllers

Control Functions

Fast Processing Speed Stable and efficient processing

Basic instructions processing time: 1850µs/1000 steps. Fast processing time is available in the integrated control function.

10A Relay No external relay, reducing wiring

Max. 10A output enables direct operation of solenoid valves. No additional circuit necessary to connect a relay, reducing wiring.

Memory Large memory size enables stress-free programming of easy-to-see screen

Stress-free programming with large memory size - 47.4kB program size (when using ladder program. FBD: 38kB) and 5MB configuration memory capacity.

*1) System software version V4.05 or later (47.4kB with V4.04 or earlier)

USB Flash Drive Easy log data saving

Integrated data logging function using a USB memory. Programs can also be changed easily.

High Speed High-speed counter

Fast counter (single-phase 10 kHz/4 point, two-phase 5 kHz/1 point).

Structure

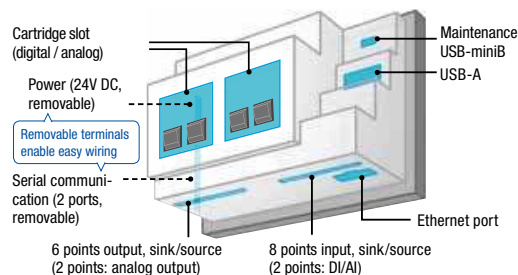

Display Functions

Color LCD 65,536-color high-resolution TFT LCD

Brightest LCD in its class. Compact screen with unparalleled visibility.



Mono-chrome Backlit with pink, red, or white colors

Check the system status easily with the super-bright display with pink, red, or white backlight. Displays the same level of brightness as the color LCD models.

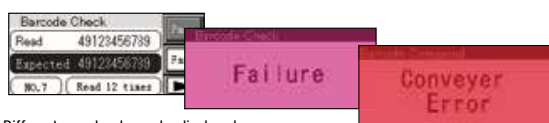

Different error levels can be displayed.

Fast start-up Stress-free, 3-second start-up

Fast start-up allows for easy debugging and stress-free operation.

32-level Brightness Adjustment LED backlight dimming control

The brightness of the backlight can be adjusted according to surrounding conditions (day/night), saving energy.

Rear Mount Adapter Flexible system design with rear mount adapter

An adapter to rear mount the Touch. Choose the most suitable mounting method to mount on the equipment.
(The customer should prepare the panel surface sheet and panel cut-out.)



When installed

- APEM
- Switches & Pilot Lights
- Control Boxes
- Emergency Stop Switches
- Enabling Switches
- Safety Products
- Explosion Proof
- Terminal Blocks
- Relays & Sockets
- Circuit Protectors
- Power Supplies
- LED Illumination
- Controllers
- Operator Interfaces
- Sensors
- AUTO-ID
- FC6A
- FT1A
- FL1F

Download catalogs and CAD from <http://eu.idec.com/downloads>

L-050

SmartAXIS Pro/Lite

Controls for various applications



APEM

Switches & Pilot Lights

Control Boxes

Emergency Stop Switches

Enabling Switches

Safety Products

Explosion Proof

Terminal Blocks

Relays & Sockets

Circuit Protectors

Power Supplies

LED Illumination

Controllers

Operator Interfaces

Sensors

AUTO-ID

F06A

FT1A

FL1F

Fast Processing Speed

Stable and efficient processing

Basic instructions processing time: 950µs/1000 steps

Memory

Large memory size for easy-to-see screen

Large program memory (12 I/O: 12 kB^{*1}, 24 I/O and up: 47.4 kB^{*2}) achieves reduction of development processes.

*1: When using ladder program. FBD: 10kB

*2: When using ladder program. FBD: 38kB

High Speed Counter

Positioning control possible with only one controller

Supports positioning control with a single-phase (100 kHz)/4 point or a single-phase (100 kHz)/two-phase (50 kHz)/2 point high-speed counter input. Ideal for easy positioning or motor control using a rotary encoder. Equipped with 6 points for interrupt input, catch input, and frequency input.

SD Memory Card

Easy log data saving

Data can be saved or transferred by using an SD memory card. Saved data can be read via Ethernet. Up to 64 data registers can be saved at the same time. Can store up to 4 data per second (depends on the program processing speed.)

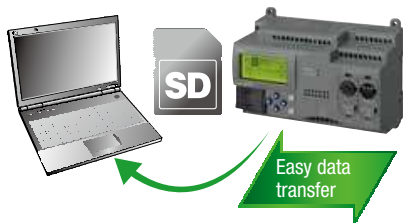

10A Relay

No external relay, reducing wiring

10A output relays connect directly to small motors and solenoid valves. No additional circuit necessary to connect a relay, reducing wiring.

Solenoid valve



High-speed Output

Built-in biaxial positioning function

Independent dual-axis control is performed using two pulse outputs. Locational values can be easily defined for precise position (trapezoidal) control.

Memory Cartridge

Easy maintenance, no PC required.

User programs can be read or written easily, reducing labor. When a memory cartridge is installed in the SmartAXIS, the user program stored in the memory cartridge is executed.

Structure

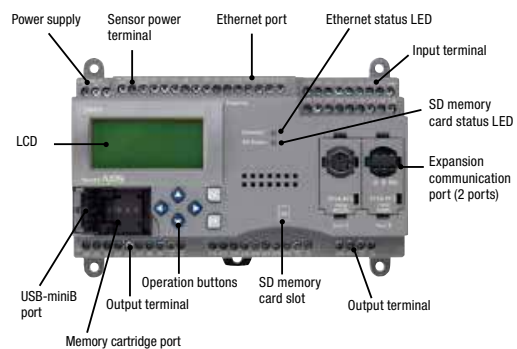

SmartAXIS Touch/Pro/Lite

I/O Monitor "I/O status monitor" screen for monitoring I/O status

The monitor screens on LCD show ON/OFF status of I/Os (Touch/Pro only), enabling quick I/O status monitoring when error occurs.



Ladder Monitor Easy troubleshooting

Easy ladder program monitoring using 4 buttons. Parameters on monitor screens can be checked and changed easily. (Touch/Pro only) (monitor function is not possible with FBD.)

Touch

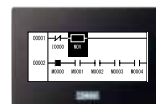

Pro



Inputs from the operation buttons can be programmed as digital inputs. No external device necessary for checking the programs.

Device Monitor Easy and quick program change

Parameters can be confirmed/checked using the device monitor function of Pro/Touch (monitoring FBD is not possible).

Touch



Pro



Online Monitor Easy set-up

Debugging is possible by connecting the SmartAXIS with WindLDR or WindO/I-N3.

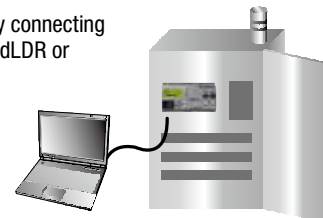

Clock Easy time schedule control using "Clock Function"

Clock function enables you to automatically control the time schedule for systems such as lighting or water sprinkler.

Ethernet Remote maintenance

The user program can be downloaded to/uploaded from the SmartAXIS at remote locations via Ethernet (except 12 I/O type of Pro/Lite).

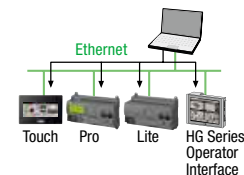

Efficiency Digital/analog (0 to 10V DC) compatible input

External analog potentiometer makes it easy to set the timer. Suitable for applications requiring a few analog inputs. (Pro/Lite: DC power model only)

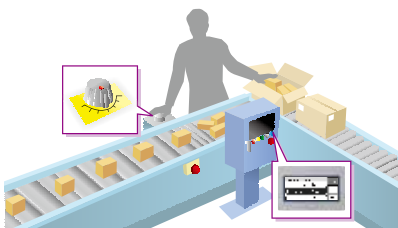

Front Panel Maintenance Easy data maintenance, shortening setup and adjustment time.

Using a panel mount extension cable, data can be transferred without opening the panel. Debugging of ladder program in the controller is also possible (Touch only).

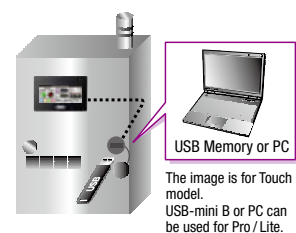

USB Memory or PC
The image is for Touch model. USB-mini B or PC can be used for Pro / Lite.

Security Password protection for secure system operation

Protect systems and programs using a password.



Operator Interface Connection to Operator Interface

Pro/Lite can be connected to IDEC's HG series operator interface for powerful expressivity and rich information.



Photo: HG3G Operator Interface

- APEM
- Switches & Pilot Lights
- Control Boxes
- Emergency Stop Switches
- Enabling Switches
- Safety Products
- Explosion Proof
- Terminal Blocks
- Relays & Sockets
- Circuit Protectors
- Power Supplies
- LED Illumination
- Controllers
- Operator Interfaces
- Sensors
- AUTO-ID

FC6A

FT1A

FL1F

Download catalogs and CAD from <http://eu.idec.com/downloads>

L-052

SmartAXIS Pro/Lite

Positioning Multistage Control

Independent dual-axis control is possible using two pulse outputs. Positioning (ramp-up/down control) can be achieved easily by setting the required values. (Pro/Lite pulse out put model only) ▶ For applicable models, see L-055 & L-056

Application example: PVC bag machine

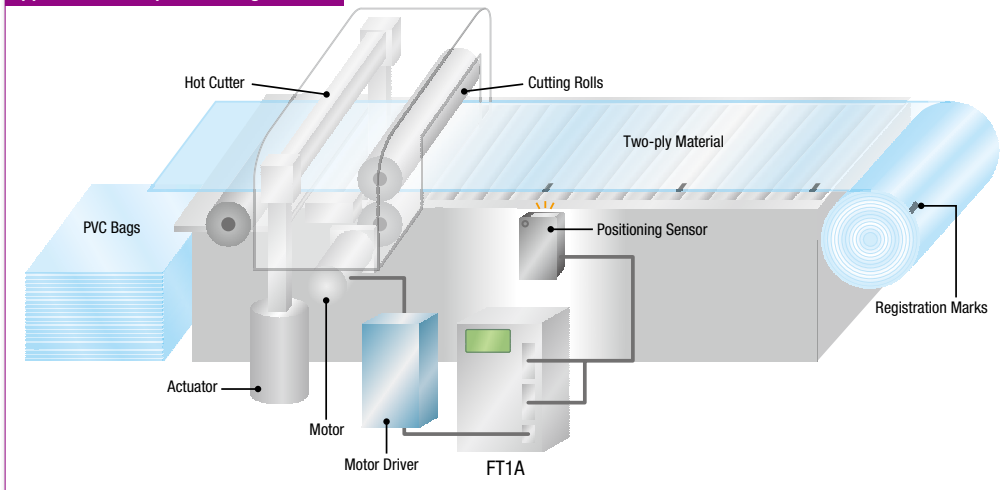

WindLDR: setting screen with preview

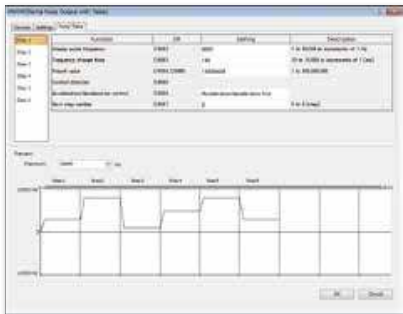

Target frequency change programmable for 18 steps maximum

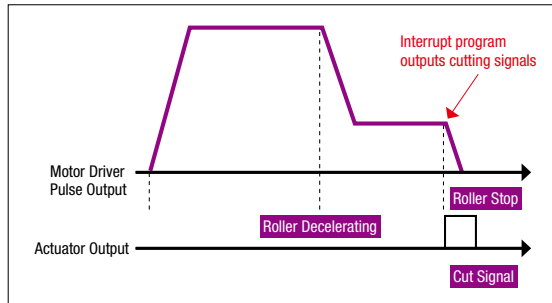

Various Application Examples

SmartAXIS is suitable for various applications.

Applications	Functions	10A Relay	Analog Input	Calendar	Pulse Output	Data Logging	Ethernet Communication	User Communication	USB Communication
Elevator Control		●			●				
Drain Pumps		●	●	●		●	●		
Water Server		●				●		●	
Coffee Server		●	●						
Vending Machine		●	●			●			
Sprinkler		●		●				●	
Mist Generator			●	●					
Greenhouse Control			●	●		●	●		
Coin-operated Shower		●	●			●			
Golf Ball Feeder					●	●			
System Status Collection						●	●		
Barcode Reader						●		●	●

SmartAXIS Network

Controllers

Various Networks for a Wide Variety of Applications

(Except for 12 I/O type of Pro/Lite)

User Communication

The user communication of the SmartAXIS enables you to control external devices such as PCs, printers, and barcode readers.

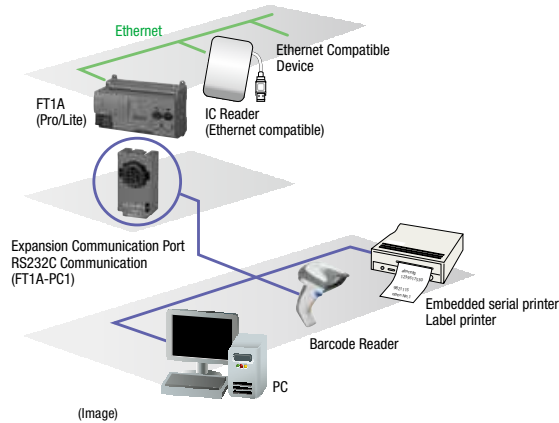

(Image)

Modbus RTU Communication

The SmartAXIS is compliant with Modbus protocol and can be used as either a Modbus communication master or slave. When used as a Modbus master, the SmartAXIS can monitor and modify data of Modbus compliant devices such as inverters and temperature controllers using Modbus communication (Touch can be used as a master only).

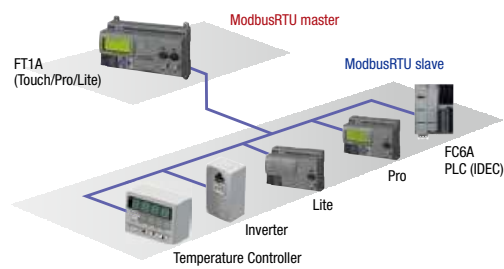

Modbus TCP

The SmartAXIS supports Modbus communications protocols. Modbus TCP protocol can also be used on the built-in Ethernet port, and can be used as a client (master) or server (slave), to monitor and change data of devices such as inverters and temperature controllers.

Note: When Pro/Lite is the client (master): up to 3 servers (slaves) can be connected. When Touch is the client (master): up to 16 servers (slaves) can be connected.

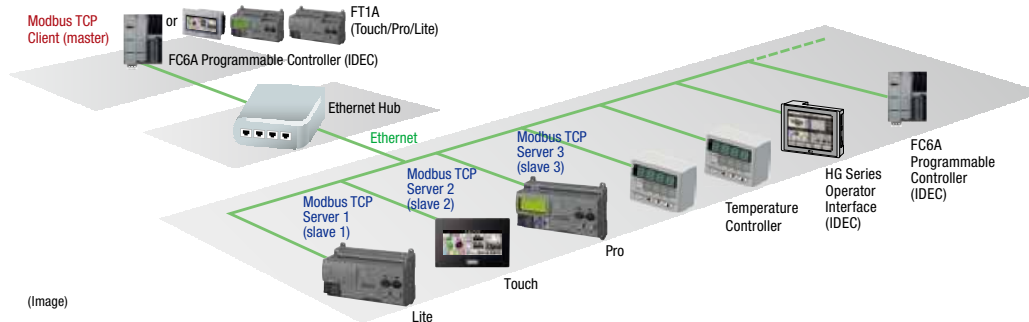

(Image)

Remote I/O

The remote I/O of the SmartAXIS enables you to expand the number of inputs and outputs by connecting separate SmartAXIS modules over Ethernet as remote I/O slaves. The total number of I/Os can be expanded up to 144 I/Os. The SmartAXIS remote I/O master can use the analog inputs on the remote I/O slaves (Pro/Lite only).

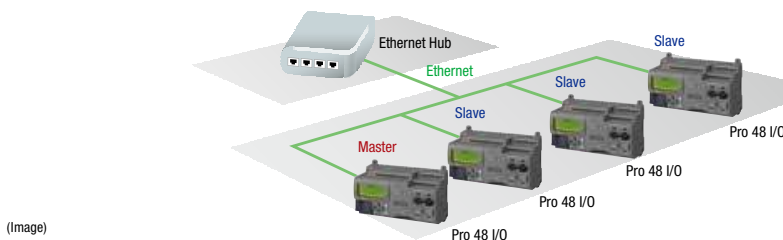

(Image)

 Download catalogs and CAD from <http://eu.idec.com/downloads>

- APEM
- Switches & Pilot Lights
- Control Boxes
- Emergency Stop Switches
- Enabling Switches
- Safety Products
- Explosion Proof
- Terminal Blocks
- Relays & Sockets
- Circuit Protectors
- Power Supplies
- LED Illumination
- Controllers**
- Operator Interfaces
- Sensors
- AUTO-ID

FC6A

FT1A

FL1F

L-054

SmartAXIS Selection Guide

Specifications		Touch			Pro								
		Color LCD	Monochrome LCD		12		24		40				
Part Number		FT1A- *12RA-□	FT1A- *14KA-□	FT1A- *14SA-□	FT1A- H12RA	FT1A- H12RC	FT1A- H24RA	FT1A- H24RC	FT1A- H40RKA	FT1A- H40RSA	FT1A- H40RC		
Power Voltage		24V DC			24V DC	100- 240V AC	24V DC	100- 240V AC	24V DC	24V DC	100- 240V AC		
I/O Points	No. of inputs	Digital	Sink 6 points	Source 6 points	Sink 6 points	6 points	8 points	12 points	16 points	18 points	18 points	24 points	
		Analog	2pt (0-10VDC, 10-bit Resolution)	2pt (0-10VDC, 10-bit Resolution)	4-20mA, 10-bit Resolution)	2 points	—	4 points	—	6 points	6 points	—	
	No. of outputs	Relay output	10A relay	4 points	—	—	4 points	4 points	4 points	4 points	4 points	4 points	4 points
			2A relay	—	—	—	—	—	4 points	4 points	8 points	8 points	12 points
		Transistor (sink output)	—	4 points	—	—	—	—	—	4 points	—	—	
Transistor (source output)	—	—	4 points	—	—	—	—	—	4 points	—			
Analog output		—	2 points	2 points	—	—	—	—	—	—	—		
Maximum Expansion I/O Points	Analog input/ Analog output (*6)		2/0 points	2/6 points 4/4 points 6/2 points	2/6 points 4/4 points 6/2 points	—	—	—	—	—	—		
	Program Capacity		94.8kB (23,700 steps equivalent) (*5) Configuration Memory Capacity: 5MB			12kB (3,000 steps equivalent)	47.4kB (11,850 steps equivalent)						
Ladder Program	Instructions Processing Time	Basic Instruction Time	1,850µs/1,000 steps			950µs/1,000 steps							
		END Processing	5ms minimum			2ms							
FBD	Program Capacity		Program Size: 38kB Configuration Memory Size: 5MB			10kB	38kB						
	Instructions Processing Time	Instruction Time	4ms/100 points			1.3ms/100 points							
		Scan End Processing	5ms minimum			2.5ms							
(Maximum Counter Frequency and Points)	Single/two-phase selectable		1 point (5kHz, 2/4-edge, no single-phase use)			2 points (*1)	—	2 points (*1)	—	2 points (*1)	—		
	Single-phase		4 points (×10kHz)			2 points (×100kHz)	—	4 points (×100kHz)	—	4 points (×100kHz)	—		
Pulse Output	100kHz		—			—		—		2 points	2 points	—	
	5kHz		—			—		—		2 points	2 points	—	
Interface	USB Port		2 (USB-A, USB-miniB) (*2)			1 (*2)	1 (*2)		1 (*2)				
	Ethernet		1			—		1		1			
	Expansion Communication Ports		—			—		1		2			
		RS232C		1			—		1 max. (*3)		2 max. (*3)		
		RS422/485		1			—		1 max. (*3)		2 max. (*3)		
	SD Memory Card		—			—		—		1 (*4)			
Memory Cartridge		—			1		1		1				
USB Memory		○			—		—		—				
Clock Function		○			○		○		○				
LCD		TFT color (65,536 colors) STN monochrome (pink/red/white backlight)			○ (STN monochrome)		○ (STN monochrome)		○ (STN monochrome)				

* LCD: M (STN monochrome), C (TFT color) □ Bezel color: W (light gray), B (dark gray), S (silver)

*1) Single-phase: 100kHz, two-phase: 50kHz, 2/4-edge



*3) When expansion communication cartridge is installed.

*5) Touch system software version V4.05 or later (47.4kB with V4.04 or earlier) (11,850 steps equivalent)

*2) USB-miniB (maintenance port)

*4) SD memory card: 32GB max.

*6) Depends on the cartridge combination.

Pro				Lite											
															
48				12		24		40				48			
FT1A-H48KA	FT1A-H48SA	FT1A-H48KC	FT1A-H48SC	FT1A-B12RA	FT1A-B12RC	FT1A-B24RA	FT1A-B24RC	FT1A-B40RKA	FT1A-B40RSA	FT1A-B40RC	FT1A-B48KA	FT1A-B48SA	FT1A-B48KC	FT1A-B48SC	
24V DC	24V DC	100-240V AC	100-240V AC	24V DC	100-240V AC	24V DC	100-240V AC	24V DC	24V DC	100-240V AC	24V DC	24V DC	100-240V AC	100-240V AC	
22 points	22 points	30 points	30 points	6 points	8 points	12 points	16 points	18 points	18 points	24 points	22 points	22 points	30 points	30 points	
8 points	8 points	—	—	2 points	—	4 points	—	6 points	6 points	—	8 points	8 points	—	—	
—	—	—	—	4 points	4 points	4 points	4 points	4 points	4 points	4 points	—	—	—	—	
—	—	—	—	—	—	4 points	4 points	8 points	8 points	12 points	—	—	—	—	
18 points	—	18 points	—	—	—	—	—	4 points	—	—	18 points	—	18 points	—	
—	18 points	—	18 points	—	—	—	—	—	4 points	—	—	18 points	—	18 points	
—	—	—	—	—	—	—	—	—	—	—	—	—	—	—	
—	—	—	—	—	—	—	—	—	—	—	—	—	—	—	
47.4kB (11,850 steps equivalent)				12kB (3,000 steps equivalent)				47.4kB (11,850 steps equivalent)							
950µs/1,000 steps				950µs/1,000 steps											
2ms				640µs											
38kB				10kB				38kB							
1.3ms/100 points				1.3ms/100 points											
2.5ms				1ms											
2 points (*1)		—		2 points (*1)		—		2 points (*1)		—		2 points (*1)		—	
4 points (×100kHz)		—		2 points (×100kHz)		—		4 points (×100kHz)		—		4 points (×100kHz)		—	
2 points	2 points	2 points	2 points	—				—				2 points	2 points	2 points	2 points
2 points	2 points	2 points	2 points	—				—				2 points	2 points	2 points	2 points
1 (*2)				1 (*2)		1 (*2)		1 (*2)				1 (*2)			
1				—		1		1				1			
2				—		1		2				2			
2 max. (*3)				—		1 max. (*3)		2 max. (*3)				2 max. (*3)			
2 max. (*3)				—		1 max. (*3)		2 max. (*3)				2 max. (*3)			
1 (*4)				—		—		1 (*4)				1 (*4)			
1				1		1		1				1			
—				—		—		—				—			
○				○		○		○				○			
○ (STN monochrome)				—		—		—				—			

- APEM
- Switches & Pilot Lights
- Control Boxes
- Emergency Stop Switches
- Enabling Switches
- Safety Products
- Explosion Proof
- Terminal Blocks
- Relays & Sockets
- Circuit Protectors
- Power Supplies
- LED Illumination
- Controllers**
- Operator Interfaces
- Sensors
- AUTO-ID

FC6A

FT1A

FL1F



Download catalogs and CAD from <http://eu.idec.com/downloads>

L-056

SmartAXIS Series FT1A Controller

FT1A

Touch (Display Models)

Package Quantity: 1

Type	Power	I/O	Input		Output	Program Size (ladder/FBD)	Interfaces	LCD	Bezel Color	Part No.
			Digital I/O	Analog I/O (*1)						
Relay Output	24V DC	12 points (8/4)	6 (sink) (24V DC)	2	4 points 10A relay output	Program size: 94.8 (*3)/38kB Configuration memory size: 5 MB	USB-A USB-mini B RS232C RS422/485 Ethernet	STN monochrome	Light gray	FT1A-M12RA-W
									Dark gray	FT1A-M12RA-B
									Silver	FT1A-M12RA-S
		TFT color	Light gray	FT1A-C12RA-W						
			Dark gray	FT1A-C12RA-B						
			Silver	FT1A-C12RA-S						
Transistor Output	24V DC	14 points (8/6)	6 (source) (24V DC)	2	4 points Tr. sink output 2 points analog output	Program size: 94.8 (*3)/38kB Configuration memory size: 5 MB	USB-A USB-mini B RS232C RS422/485 Ethernet	STN monochrome	Light gray	FT1A-M14KA-W
									Dark gray	FT1A-M14KA-B
			Silver	FT1A-M14KA-S						
			TFT color	Light gray	FT1A-M14SA-W					
				Dark gray	FT1A-M14SA-B					
				Silver	FT1A-M14SA-S					
TFT color	Light gray	FT1A-C14KA-W								
	Dark gray	FT1A-C14KA-B								
	Silver	FT1A-C14KA-S								
TFT color	Light gray	FT1A-C14SA-W								
	Dark gray	FT1A-C14SA-B								
	Silver	FT1A-C14SA-S								

Pro (LCD Models)

Package Quantity: 1

Power	I/O	Input		Output	High-Speed Tr. Output	Program Size (ladder/FBD)	Interfaces				Memory Cartridge	SD Memory Card	Part No.	
		Digital I/O	Analog I/O (*1)				USB mini-B Port	Ethernet Port	Expansion communication port (*2)					
									Port 2	Port 3				
24V DC	12 points (8/4)	24V DC Input	6	2	4 points 10A relay output	12/10 kB	○	○	○	○	○	○	FT1A-H12RA	
	24 points (16/8)		12	4	4 points 10A relay output 4 points 2A relay output								FT1A-H24RA	
	40 points (24/16)		18	6	4 points 10A relay output 8 points 2A relay output								4 points Tr. sink output 4 points Tr. source output	FT1A-H40RKA
	48 points (30/18)		22	8	18 points Tr. sink output 18 points Tr. source output								FT1A-H40RSA	
100 to 240V AC	12 points (8/4)	24V DC Input	8	—	4 points 10A relay output	12/10 kB	○	○	○	○	○	○	FT1A-H48KA	
	24 points (16/8)		16	—	4 points 10A relay output 4 points 2A relay output								FT1A-H48SA	
	40 points (24/16)		24	—	4 points 10A relay output 12 points 2A relay output								FT1A-H12RC	
	48 points (30/18)		30	—	18 points Tr. sink output 18 points Tr. source output								FT1A-H24RC	
													FT1A-H40RC	
													FT1A-H48KC	
													FT1A-H48SC	

Lite (No LCD Models)

Package Quantity: 1

Power	I/O	Input		Output	High-Speed Tr. Output	Program Size (ladder/FBD)	Interfaces				Memory Cartridge	SD Memory Card	Part No.	
		Digital I/O	Analog I/O (*1)				USB mini-B Port	Ethernet Port	Expansion communication port (*2)					
									Port 2	Port 3				
24V DC	12 points (8/4)	24V DC Input	6	2	4 points 10A relay output	12/10 kB	○	○	○	○	○	○	FT1A-B12RA	
	24 points (16/8)		12	4	4 points 10A relay output 4 points 2A relay output								FT1A-B24RA	
	40 points (24/16)		18	6	4 points 10A relay output 8 points 2A relay output								4 points Tr. sink output 4 points Tr. source output	FT1A-B40RKA
	48 points (30/18)		22	8	18 points Tr. sink output 18 points Tr. source output								FT1A-B40RSA	
100 to 240V AC	12 points (8/4)	24V DC Input	8	—	4 points 10A relay output	12/10 kB	○	○	○	○	○	○	FT1A-B48KA	
	24 points (16/8)		16	—	4 points 10A relay output 4 points 2A relay output								FT1A-B48SA	
	40 points (24/16)		24	—	4 points 10A relay output 12 points 2A relay output								FT1A-B12RC	
	48 points (30/18)		30	—	18 points Tr. sink output 18 points Tr. source output								FT1A-B24RC	
													FT1A-B40RC	
													FT1A-B48KC	
													FT1A-B48SC	

*1) Digital/analog-compatible input

*2) The following communication cartridges can be connected.

FT1A-PC1: RS232C, mini-DIN type, FT1A-PC2: RS485, mini-DIN type, FT1A-PC3: RS485, terminal block type

*3) Touch system software version V4.05 or later (47.4KB with V4.04 or earlier).

Options / Maintenance Parts

Options

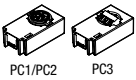
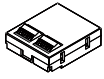
Name/Appearance	Applicable Model			Part No. (Ordering No.)	Package Quantity	Specifications
	Touch	Pro	Lite			
Application software	○	○	○	SW1A-W1C	1	Automation Organizer Ver. 2.0 or higher (*1)
USB maintenance cable	○	○	○	HG9Z-XCM42	1	USB cable (length 2 m), USB-miniB
Panel mount extension cable	○	—	—	HG9Z-XCE11	1	USB-A port extension cable (length 1 m)
	○	○	○	HG9Z-XCE21	1	USB-mini B port extension cable (length 1 m)
Screen protection sheet (*2)	○	—	—	FT9Z-1D3PN05	5	
Protective cover	○	—	—	FT9Z-1E3PN05	5	
Memory card	—	○	○	HG9Z-XMS2	1	SD memory card (2 GB)
Memory cartridge	—	○	○	FT1A-PM1	1	Dedicated user program save memory (1 MB)
Communication cartridge 	—	○	○	FT1A-PC1	1	RS232C, mini-DIN type
	—	○	○	FT1A-PC2	1	RS485, mini-DIN type
	—	○	○	FT1A-PC3	1	RS485, terminal block type
Digital I/O Cartridge	Digital Input	○	—	FC6A-PN4	1	4 (4/1 common)
	Digital Output	○	—	FC6A-PTK4	1	4 sink (4/1 common)
		○	—	FC6A-PTS4	1	4 source (4/1 common)
Analog cartridge 	○	—	—	FC6A-PJ2A	1	Voltage/current input (2 points)
	○	—	—	FC6A-PK2AV	1	Voltage output (2 points)
	○	—	—	FC6A-PK2AW	1	Current output (2 points)
	○	—	—	FC6A-PJ2CP	1	Temperature input (2 points)
	○	—	—			
Rear mount adapter	○	—	—	FT9Z-1A01	1	Rear mount bracket
35-mm-wide DIN Rail	—	○	○	BAA1000PN10	10	See H-071 for details on DIN rail products.
	—	○	○	BAP1000PN10	10	
DIN rail end clip	—	○	○	BNL6PN10	10	
Touch User's Manual	Japanese	○	—	FT9Y-B1389	1	
	English	○	—	FT9Y-B1390	1	
Pro/Lite User's Manual	Japanese	—	○	FT9Y-B1377	1	
	English	—	○	FT9Y-B1378	1	
SmartAXIS Ladder Programming Manual	Japanese	○	○	FT9Y-B1381	1	
	English	○	○	FT9Y-B1382	1	
FBD Programming Manual	Japanese	○	○	FT9Y-B1385	1	
	English	○	○	FT9Y-B1386	1	

*1) Upgrade from earlier version is possible on IDEC website. The following manuals in PDF can be downloaded from <http://www.idec.com/language>.

- FT1A SmartAXIS Touch User's Manual (English, Japanese, Simplified Chinese)
- FT1A SmartAXIS Pro/Lite User's Manual (English, German, Japanese, Simplified Chinese)
- FT1A SmartAXIS Ladder Programming Manual (English, German, Japanese, Simplified Chinese)
- FT1A SmartAXIS FBD Programming Manual (English, German, Japanese, Simplified Chinese)

*2) UV resistance material is used. However, resistance against direct sunlight in outdoor usage is not guaranteed.





*3) Use commercially-available USB memory to store project data, log data, and recipe file of Touch models.

*4) Can be used for 40-I/O and 48-I/O types. Note that user programs cannot be stored or read using an SD memory card. If necessary, use a memory cartridge.

*5) Cannot be used for expansion with 12-I/O type.

*6) Cannot be used for expansion with relay output type.

Maintenance Parts

Name	Applicable Model (*1)			Part No. (Ordering No.)	Package Quantity	Specification
	Touch	Pro	Lite			
Communication Interface plug 	○	—	—	FT9Z-1T09	1	For communication ports (black) One supplied with Touch
Power supply plug 	○	—	—	FT9Z-1X03	1	For power supply terminals (black) One supplied with Touch
Mounting bracket 	○	—	—	HG9Z-4K2PN04	4	Two sets Two supplied with Touch
USB cable lock pin 	○	—	—	HG9Z-XU1PN05	5	Used when using the USB cable on a regular basis Two supplied with Touch
Direct mounting hook 	—	○	○	FT9Z-PSP1PN05	5	Direct mounting hook for Pro/Lite One set supplied with Pro/Lite

*1) Supplied with FT1A.

 Download catalogs and CAD from <http://eu.idec.com/downloads>

L-058

FT1A Controllers

General Specifications

Touch (Display Model)

Part No.	FT1A-*12RA-*	FT1A-*14KA-* / FT1A-*14SA-*
Output	Relay output	Transistor output
Rated Power Voltage/ Power Supply Isolation	24V DC/Not isolated	
Allowable Voltage Range	20.4 to 28.8V DC (including ripple)	
Power Consumption	9.2W maximum	11W maximum
Allowable Momentary Power Interruption	10 ms maximum	
Dielectric Strength	1. Between power terminal and FE terminal: 500V AC, 5 mA, 1 minute 2. Between power terminal and output terminal: 2,300V AC, 5 mA, 1 minute	1. Between power terminal and FE terminal: 500V AC, 5 mA, 1 minute 2. Between power terminal and output terminal: 500V AC, 5 mA, 1 minute
EMC Immunity	IEC/EN 61131-2:2007 compliant	
Inrush Current	50A maximum (5ms maximum)	
Operating Temperature	Color display: -20 to +55°C, Monochrome display: 0 to +55°C (*1) (*2)	
Storage Temperature	-20 to +60°C (no freezing)	
Relative Humidity	10 to 95% RH (no condensation)	
Pollution Degree	2 (IEC 60664-1)	
Corrosion Immunity	Atmosphere free from corrosive gases	
Degree of Protection	IP66F TYPE 4X TYPE 13 (Panel front) (*3), IP20 (Rear)	
Ground	Functional grounding	
Protective grounding conductor	UL1007 AWG16	
Vibration Resistance	5 to 8.4 Hz half amplitude 3.5 mm, 8.4 to 150 Hz, acceleration 9.8 m/s ² (1G), 2 hours per axis on each of three mutually perpendicular axis (IEC 61131-2)	
Shock Resistance	147 m/s ² , 11 ms, X, Y, Z directions 3 times (IEC 61131-2)	
Mounting Structure	Panel mount	
Weight (approx.)	300g	250g

*1) FT1A-*12RA-* hardware version V130 (indicated on hardware) and earlier is UL, c-UL listed at 50°C (maximum operating temperature).

*2) See SmartAXIS Touch User's Manual FT9Y-B1390(2) for I/O derating.

*3) Operation not guaranteed when used with certain types of oils.

Pro/Lite (LCD Model/No LCD Model)

Part No.	Pro/Lite										
	12-I/O Type		24-I/O Type		40-I/O Type		48-I/O Type				
	H12RA	H12RC	H24RA	H24RC	H40RKA	H40RSA	H40RC	H48KA	H48SA	H48KC	H48SC
	B12RA	B12RC	B24RA	B24RC	B40RKA	B40RSA	B40RC	B48KA	B48SA	B48KC	B48SC
Rated Power Voltage/Power Supply Isolation	AC power: 100 to 240V AC/Isolation with transformer DC power: 24V DC/Not isolated										
Allowable Voltage Range	AC power: 85 to 264V AC DC power: 20.4 to 28.8V DC (including ripple)										
Rated Power Frequency	AC power: 50 to 60 Hz (47 to 63 Hz)										
Power Consumption	AC power	12-I/O: 18 VA maximum, 24-I/O: 41 VA maximum, 40-I/O: 48VA maximum, 48-I/O: 43 VA maximum									
	DC power	12-I/O: 4.3W maximum, 24-I/O: 4.8W maximum, 40-I/O: 7.9W maximum, 48-I/O: 6.0W maximum									
Allowable Momentary Power Interruption	AC power: 20 ms maximum, DC power: 10 ms maximum										
Dielectric Strength	AC power type: Between power/input and PE terminals: 1,500V AC, 5mA, 1 minute Between transistor output and PE terminals: 1,500V AC, 5mA, 1 minute Between relay output and PE terminals: 2,300V AC, 5mA, 1 minute Between power and input terminals: 1,500V AC, 5mA, 1 minute Between power/input and transistor output terminals: 1,500V AC, 5mA, 1 minute Between power/input and relay output terminals: 2,300V AC, 5mA, 1 minute										
	DC power type: Between power/input and FE terminals: 500V AC, 5mA, 1 minute Between transistor output and FE terminals: 500V AC, 5mA, 1 minute Between relay output and FE terminals: 2,300V AC, 5mA, 1 minute Between power/input and transistor output terminals: 500V AC, 5mA, 1 minute Between power/input and relay output terminals: 2,300V AC, 5mA, 1 minute										
EMC Immunity	IEC/EN 61131-2:2007 compliant										
Inrush Current	AC power: 35A maximum (Cold start with Ta=25°C, 200V AC) DC power: 30A maximum (5ms maximum)										
Operating Temperature	0 to +55°C (*1)										
Storage Temperature	-25 to +70°C (no freezing)										
Relative Humidity	10 to 95% RH (no condensation)										
Pollution Degree	2 (IEC 60664-1)										
Corrosion Immunity	Atmosphere free from corrosive gases										
Degree of Protection	IP20 (IEC 60529)										
Ground	D-type ground (Class 3 ground)										
Protective grounding conductor	UL1007 AWG16										
Vibration Resistance	5 to 8.4 Hz half amplitude 3.5 mm, 8.4 to 150 Hz, acceleration 9.8 m/s ² (1G), 2 hours per axis on each of three mutually perpendicular axis (IEC 61131-2)										
Shock Resistance	147 m/s ² , 11 ms, X, Y, Z directions 3 times (IEC 61131-2)										
Mounting Structure	DIN rail or direct mount										
Weight (approx.)	AC power	12-I/O: 230g, 24-I/O: 400g, 40-I/O: 580g, 48-I/O: 540g									
	DC power	12-I/O: 190g, 24-I/O: 310g, 40-I/O: 420g, 48-I/O: 380g									

*1) Hardware version V110 (indicated on hardware) is UL, c-UL Listed at 50°C (maximum operating temperature).

Function Specifications (Touch)

Part No.		Touch			
		FT1A-*12RA-*	FT1A-*14KA-*	FT1A-*14SA-*	
Control System		Stored program system			
Ladder Program	Instruction Words	Basic Instructions		42 types	
		Advanced Instructions		98 types	
				99 types	
Program Capacity		Program size: 94.8kB (23,700 steps equivalent) (*4), Configuration memory capacity: 5 MB			
Processing Time	Basic Instruction	1850µs/1,000 steps			
	END Processing	5 msec minimum			
FBD	FB	37 types			
	Program Capacity		Program size: 38kB, configuration memory capacity: 5MB		
	No. of FB	FB (*1)	1,000		
		Timer (T)	200		
		Counter (C)	200		
Processing Time	Basic Instruction	4ms/100			
	END Processing	5ms minimum			
User Program Storage		Flash ROM (100,000 times)			
I/O Points (*3)	Inputs	8 (90 max. can be added with remote I/O master function)	8 (90 max. can be added with remote I/O master function)		
	Outputs	4 (54 max. can be added with remote I/O master function)	4 (54 max. can be added with remote I/O master function)		
Analog Input (*3)		2 (24 max. can be added with remote I/O master function)	2 (4 max. can be added with analog cartridge, and 24 max. can be added with remote master function)		
Analog Output		—			
Internal Relays		1,024			
Shift Registers		128			
Data Registers		2000			
Special Data Registers		200			
Counters		200			
Timer (1ms, 10 ms, 100 ms, 1s)		200			
Clock		Precision: ±30 seconds/month (25°C, typical)			
RAM Backup	Backup Data	Internal relays, shift registers, counters, data registers, clock data			
	Backup Duration	Approximately 30 days (typical) at 25°C after backup battery is fully charged			
	Battery	Lithium secondary battery			
	Charging Time	Approximately 15 hours required to charge from 0 to 90%			
	Replaceability	Not possible			
Self-Diagnostic Functions		Keep data check, power failure check, watchdog timer check, timer/counter preset value change error check, user program syntax check, user program execution check			
Input Filter		No filter, 3 to 15 ms (selectable in increments of 1 ms)			
Catch Input/Interrupt Input		4/4			
High-speed Counter	Maximum Counting Frequency and Points	Single/two-phase selectable	1 (5 kHz, multiple 2/4, single-phase cannot be used)		
		Single-phase	4 (x 10 kHz)		
	Counting Range		0 to 4,294,967,295 (32 bits)		
	Operation Mode		Rotary encoder mode and adding counter mode		
Analog Voltage Inputs	Built-in Points		2		
	Input Range		0 to 10V DC	0 to 10V DC (voltage input) / 4 to 20 mA (current input)	
	Input Impedance		78 kΩ	78 kΩ (voltage input) / 250 Ω (current input)	
	Digital Resolution		0 to 1,000 (10 bits)		
Number of Relay Outputs		10A relay: 4			
Number of Transistor Outputs		—	4 (sink)	4 (source)	
Analog Output	Built-in Points		—		
	Output Range		—		
	Digital Resolution		0 to 10V DC (voltage output) / 4 to 20 mA (current output)		
Pulse Outputs	100 kHz	No. of outputs	—		
		Function	—		
	5 kHz	No. of outputs	—		
		Function	—		
External Output Power Supply for Sensor	Output Voltage		—		
	Output Current		—		
	Overload Detection		—		
	Insulation		—		
USB-mini B (*2)		○			
USB-A (*2)		○			
RS232C (*2)		○			
RS485/422 (*2)		○			
Ethernet		○			
Expansion Communication Ports	Port 2	—			
	Port 3	—			
Memory Cartridge		—			
SD Memory Card		—			
Analog Cartridge Interface	Number of Ports	—			
	Connectable Cards	—	2		
		—	4 (FC6A-PJ2A, FC6A-PK2AV, FC6A-PK2AW, FC6A-PJ2CP)		

*1) Except for timer, counter, input FB, and output FB.
 *3) FT1A-*12RA-*: system software V3.90 or later

*2) Not isolated from internal circuits.
 *4) Touch system software version V4.05 or later (47.4KB with V4.04 or earlier)

- APEM
- Switches & Pilot Lights
- Control Boxes
- Emergency Stop Switches
- Enabling Switches
- Safety Products
- Explosion Proof
- Terminal Blocks
- Relays & Sockets
- Circuit Protectors
- Power Supplies
- LED Illumination
- Controllers
- Operator Interfaces
- Sensors
- AUTO-ID
- FC6A
- FT1A
- FL1F

[Download catalogs and CAD from http://eu.idec.com/downloads](http://eu.idec.com/downloads)

FT1A Controllers

Function Specifications (Pro/Lite)

Part No.		Pro/Lite FT1A-								
		H12RA B12RA	H12RC B12RC	H24RA B24RA	H24RC B24RC	H40RKA H40RSA B40RKA B40RSA	H40RC B40RC	H48KA H48SA B48KA B48SA	H48KC H48SC B48KC B48SC	
Control System		Stored program system								
APEM	Instruction Words	Basic Instructions	42 types							
		Advanced Instructions	99 types	98 types	103 types	102 types	110 types	104 types	110 types	109 types
Switches & Pilot Lights	Program Capacity		12 kB (3000 steps equivalent)		47.4 kB (11,850 steps equivalent)					
Control Boxes	Processing Time	Basic Instruction	950 µs/1,000 steps							
		END Processing	2 ms (Pro) / 640 µs (Lite)							
Emergency Stop Switches	FB	FB	38 types	37 types	38 types	37 types	45 types	39 types	45 types	44 types
		Program Capacity	10kB		38kB					
Enabling Switches	No. of FB	FB (*1)	200		1,000					
		Timer (T)	100		200					
Safety Products	Counter (C)	Counter (C)	100		200					
		Processing Time	Basic Instruction		1.3ms/100					
Explosion Proof	Timer (1ms, 10 ms, 10 ms, 1s)	Basic Instruction	2.5ms (Pro)/1ms (Lite)							
		END Processing								
Terminal Blocks	User Program Storage		Flash ROM (10,000 times)							
Relays & Sockets	I/O Points	Inputs	8		16		24		30	
		Outputs	4		8		16		18	
Circuit Protectors	Internal Relays		256		1,024					
	Shift Registers		128		128					
Power Supplies	Data Registers		400		2000					
	Special Data Registers		200		200					
LED Illumination	Adding/Reversible Counters		100		200					
	Timer (1ms, 10 ms, 10 ms, 1s)		100		200					
Controllers	Clock		Precision: ±30 seconds/month (25°C, typical)							
Operator Interfaces	RAM Backup	Backup Data	Internal relays, shift registers, counters, data registers, clock data							
		Backup Duration	Approximately 30 days (typical) at 25°C after backup battery is fully charged							
Sensors	Charging Time	Battery	Lithium secondary battery							
		Replaceability	Approximately 15 hours required to charge from 0 to 90%							
AUTO-ID	Self-Diagnostic Functions		Keep data check, power failure check, clock error check, watchdog timer check, timer/counter preset value change error check, user program syntax check, user program execution check, system error check, memory cartridge transfer error check							
FC6A	High-speed Counter	Input Filter	No filter, 3 to 15 ms (selectable in increments of 1 ms)							
		Catch Input/Interrupt Input	4/4		6/6					
FT1A	Maximum Counting Frequency and Points	Single/two-phase selectable	2 (*2)	—	2 (*2)	—	2 (*2)	—	2 (*2)	—
		Single-phase	2 (x 100 kHz)	—	4 (x 100 kHz)	—	4 (x 100 kHz)	—	4 (x 100 kHz)	—
FL1F	Counting Range	Counting Range	0 to 4,294,967,295 (32 bits)							
		Operation Mode	Rotary encoder mode and adding counter mode							
Analog Voltage Inputs	Points	Points	2	None	4	None	6	None	8	None
		Input Range	0 to 10V DC							
		Input Impedance	78 kΩ							
		Digital Resolution	0 to 1,000 (10 bits)							
Pulse Outputs	100 kHz	No. of outputs	—	—	—	—	2	—	—	2
		Function	—	—	—	—	(*3)	—	—	(*3)
	5 kHz	No. of outputs	—	—	—	—	2	—	—	2
		Function	—	—	—	—	(*4)	—	—	(*4)
External Output Power Supply for Sensor	Output Voltage	Output Voltage	—	—	—	24V DC (+10%, -15%)	—	24V DC (+10%, -15%)	—	24V DC (+10%, -15%)
		Output Current	—	—	—	250 mA	—	300 mA	—	300 mA
		Overload Detection	—	—	—	Impossible	—	Impossible	—	Impossible
		Insulation	—	—	—	Internal Circuit	—	Internal Circuit	—	Internal Circuit
USB-mini B (*5)		○		○		○		○		
USB-A (*5)		—		—		—		—		
RS232C (*5)		—		○ (*6)		○ (*6)		○ (*6)		
RS485 (*5)		—		○ (*6)		○ (*6)		○ (*6)		
Ethernet		—		○		○		○		
Expansion Communication Ports	Port 2	—		○		○		○		
	Port 3	—		—		○		○		
Memory Cartridge		○		○		○		○		
SD Memory Card		—		—		○ (*7)		○ (*7)		

*1) Except for timer, counter, input FB, and output FB.

*2) 100 kHz when single-phase, 50 kHz when two-phase, multiple 2.4

*3) Pulse [PULS], Pulse without modulation [PWM], Ramp [RAMP, ARAMP], Zero return [ZRN]

*4) Pulse [PULS], Pulse without modulation [PWM]

*5) Not isolated from internal circuits.

*6) When communication cartridge is installed.

*7) The maximum capacity is 32 GB. DLOG/FB and TRACE/FB instructions are used to write data. For details, see L-071 to L-073.

Display Specifications

Touch/Pro (Display Model/Built-in LCD)

Part No.	Touch	Pro
Display Element	TFT color LCD	STN monochrome LCD
Colors/Shades	65,536 colors	Monochrome 8 shades
Effective Display Area	88.92 W x 37.05 H mm	87.59 W x 35.49 H mm
Display Resolution	240 W x 100 H pixels	192 W x 64 H pixels
View Angle	Left/right 40°, top 20°, bottom 60°	Left/right/top/bottom: 45°
Contrast Adjustment	Not possible	32 levels
Backlight	LED	LED (green)
Backlight Life	50,000 hours (Note 1)	—
Brightness	400 cd/m ² (Note 2)	740 cd/m ² (Note 2)
Brightness Adjustment	32 levels	Not possible
Backlight Control	Auto off function	On/off
Backlight Replacement	Not possible	—
Display Character Size	1/4 Size	8 x 8 pixels [JIS 8-bit code, ISO 8859-1 (Western European languages), ANSI 1250 (central Europe)], ANSI 1257 (Baltic), ANSI 1251 (Cyrillic)
	1/2 Size	8 x 16 pixels [JIS 8-bit code, ISO 8859-1 (Western European languages), ANSI 1250 (central Europe), ANSI 1257 (Baltic), ANSI 1251 (Cyrillic)]
		16 x 32 pixels, 24 x 48 pixels, 32 x 64 pixels (Western European languages: ISO 8859-1)
	Full Size	16 x 16 pixels (Japanese JIS first and second level characters, simplified Chinese, traditional Chinese, Korean)
Double Size	32 x 32 pixels (Japanese JIS first level characters, Mincho font)	
No of Characters	1/4 Size	30 characters x 12 lines/screen
	1/2 Size	30 characters x 6 lines/screen
	Full Size	15 characters x 6 lines/screen
	Double Size	7 characters x 3 lines/screen
Character Magnification	0.5x, 1x, 2x, 3x, 4x, 5x, 6x, 7x, 8x vertically and horizontally	—
Character Attributes	Blink, reverse, bold, shadowed (blink is 1 sec or 0.5 sec)	Blink, reverse
Graphics	Line, polyline, polygon, rectangle, circle, ellipse, arc, pie, equilateral polygons (3, 4, 5, 6, 8), fill, picture	—
Window Display	3 popup screens + 1 system screen	—

Note 1: The backlight life refers to the time until the brightness reduces by half after use at 25°C.
 Note 2: Brightness of LCD only (monochrome LCD: when lit white).

Operation Specifications

Touch/Pro (Display/LCD Models)

Part No.	Touch	Pro
Switching Element	Analog resistive membrane (touch panel)	Rubber switches
Operating Force	0.2 to 2.5N	2.0 N minimum
Mechanical Life	1 million operations	10,000 operations
Acknowledgment Sound	Electric Buzzer	Not provided
Multiple Press	Not possible	Possible

HMI Function Specifications (Touch)

Functions	Drawings, bit button, word button, goto screen button, key button, multi-button, keypad, selector switch, potentiometer, numerical input, character input, pilot lamp, picture display, message display, message switching display, alarm list display, alarm log display, numerical display, bar chart, line chart, pie chart, meter, calendar, bit write command, word write command, goto screen command, timer, script command, multi-command, system area, start time, Auto Backlight OFF, O/I Link, user communication, maintenance communication, DM Link Communication, PLC Link Communication (Note 1), alarm log, data log, operation log, data storage area, preventive maintenance, recipe, text group, global script, user account, project data transfer using external memory, downloading logged data in external memory, USB auto-run function
-----------	---

Note 1: The up-to-date information on the connectable PLC can be obtained from <http://www.idec.com/language>.



Download catalogs and CAD from <http://eu.idec.com/downloads>

L-062

FT1A Controllers

Input Specifications (Touch/Pro/Lite)

Part No.	Touch FT1A-			Pro/Lite FT1A-												
	12RA-	*14KA-*	*14SA-*	H12RA B12RA	H12RC B12RA	H24RA B24RA	H24RC B24RC	H40RKA B40RKA	H40RSA B40RSA	H40RC B40RC	H48KA B48KA	H48SA B48SA	H48KC B48KC	H48SC B48SC		
<p>APEM</p> <p>Switches & Pilot Lights</p> <p>Control Boxes</p> <p>Emergency Stop Switches</p> <p>Enabling Switches</p> <p>Safety Products</p> <p>Explosion Proof</p> <p>Terminal Blocks</p> <p>Relays & Sockets</p> <p>Circuit Protectors</p> <p>Power Supplies</p> <p>LED Illumination</p> <p>Controllers</p> <p>Operator Interfaces</p> <p>Sensors</p> <p>AUTO-ID</p> <p>FC6A</p> <p>FT1A</p> <p>FL1F</p>	<p style="writing-mode: vertical-rl; transform: rotate(180deg);">Input Specification</p>	Input Points	6			6	8	12	16	18	24	22	30			
		Input Type	Sink	Source	Sink	Sink	No-voltage (with contact)	Sink	Sink/Source	Source	Sink	Sink/Source	Source	Sink	Sink/Source	
		Input Voltage Range	0 to 28.8V DC													
		Rated Input Current	4.4 mA	5.2 mA	4.4 mA	No-voltage type and sink/source type: 5.3 mA, sink type: 4.4 mA, source type: 5.2 mA										
		Input Impedance	5.5 kΩ	4.7 kΩ	5.5 kΩ	No-voltage type and sink/source type: 4.3 kΩ, sink type: 5.5 kΩ, source type: 4.7 kΩ										
		Input Delay Time	OFF → ON	2.5 μs + soft filter setting			40 μs + filter value (high-speed input section: 2.5 μs + soft filter value)									
			ON → OFF	5 μs + soft filter setting			150 μs + filter value (high-speed input section: 5 μs + soft filter value)									
		Isolation	Between input terminals	Not isolated			Not isolated									
			Internal circuit	Not isolated			No-voltage type and sink/source type: optocoupler isolated, sink type and source type: not isolated									
		Input Type	Type 1 (IEC 61131-2)													
		External Load for I/O Interconnection	Not needed													
		Operating Level	OFF voltage	Sink type: 5V DC max. Source type: 15V DC min.			No-voltage type: 18 kΩ min., sink/source type and sink type: 5 VDC max., source type: 15 VDC min.									
			ON voltage	Sink type: 15V DC min. Source type: 5V DC max.			No-voltage type: 2 kΩ max., sink/source type and sink type: 15 VDC min., source type: 5 VDC max.									
			OFF current	Sink type: 0.9 mA max. Source type: -1.0 mA min.			No-voltage type and sink/source type: 1.1 mA max., sink type: 0.9 mA max., source type: -1.0 mA min.									
			ON current	Sink type: 2.7 mA min. Source type: -3.0 mA max.			No-voltage type and sink/source type: 3.0 mA min., sink type: 2.7 mA min., source type: -3.0 mA max.									
Analog Input	Input Points	2		2	4	6	8									
	Input Type	Voltage input	Voltage/Current input	Voltage input	Voltage input	Voltage input	Voltage input									
	Input Range	0 to 10.0 VDC	0 to 10.0 VDC / 4 to 20 mA	0 to 10.0V DC	0 to 10.0V DC	0 to 10.0V DC	0 to 10.0V DC									
	Sampling Duration Time	2 ms maximum		2 ms maximum	2 ms maximum	2 ms maximum	2 ms maximum									
	Total Input System Transfer Time	3 ms + sampling time + scan time	3 ms + sampling time + scan time (voltage input)	2 ms + filtering time + scan time	2 ms + filtering time + scan time	2 ms + filtering time + scan time	2 ms + filtering time + scan time									
		12 ms + sampling time + scan time (current input)														
	Digital Resolution	0 to 1,000 (10 bits)		0 to 1,000 (10 bits)	0 to 1,000 (10 bits)	0 to 1,000 (10 bits)	0 to 1,000 (10 bits)									
	Input Error	25°C	±3% of full scale		±1.5% of full scale	±1.5% of full scale	±1.5% of full scale									
		Total	±5% of full scale		±5% of full scale	±5% of full scale	±5% of full scale									
	Isolation	Between input terminals	Not isolated		Not isolated	Not isolated	Not isolated									
Internal circuit		Not isolated		Not isolated	Not isolated	Not isolated										
When used as digital input	Digital I/O	Type 1 (not conforming to IEC 61131-2 digital I/O type)														
	Operation Level	OFF voltage: 5V maximum														
		ON voltage: 15V minimum														
		OFF current: 0.06 mA maximum														
ON current: 0.20 mA minimum																
External Power for Input	Input Voltage Range	—		—	—	20.4 to 26.4V DC	—	20.4 to 26.4V DC	—	—	20.4 to 26.4V DC					
	Output Current Capacity	—		—	—	250 mA	—	300 mA	—	300 mA						

Output Specifications (Touch/Pro/Lite)

Part No.	Touch FT1A-			Pro/Lite FT1A-											
	*12RA-**	*14KA-**	*14SA-**	H12RA B12RA	H12RC B12RC	H24RA B24RA	H24RC B24RC	H40RKA B40RKA	H40RSA B40RSA	H40RC B40RC	H48KC B48KC	H48SC B48SC	H48KA B48KA	H48SA B48SA	
Transistor Output	Output Points	4	—	—	—	—	—	4	—	—	18	—	18	—	
	Transistor Sink Output	—	—	—	—	—	—	—	—	—	—	18	—	—	
	Transistor Source Output	—	4	—	—	—	—	—	4	—	—	—	—	18	
	Rated Load Voltage	24V DC			—			24V DC			24V DC				
	Input Voltage Range	20.4 to 28.8V DC			—			20.4 to 28.8V DC			20.4 to 28.8V DC				
	Maximum Load Current	1 point	0.3A maximum	—	100%	—	—	—	0.3A maximum	—	—	0.3A maximum	—	—	1A maximum
	Maximum Load Current	1 common	1A maximum	—	—	—	—	—	1A maximum	—	—	1A maximum	—	—	1A maximum
	Voltage Drop (ON Voltage)	1V maximum (voltage between COM and output terminals when output is ON)			—			1V maximum (voltage between COM and output terminals when output is ON)			1V maximum (voltage between COM and output terminals when output is ON)				
	Inrush Current	1A			—			1A			1A				
	Leakage Current	0.1 mA maximum			—			0.1 mA maximum			0.1 mA maximum				
	Clamping Voltage	39V ± 1V			—			39V ± 1V			39V ± 1V				
	Maximum Lamp Load	8 W maximum			—			8 W maximum			8 W maximum				
	Inductive Load	L/R = 10 ms (28.8V DC, 1 Hz)			—			L/R = 10 ms (28.8V DC, 1 Hz)			L/R = 10 ms (28.8V DC, 1 Hz)				
	External Current Draw	100 mA maximum, 24V DC			—			100 mA maximum, 24V DC (V terminal supply power)			100 mA maximum, 24V DC (V terminal supply power)				
Isolation	Between output terminal and internal circuit	Optocoupler isolated			—			Optocoupler isolated			Optocoupler isolated				
	Between output terminals	Not isolated			—			Same common line: Not isolated Separate common line: isolated			Same common line: Not isolated Separate common line: isolated				
Output Delay	OFF → ON	100µS max.			—			(*1)			(*1)				
Output Delay	ON → OFF	200µS max.			—			(*1)			(*1)				
10A relay	Output Points	4	—	—	4	—	—	—	—	—	—	—	—	—	
	Output Type	1N0 contact	—	—	1N0 contact	—	—	—	—	—	—	—	—	—	
	Rated Load Current	240V AC 10A, 30V DC 10A	—	—	240V AC 10A, 30V DC 10A	—	—	—	—	—	—	—	—	—	
	Minimum Switching Load	10 mA/5V DC (reference value)	—	—	10 mA/5V DC (reference value)	—	—	—	—	—	—	—	—	—	
2A relay	Initial Contact Resistance	100 mΩ maximum (1A, at 6V DC)	—	—	100 mΩ maximum (1A, at 6V DC)	—	—	—	—	—	—	—	—	—	
	Output Points	—	—	—	—	—	—	4	4	8	8	12	—		
	Output Points per Common Line	COM4 COM5 COM6	—	—	—	—	—	—	—	—	—	—	—	—	
	Output Type	—	—	—	—	—	—	—	—	—	—	—	—	—	
Relay Output Common	Maximum Load Current	1 point	—	—	—	—	—	—	—	—	—	—	—	—	
	Maximum Load Current	1 common	—	—	—	—	—	—	—	—	—	—	—	—	
	Minimum Switching Load	—	—	—	—	—	—	—	—	—	—	—	—	—	
	Initial Contact Resistance	—	—	—	—	—	—	—	—	—	—	—	—	—	
	Electrical Life	100,000 operations minimum (resistive load 1,800 operations/h)	—	—	—	—	—	4	4	4	4	4	—	—	
	Mechanical Life	20 million operations minimum (no load 18,000 operations/h)	—	—	—	—	—	—	—	—	—	—	—	—	
	Dielectric Strength	Between output terminal and internal circuit	2,300V AC, 1 minute	—	—	—	—	—	—	—	—	—	—	—	—
		Between output terminals (between COMs)	2,300V AC, 1 minute	—	—	—	—	—	—	—	—	—	—	—	—
	Analog Output	Output Points	—	2	—	—	—	—	—	—	—	—	—	—	—
		Analog Output Signal Type	—	Voltage/Current output (Selectable)	—	—	—	—	—	—	—	—	—	—	—
Analog Output Range		—	0 to 10V DC / 4 to 20mA	—	—	—	—	—	—	—	—	—	—	—	
Load Impedance		—	2kΩ min (voltage input) / 500 Ω max (current input)	—	—	—	—	—	—	—	—	—	—	—	
Applicable Load Type		—	Resistive Load	—	—	—	—	—	—	—	—	—	—	—	
Maximum Deviation at 25°C		—	±0.3% of full scale	—	—	—	—	—	—	—	—	—	—	—	
Temperature Coefficient		—	±0.02%/°C of full scale	—	—	—	—	—	—	—	—	—	—	—	
Repeatability After Stabilization Time		—	±0.4% of full scale	—	—	—	—	—	—	—	—	—	—	—	
Non-linearity		—	±0.01% of full scale	—	—	—	—	—	—	—	—	—	—	—	
Output Ripple		—	30mV max. (spike noise not included)	—	—	—	—	—	—	—	—	—	—	—	
Overshoot	—	0% (*2)	—	—	—	—	—	—	—	—	—	—	—		
Total Error	—	±1.0% of full scale including ripple	—	—	—	—	—	—	—	—	—	—	—		
Effect of Improper Output Connection	—	No damage	—	—	—	—	—	—	—	—	—	—	—		
Digital Resolution	—	0 to 1,000 (10 bits)	—	—	—	—	—	—	—	—	—	—	—		
Output Value of LSB	—	10mV (0-10V) / 16µA (4-20mA)	—	—	—	—	—	—	—	—	—	—	—		
Monotonicity	—	Yes	—	—	—	—	—	—	—	—	—	—	—		
Current loop open	—	Not detectable	—	—	—	—	—	—	—	—	—	—	—		

*1) High-speed output terminal (100 kHz pulse output terminal): 5 µs max. Normal output terminal (including 5kHz pulse output terminal): 100 µs max.

*2) Overshoot may occur under light load conditions. Overshoot can be suppressed by inserting a damping resistor. Damping resistor value: approx. 150Ω including the input impedance.



Download catalogs and CAD from <http://eu.idec.com/downloads>

L-064

FT1A Controllers

Cartridges

Digital I/O Cartridge Specifications

Input Cartridge

Part No.	FC6A-PN4	
Input Points	4 (4/1 common)	
Rated Input Voltage	12/24V DC sink/source input signal	
Input Voltage Range	0 to 28.8V DC	
Rated Input Current	2.5 mA/point (12V DC) 5mA/point (24V DC)	
Input Impedance	4.4 kΩ	
OFF Voltage	5V maximum	
ON Voltage	8.5V minimum	
OFF Current	0.9 mA maximum	
ON Current	1.7 mA minimum (at 8.5V DC)	
Input Delay Time (24V DC)	Turn ON	0.5ms
	Turn OFF	0.5ms
Isolation	Between input terminals: Not isolated Internal circuit: Optocoupler-isolated	
External Load for I/O Interconnection	Not needed	
Signal Determination Method	Static	
Effect of Improper Input Connection	Both sink and source input signals can be connected. If any input exceeding the rated value is applied, permanent damage may be caused.	
Internal Current Draw	All Inputs ON	35mA (3.3V DC) 0mA (24V DC)
	All Inputs OFF	30mA (3.3V DC) 0mA (24V DC)
Internal Power Consumption (at 24V DC while all inputs ON)	0.10W	
Cable Length	3m in compliance with electromagnetic immunity	
Applicable Ferrule	1-wire: AI 0.5-8 WH (Phoenix Contact)	
Weight (approx.)	15g	

Output Cartridge

Part No.	FC6A-PTK4	FC6A-PTS4
Output Points	4 sink (4/1 common)	4 source (4/1 common)
Rated Input Voltage	12/24V DC	
Input Voltage Range	10.2 to 28.8V DC	
Maximum Load Current	Per Point	0.1A
	Per Common	0.4A
Output Delay	Turn ON	450µs maximum
	Turn OFF	450µs maximum
Isolation	Between input terminals: Not isolated Internal circuit: Optocoupler-isolated	
Voltage Drop (ON Voltage)	1V max (voltage between COM and output terminal when output is on.)	
Inrush Current	1A	
Leakage Current	0.1mA maximum	
Clamping Voltage	Approx. 50V	
Maximum Lamp Load	2.4W	
Inductive Load	L/R=10ms (28.8V DC, 1Hz)	
External Current Draw	100mA maximum, 24V DC (power voltage at the +V terminal terminal at source)	100mA maximum, 24V DC (power voltage at the -V terminal at source)
	No	
Overcurrent Protection	All Outputs ON	35mA (3.3V DC) 0mA (24V DC)
	All Outputs OFF	30mA (3.3V DC) 0mA (24V DC)
Internal Power Consumption (at 24V DC while all outputs ON)	0.10W	
Applicable Ferrule	1-wire: AI 0.5-8 WH (Phoenix Contact)	
Weight (approx.)	15g	

FC6A

FT1A

FL1F

Cartridges

Analog Cartridges

Specifications

Part No.	FC6A-PJ2A	FC6A-PJ2CP	FC6A-PK2AV	FC6A-PK2AW
Type	Voltage/Current Input		Temperature Input	Voltage Output
Number of Input/Output	2		2	2
Rated Voltage	5.0V, 3.3V (supplied from the Touch)			
Consumption Current	5.0V: - 3.3V: 30mA		5.0V: 70mA 3.3V: 30mA	5.0V: 185mA 3.3V: 30mA
Weight	15g			

Input Specifications

Part No.	FC6A-PJ2A		FC6A-PJ2CP		
Input Type	Voltage Input	Current Input	Resistance Thermometer	Thermocouple	
Input Range	0 to 10V DC	4 to 20mA DC 0 to 20mA DC	Pt100: -200 to +850°C Pt1000: -200 to +600°C Ni100: -60 to +180°C Ni1000: -60 to +180°C 3-wire RTD	K: -200 to 1300°C J: -200 to 1000°C R: 0 to 1760°C S: 0 to 1760°C B: 0 to 1820°C E: -200 to 8200°C T: -200 to 400°C N: -200 to 1300°C C: 0 to 2315°C	
Input Impedance	1MΩ min.	250Ω max.	1MΩ min.	—	
Allowable Conductor Resistance	—		10Ω max.	—	
Input Detection Current	—		Typ: 0.2mA, 1.0mA max.	—	
AD Conversion	Sample Duration Time	10ms	250ms		
	Sample Interval	20ms	500ms		
	Total Input System Transfer Time	20ms + 1 scan		500ms + 1 scan	
	Type of Input	Single-ended input			
	Operating Mode	Self-scan			
Conversion Method	SAR				
Input Error	Maximum Error at 25°C	±0.1% of full scale	±0.1% of full scale	±0.1% of full scale Cold junction compensation accuracy ±4.0°C or less Exceptions R, S thermocouple error: ±6.0°C (0 to 200 °C range only) B thermocouple error: Not guaranteed (0 to 300 °C range only) K, J, E, T, N thermocouple error: ±0.4% of full scale (0°C or lower range only)	
	Temperature Coefficient	±0.02%/°C of full scale			
	Reproducibility After Stabilization Time	±0.5% of full scale			
	Non-linearity	±0.01% of full scale			
	Maximum Error	±1.0% of full scale			
Data	Digital Resolution	4096 (12 bits)		K: 15,000 (14 bits) J: 12,000 (14 bits) R: 17,600 (15 bits) S: 17,600 (15 bits) B: 18,200 (15 bits) E: 10,000 (14 bits) T: 6,000 (13 bits) N: 15,000 (14 bits) C: 23,150 (15 bits)	
	LSB Input Value	2.44mV (0 to 10V DC)	4.88µA (DC0 to 20mA) 3.91µA (DC4 to 20mA)	0.1°C 0.18°F	
	Data Format in Application	Can be arbitrarily set for each channel in the range of -32,768 to 32,773			
	Monotonicity	Yes			
Noise Resistance	Maximum Temporary Deviation during Electrical Noise Tests	±4.0% of full scale			
	Recommended Cable	Shielded twisted pair		Twisted pair	
	Crosstalk	1LSB max.			
Isolation	None				
Effect When Input is Incorrectly Wired	No damage				
Maximum Allowable Constant Load (non-destructive)	13V DC	40mA	13V DC		
Input Type Modification	Software programming				
Calibration to Maintain Rated Accuracy	Impossible				

Output Specifications

Part No.	FC6A-PK2AV	FC6A-PK2AW	
Type	Voltage Output	Current Output	
Output Type	0 to 10V DC	—	
Output Type	Current Output	4 to 20mA DC	
Load	Impedance	2kΩ min.	
	Load Type	500 kΩ max.	
D/A Conversion	Cycle Time	20ms	
	Settling Time	40ms max.	
	Total Output System Transfer Time	60ms+1 scan	
Output error	Maximum Error at 25°C	±0.3% of full scale	
	Temperature Coefficient	±0.02%/°C of full scale	
	Reproducibility after Stabilization Time	±0.4% of full scale	
	Non-linearity	±0.01% of full scale	
	Output Ripple	30mV max.	
	Overshoot	0%	
	Maximum Error	±1.0% of full scale	
	Effect of Improper Output Terminal Connection	No damage	
	Digital Resolution	4096 (12 bits)	
	LSB Output Value	2.44mV (0 to 10V)	3.91µA (4 to 20mA)
Data Format in Application	0 to 4095 (0 to 10V)	0 to 4095 (4 to 20mA)	
Monotonicity	Yes		
Open Current Loop	—	Cannot be detected	
Noise Resistance	Maximum Temporary Deviation during Electrical Noise Tests	±4.0% of full scale	
	Recommended Cable	Shielded twisted pair	
	Crosstalk	1 LSB max.	
Isolation	None		
Calibration to Maintain Rated Accuracy	Impossible		
Selection of Output Signal Type	Voltage output only	Current output only	

Applicable Wire

Cartridge Part No.	FC6A-PJ2A	FC6A-PJ2CP	FC6A-PK2AV	FC6A-PK2AW
Applicable Wire	0.3mm ² (AWG22) shielded twisted pair	0.3mm ² (AWG22) twisted pair	0.3mm ² (AWG22) shielded twisted pair	

- APEM
- Switches & Pilot Lights
- Control Boxes
- Emergency Stop Switches
- Enabling Switches
- Safety Products
- Explosion Proof
- Terminal Blocks
- Relays & Sockets
- Circuit Protectors
- Power Supplies
- LED Illumination
- Controllers
- Operator Interfaces
- Sensors
- AUTO-ID
- FC6A
- FT1A
- FL1F



Download catalogs and CAD from <http://eu.idec.com/downloads>

L-066

FT1A Controllers

Expansion Communication Cartridges

Specifications

Part No.	FT1A-PC1	FT1A-PC2	FT1A-PC3
Termination Connector	Mini DIN	Mini DIN	Screw Terminal block
Standards	EIA RS232C	EIA RS485	EIA RS485
Maximum Baud Rate	115,200 bps	115,200 bps	115,200 bps
Communication Functions	Maintenance communication, User communication, Modbus RTU master/slave	Maintenance communication, User communication, odbus RTU master/slave	Maintenance communication, User communication, Modbus RTU master/slave
Isolation between Internal Circuit and Communication Port	Not isolated	Not isolated	Not isolated
Recommended Communication Cable	Special cable	Special cable	Twisted-pair shielded cable with a minimum core wire of 0.3 mm ² (Conductor resistance 85 Ω/km maximum, shield resistance 20 Ω/km maximum)
Maximum Cable Length	—	—	200m

Mounting Hole Layout

Touch

FT1A-*12RA-*

FT1A-*14*A-*

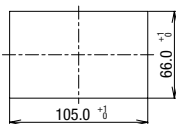

Pro/Lite

FT1A-*12**

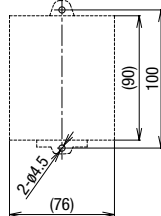

FT1A-*24**

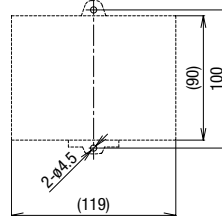

FT1A-*40**/FT1A-*48**

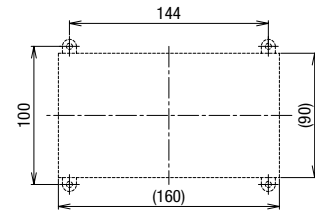

All dimensions in mm.

Dimensions

Touch (Display Model) / Relay Output Model (FT1A-12RA-*)

When using mounting bracket (HG9Z-4K2PN04)

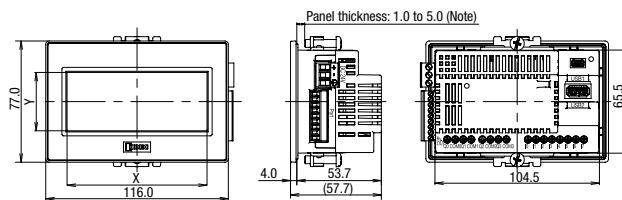

Note: Waterproof characteristic may not be obtained depending on the panel material and size.

When using rear mount adapter (FT9Z-1A01)

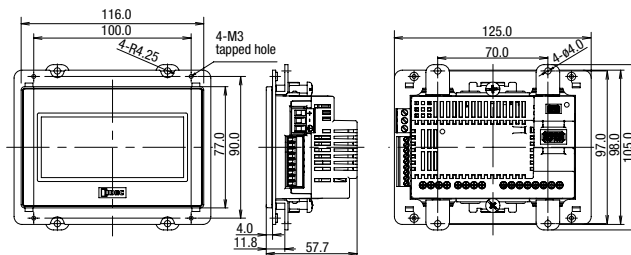

Dimensions

Touch (Display Model)/Transistor Output Model (FT1A-14KA-* / FT1A-14SA-*)
When using mounting bracket (HG9Z-4K2PN04)

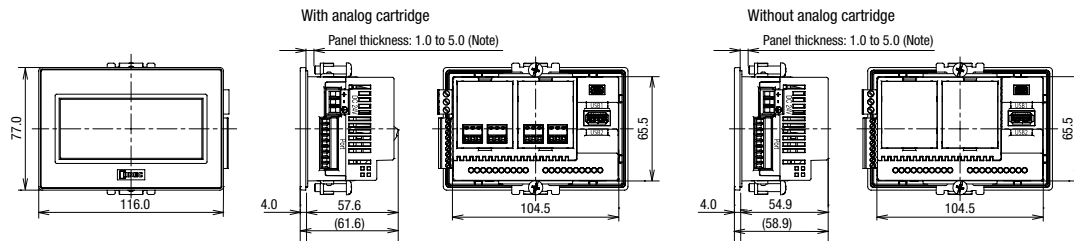

Note: Waterproof characteristic may not be obtained depending on the panel material and size.

When using rear mount adapter (FT9Z-1A01)

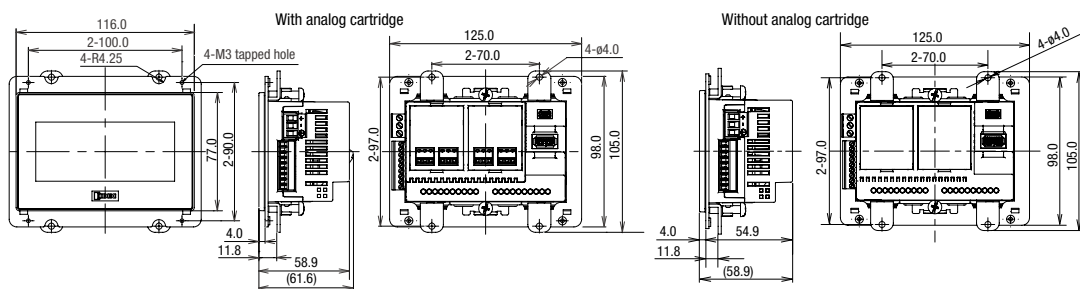

Pro (LCD Model)

Lite (No LCD Model)

FT1A-H12*A/*C

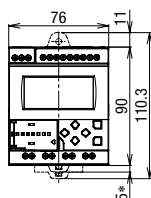

FT1A-H24*A/*C

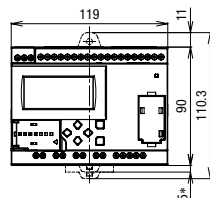

FT1A-B12*A/*C

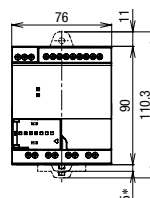

FT1A-B24*A/*C

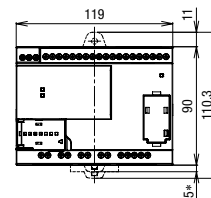

FT1A-H40*A/*C

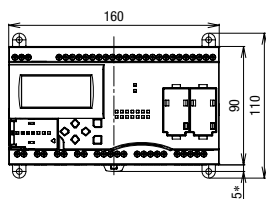

FT1A-H**A

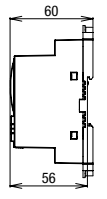

FT1A-H**C

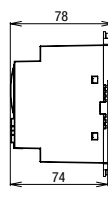

FT1A-B40*A/*C

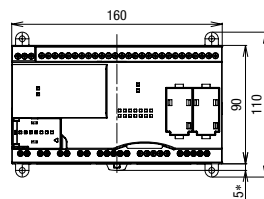

FT1A-B**A

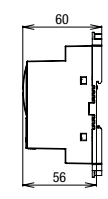

FT1A-B**C

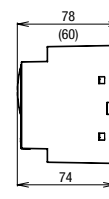

FT1A-H48*A/*C

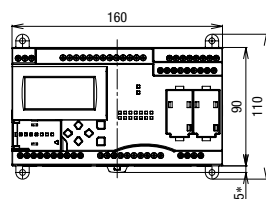

FT1A-B48*A/*C

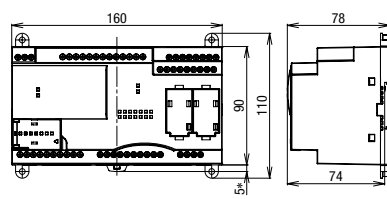

Note: 9.3 mm when the clamp is pulled out.

Note: 9.3 mm when the clamp is pulled out.

All dimensions in mm.

Download catalogs and CAD from <http://eu.idec.com/downloads>

L-068

FT1A Controllers

Terminal Arrangement and I/O Wiring Diagram Examples

For terminal arrangement and I/O wiring diagram, see Instruction Sheet.

Touch (Display Model)

FT1A-*12RA-*

: Fuse : Load

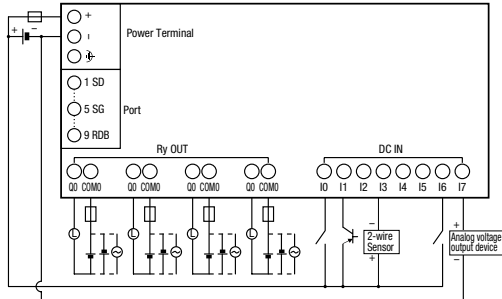

FT1A-*14KA-*

FT1A-*14SA-*

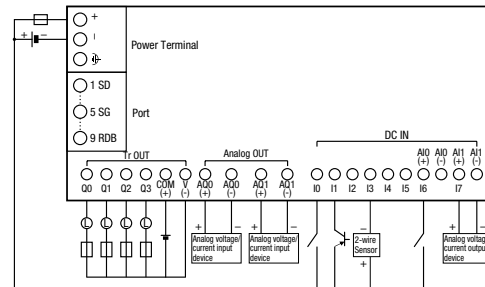
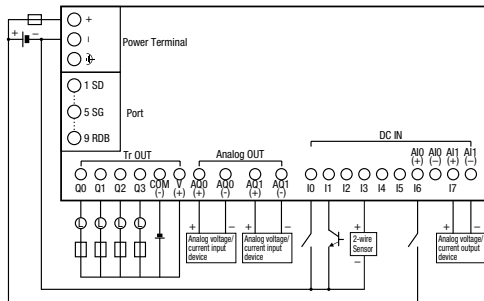

Pro/Lite (LCD/No LCD Models)

FT1A-*12RA

Input Side

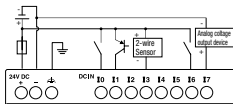

Output Side

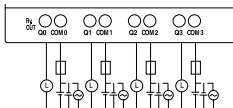

FT1A-*12RC

Input Side

No-voltage

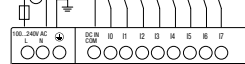

Output Side

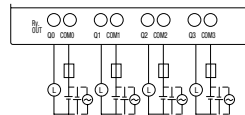

External power for input cannot be used.

FT1A-*24RA

Input Side

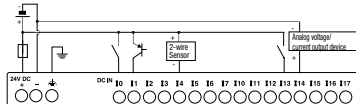

Output Side

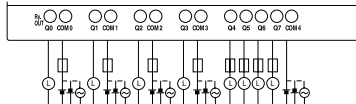

FT1A-*24RC

Input Side (sink/source)

Source Input

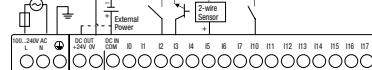

Sink Input

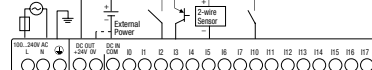

Output Side

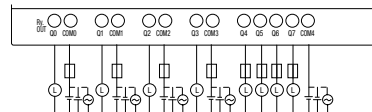

Terminal Arrangement and I/O Wiring Diagram Examples

For terminal arrangement and I/O wiring diagram, see Instruction Sheet.

Pro/Lite (LCD/No LCD Models)

FT1A-*40RC

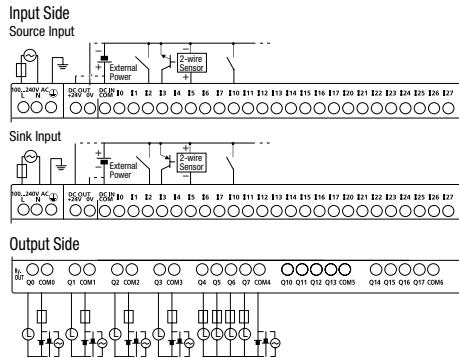

FT1A-*40RSA

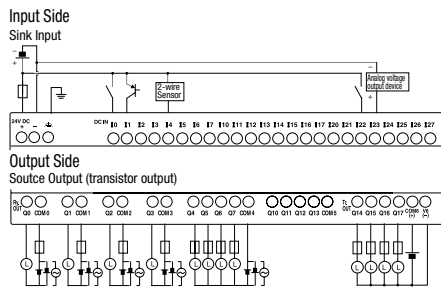

FT1A-*48KA

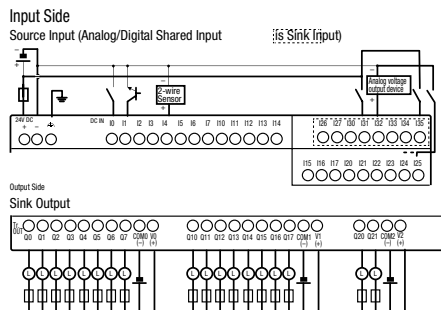

FT1A-*40RKA

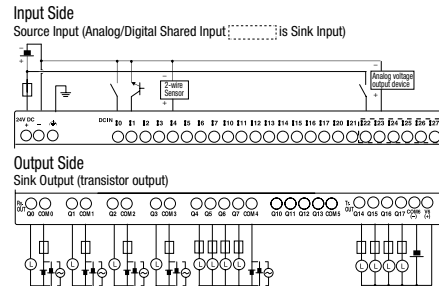

FT1A-*48SA

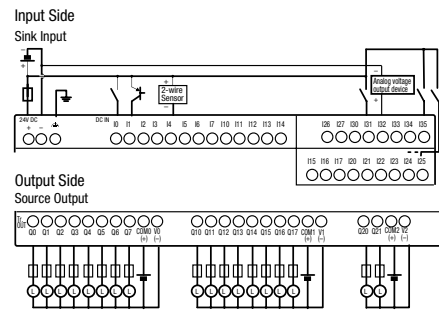

Recommended Ferrules for Touch/Pro/Lite Terminals

Touch (LCD Model), Pro/Lite (LCD/No Models)

(All dimensions in mm)

Type	Cross Section (mm ²)	AWG	Phoenix Contact Part No.	Ordering No.	Package Quantity	Touch			Pro/Lite		FC6A Cartridge	L1	L2	d1	S1	d2	d3	S2	
						Power Supply	Serial Interface	Relay Output Model	Transistor Output Model	Power Supply									I/O
1-wire connection	0.25	24	AI 0.25-6 BU	3203040	100	—	—	—	—	—	×	10.5	6.0	0.8	0.15	1.8	—	0.25	
	0.34	22	AI 0.34-6 TQ	3203053	100	—	—	—	—	—	×	10.5	6.0	0.8	0.15	1.8	—	0.25	
			AI 0.34-8 TQ	3203066	100	x	x	x	x	—	—	—	12.5	8.0	0.8	0.15	2.0	—	0.25
	0.5	20	AI 0.5-6 WH	3200687	100	—	—	—	—	—	—	×	12.0	6.0	1.1	0.15	2.5	—	0.3
			AI 0.5-8 WH	3200014	100	x	x	x	x	x	—	—	14.0	8.0	1.1	0.15	2.5	—	0.25
	0.75	18	AI 0.75-8 GY	3200519	100	x	—	—	—	—	—	—	14.0	8.0	1.3	0.15	2.8	—	0.25
	1.0		AI 1-8 RD	3200030	100	x	—	—	—	—	—	×	14.0	8.0	1.5	0.15	3.0	—	0.3
AI 1-10 RD			3200182	100	—	—	x	—	—	—	—	16.0	10.0	1.5	0.15	3.0	—	0.3	
1.5	16	AI 1.5-8 BK	3200043	100	x	—	—	—	—	—	×	14.0	8.0	1.8	0.15	3.4	—	0.3	
		AI 1.5-10 BK	3200195	100	—	—	x	—	—	—	—	18.0	10.0	1.8	0.15	3.4	—	0.3	
2-wire connection	0.5	20	AI-TWIN2×0.5-8 WH	3200933	100	x	x	—	x	—	—	15.0	8.0	1.5	0.15	2.5	4.6	0.25	
			AI-TWIN2×0.75-8 GY	3200807	100	x	—	—	—	x	—	—	15.0	8.0	1.8	0.15	2.8	5.2	0.25
Screwdriver			SZS 0.6×3.5	1205053	10	x	—	x	—	x	—	—	—	—	—	—	—	—	
			SZS 0.4×2.5	1205037	10	—	x	—	x	—	—	—	—	—	—	—	—	—	—

Note: Crimping pliers - Phoenix Contact part number CRIMPFOX 6 (1212034)

For 1-wire connection

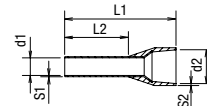

For 2-wire connection

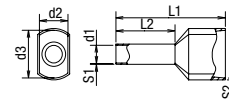

All dimensions in mm.



Download catalogs and CAD from <http://eu.idec.com/downloads>

L-070

FT1A Controllers

Instructions

Basic Instructions (Touch/Pro/Lite)

Instructions	Function
LOD	Stores intermediate results and reads contact status
LODN	Stores intermediate results and reads inverted contact status
AND	Series connection of NO contact
ANDN	Series connection of NC contact
OR	Parallel connection of NO contact
ORN	Parallel connection of NC contact
ANDL0D	Series connection of circuit blocks
ORL0D	Parallel connection of circuit blocks
BPS	Saves the result of bit logical operation temporarily
BRD	Reads the result of bit logical operation which was saved temporarily
BPP	Restores the result of bit logical operation which was saved temporarily
OUT	Outputs the result of bit logical operation
OUTN	Output the inverted result of bit logical operation
SET	Sets output, internal relay, or shift register bit
RST	Resets output, internal relay, or shift register bit
TMS	Subtracting 1-ms on-delay timer (0 to 65.535 sec)
TMH	Subtracting 10-ms on-delay timer (0 to 655.35 sec)
TIM	Subtracting 100-ms on-delay timer (0 to 6553.5 sec)
TML	Subtracting 1-sec on-delay timer (0 to 65535 sec)
TMSO	Subtracting 1-ms off-delay timer (0 to 65.535 sec)
TMHO	Subtracting 10-ms off-delay timer (0 to 655.35 sec)
TIMO	Subtracting 100-ms off-delay timer (0 to 6553.5 sec)
TMLO	Subtracting 1-sec off-delay timer (0 to 65535 sec)
CNT	Adding counter (0 to 65,535)
CNTD	Double-word adding counter (0 to 4,294,967,295)
CDP	Dual pulse reversible counter (0 to 65,535)
CDPD	Double-word dual pulse reversible counter (0 to 4,294,967,295)
CUD	Up/down selection reversible counter (0 to 65,535)
CUDD	Double-word up/down selection reversible counter (0 to 4,294,967,295)
CC=	Equal to comparison of counter current value
CC≥	Greater than or equal to comparison of counter current value
DC=	Equal to comparison of data register value
DC≥	Greater than or equal to comparison of data register value
SFR	Forward shift register
SFRN	Reverse shift register
SOTU	Rising-edge differentiation output
SOTD	Falling-edge differentiation output
JMP	Jumps a designated program area
JEND	Ends a jump instruction
MCS	Starts a master control
MCR	Ends a master control
END	Ends a program

Advanced Instructions (Touch/Pro/Lite continued)

Instructions	Name
RAD	Degree to Radian
DEG	Radian to Degree
SIN	Sine
COS	Cosine
TAN	Tangent
ASIN	Arc Sine
ACOS	Arc Cosine
ATAN	Arc Tangent
LOGE	Natural Logarithm
LOG10	Common Logarithm
EXP	Exponent
POW	Power
ANDW	AND Word
ORW	OR Word
XORW	Exclusive OR Word
SFTL	Shift Left
SFTR	Shift Right
BCDLS	BCD Left Shift
WSFT	Word Shift
ROTL	Rotate Left
R0TR	Rotate Right
HTOB	Hex to BCD
BTOH	BCD to Hex
HTOA	Hex to ASCII
ATOH	ASCII to Hex
BTOA	BCD to ASCII
ATOB	ASCII to BCD
ENCO	Encode
DECO	Decode
BCNT	Bit Count
ALT	Alternate Output
CVDT	Convert Data Type
DTDV	Data Divide
DTCB	Data Combine
SWAP	Data Swap
TXDn (Note 1)	Transmit
RXDn (Note 1)	Receive
ETXDn (Note 1)	Transmit over Ethernet
ERXDn (Note 1)	Receive over Ethernet
LABEL	Label
LJMP	Label Jump
LCAL	Label Call
LRET	Label Return
DJNZ (Note 2)	Decrement Jump Non-zero
MSG (Note 2)	Message
IOREF	I/O Refresh
HSCRF (Note 3)	High-speed Counter Refresh
WEEK	Week Timer
YEAR	Yearly Timer
TADD	Time Addition
TSUB	Time Subtraction
HOUR	Hour Meter
HTOS	HMS to Sec
STOH	Sec to HMS
DTML	1-sec Dual Timer
DTIM	100-ms Dual Timer
DTMH	10-ms Dual Timer
DTMS	1-ms Dual Timer
TTIM	Teaching Timer
PULSn (Note 4)	Pulse Output
PWMn (Note 4)	Pulse Width Modulation
RAMPn (Note 4)	Ramp Pulse Output
ZRNn (Note 4)	Zero Return
ARAMPn (Note 4)	Advanced Ramp
DI	Disable Interrupt
EI	Enable Interrupt
XYFS	XY Format Set
CVXTY	Convert X to Y
CVYTX	Convert Y to X
PID (Note 5)	Perform PID control
AVRG	Average
FIFO	FIFO Format
FIEX	First-In Execute
FOEX	First-Out Execute
NDSRC	N Data Search
SCRPT	Script
DLOG (Note 6)	Data Logging
TRACE (Note 6)	Data Trace

Note 1: Pro/Lite 24-I/O, 40-I/O, 48-I/O type only

Note 2: Pro only

Note 3: Touch, Pro/Lite DC power type only

Note 4: Pro/Lite 40-I/O DC type and 48-I/O AC/DC type only

























Note 5: Touch transistor output model only (FT1A-*14SA/FT1A-*14KA)

Note 6: Pro/Lite 40-I/O, 48-I/O only

Advanced Instructions (Touch/Pro/Lite)

Instructions	Name
NOP	No Operation
MOV	Move
MOVN	Move Not
IMOV	Indirect Move
IMOVN	Indirect Move Not
IBMV	Indirect Bit Move
IBMVN	Indirect Bit Move Not
BMOV	Block Move
NSET	N Data Set
NRS	N Data Repeat Set
XCHG	Exchange
TCCST	Timer/Counter Current Value Store
CMP=	Compare Equal To
CMP<>	Compare Unequal To
CMP<	Compare Less Than
CMP>	Compare Greater Than
CMP<=	Compare Less Than or Equal To
CMP>=	Compare Greater Than or Equal To
ICMP>=	Interval Compare Greater Than or Equal to
LC=	Load Compare Equal To
LC<>	Load Compare Unequal To
LC<	Load Compare Less Than
LC>	Load Compare Greater Than
LC<=	Load Compare Less Than or Equal To
LC>=	Load Compare Greater Than or Equal To
ADD	Addition
SUB	Subtraction
MUL	Multiplication
DIV	Division
INC	Increment
ADD	Addition
SUB	Subtraction
MUL	Multiplication
DIV	Division
INC	Increment
DEC	Decrement
ROOT	Root
SUM	Sum

Function Blocks

Type	Symbol	Name and Diagram	Function
Input	I	 Digital Input	Inputs ON/OFF information from an external to the SmartAXIS.
	SM	 Special Internal Relay	Special internal relays can be used as bit inputs for FBs in the SmartAXIS. Special function is allocated to each special internal relay.
	R	 Shift Register	Outputs ON/OFF state of a shift register device.
	AI	 Analog Input	The analog input values (0 to 10V DC) for the analog input terminals are converted to digital values (0 to 1,000) and output. With the analog input linear conversion function, the analog input value can be linearly conversion within a range of -32,768 to 32,767.
Output	Q	 Digital Output	Outputs ON/OFF information from the SmartAXIS to an external device.
	M	 Internal Relay	A bit unit FB used internally by the SmartAXIS.
Logical Operation	AND	 Logical AND	Implements logical AND for a maximum of four input signals (ON/OFF) and outputs the result.
	NAND	 Negative Logical AND	Implements negative logical AND for a maximum of four input signals (ON/OFF) and outputs the result.
	OR	 Logical OR	Implements logical OR for a maximum of four input signals (ON/ OFF) and outputs the result.
	NOR	 Negative Logical OR	Implements negative logical OR for a maximum of four input signals (ON/OFF) and outputs the result.
	XOR	 Exclusive Logical OR	Implements exclusive logical OR for a maximum of two input signals (ON/OFF) and outputs the result.
	NXOR	 Negative Exclusive Logical OR	Implements negative exclusive logical OR for a maximum of two input signals (ON/OFF) and outputs the result.
	NOT	 Negation	Outputs the result of negating the input signal (ON/OFF).
	SOTU	 Shot up	Turns on the output for one scan when the input signal turns from off to on.
	SOTD	 Shot down	Turns on the output for one scan when the input signal turns from on to off.
	TRUTH	 Truth Table	A truth table for the output can be configured corresponding to the 16 patterns combination of the four input signals, and TRUTH FB outputs the result according to the table.
Timer	TIMU	 On-delay Count Up Timer	After the execution input turns on, the output turns on when the on-delay time elapses. The current value is incremented from zero to the preset value.
	TIMD	 On-delay Count Down Timer	After the execution input turns on, the output turns on when the on-delay time elapses. The current value is decremented from the preset value to zero.
	TIMOU	 Off-delay Count Up Timer	When the execution input turns on, the output turns on. After the execution input turns off, the output turns off when the off-delay time elapses. The current value is incremented from zero to the preset value.
	TIMOD	 Off-delay Count Down Timer	When the execution input turns on, the output turns on. After the execution input turns off, the output turns off when the off-delay time elapses. The current value is decremented from the preset values to zero.
	TIMCU	 On/off-delay Timer	After the execution input turns on, the output turns on when the on-delay time elapses. After the execution input turns off, the output turns off when the off-delay time elapses.
	SPULS	 Single Shot Pulse	After the execution input turns on, the output turns on for the configured time period.
	DTIM	 Dual Timer	The output is turned on and off according to the configured ON and OFF time.
	RPULS	 Random Pulse Output	The output is turned on for the length of random time within the configured range of time.

- APEM
- Switches & Pilot Lights
- Control Boxes
- Emergency Stop Switches
- Enabling Switches
- Safety Products
- Explosion Proof
- Terminal Blocks
- Relays & Sockets
- Circuit Protectors
- Power Supplies
- LED Illumination
- Controllers
- Operator Interfaces
- Sensors
- AUTO-ID
- FC6A
- FT1A
- FL1F

 [Download catalogs and CAD from http://eu.idec.com/downloads](http://eu.idec.com/downloads)

FT1A Controllers

- APEM
- Switches & Pilot Lights
- Control Boxes
- Emergency Stop Switches
- Enabling Switches
- Safety Products
- Explosion Proof
- Terminal Blocks
- Relays & Sockets
- Circuit Protectors
- Power Supplies
- LED Illumination

- Controllers
- Operator Interfaces
- Sensors

AUTO-ID

- FC6A
- FT1A**
- FL1F

Counter	CNT		When the clock input is turned on, the current value is incremented by one. The output turns on when the current value reaches the preset value.
	CUD		When the clock input is turned on, the current value is incremented or decremented by one according to the up/down selection input. The current value is compared with ON/OFF thresholds. The output turns on or off according to the comparison result.
	HOUR		Accumulates the ON duration of the execution input in hours, minutes, and seconds. The output turns on when the accumulated time reaches the configured time.
Shift Register	SFR		When the execution input turns on, the shift registers are shifted to the specified shift direction.
Data Comparison	CMP		Two inputs values are compared and the output turns on or off according to the comparison result.
	STTG		The comparison input value and the ON/OFF thresholds are compared and the output turns on or off according to the comparison result.
	RCMP		The comparison input value and the upper/lower limits are compared and the output turns on or off according to the comparison result.
Data Conversion	ALT		Sets/resets the output.
Week Programmer	WEEK		Compares the specified day of the week, ON time, and OFF time with the current time and outputs the result.
	YEAR		Compares the specified date with the current date and outputs the result.
Interface (Note 1)	MSG		Displays data such as text and device values on the LCD on the SmartAXIS Pro.
Pulse (Note 2)	PULS		Outputs pulses at the specified frequency.
	PWM		Outputs pulses at the specified frequency and duty cycle.
	RAMP		Outputs pulses with the frequency change function.
	ZRN		Outputs pulses with the different pulse frequency corresponding to the on/off state of a deceleration signal.
	ARAMP		Output pulses with the frequency change function according to the settings configured in the frequency table.
Data Logging (Note 3)	DLOG		Saves the values of the specified devices in the specified data format as a CSV file to the SD memory card.
	TRACE		Saves the values of the previous number of scans for the specified device in the specified data format as a CSV file to the SD memory card.
Script	SCRIPT		Enables you to program complicated processing with the script language that supports conditional branching, logical operations, arithmetic operations, and functions.
Special	HSC		Operates the high-speed counter configured in the function area settings. Turns on/off the high-speed counter gate input/reset input/clear input.
	RSFF		When the set input turns on, the output turns on and keeps on. When the reset input turns on, the output turns off.

Note 1: Pro only
 Note 2: Pro/Lite 40-I/O DC type and 48-I/O AC/DC type only
 Note 3: Pro/Lite 40-I/O, 48-I/O only
 Note 4: Touch, Pro/Lite DC power type only

Scripts

Type	Format	Description
Control statements	if	if ((Cond.expr.)) { Exe.line ; }
	if else	if ((Cond.expr.)) { Exe.line1 ; } else { Exe.line2 ; }
	if else if else	if ((Cond.expr1.)) { Exe.line1 ; } else if ((Cond.expr2.)) { Exe.line2 ; } else { Exe.line3 ; }
	switch case default	switch (Cond.expr.) {case constant 1: (Cond.expr1.);break; case constant2: (Cond.expr2.); break; default: (Cond.expr3.);break;}
	while	while ((Cond.expr.)) { Exe.line ; }
	break	break;
return	return;	Script is ended.
Relational operator	==, !=, <, >, <=, >=	Two values are compared.
Logical operator	&&, , !	Logical operation of two values (AND, OR, NOT).
Arithmetic operator	+, -, *, /, %, =	Addition, subtraction, multiplication, division, remainder, assignment
Bit operator	&, , ^, ~, <<, >>	Logical product (AND), logical sum (OR), exclusive logical sum (XOR), reverse, shift left, shift right
Bit function	Bit set	SET ([a]);
	Bit reset	RST ([a]);
	Bit reverse	REV ([a]);
Arithmetic operation	Maximum value	MAX([a], [b], [c])
	Minimum value	MIN([a], [b], [c])
	Exponential function	EXP([a])
	Natural logarithm	LOGE([a])
	Common logarithm	LOG10([a])
	Exponentiation	POW([a], [b])
	Square root	ROOT([a])
	Sine	SIN([a])
	Cosine	COS([a])
	Tangent	TAN([a])
	Arcsine	ASIN([a])
	Arccosine	ACOS([a])
	Arctangent	ATAN([a])
	Conversion from angle to radian	RAD([a]);
Conversion from radian to angle	DEG([a]);	
Data type conversion	Conversion from BCD to Binary	BCD2BIN([a])
	Conversion from binary to BCD	BIN2BCD([a])
	Conversion from float32 to binary	FLOAT2BIN([a])
	Conversion from binary to float32	BIN2FLOAT([a])
	Conversion from decimal to string character	DEC2ASCII([a], [b])
	Conversion from string character to decimal	ASCII2DEC([a])
	Data comparison	MEMCMP([a], [b], [c])
	Data copy	MEMCPY([a], [b], [c])
	Character string copy	STRCUT([a], [b], [c], [d])
	Character number count	STRLEN([a])
Character string concatenation	STRCAT([a], [b])	
Character string search	STRSTR([a], [b])	
Draw (Note 1)	Drawing of straight line	LINE([a], [b], [c], [d])
	Drawing of rectangle	RECTANGLE([a], [b], [c], [d])
	Drawing of circle and ellipse	CIRCLE([a], [b], [c], [d])
Offset	Indirect specification	OFFSET([a], [b])
Bit device ↔ word device Cross Operator Functions (Note 2)	Bit device (1 word length) to bit device (1 word length)	BITS2BITS([a], [b])
	Bit device (1 word length) to Word device	BITS2WORD([a], [b])
	Word device to bit device (1 word length)	WORD2BITS([a], [b])

Note 1: Touch (WindO/I-NV3) only

Note 2: Pro/Lite (WindLDR)



Download catalogs and CAD from <http://eu.idec.com/downloads>

L-074