

FB series Control Stations

**IP65 lightweight control stations.
IDEC HW and XW series switches and pilot lights installed.**

- ø22 mm switches/pilot lights can be installed.
- Blank front enclosures, without mounting holes, are also available.
- Blank front enclosures can also be used as junction boxes to mount terminal blocks.
- Yellow cover enclosures for emergency stop switches are also available.
- Front panel mounting, rear panel mounting, hook mounting, and frame mounting options are available.



- Contact cover box (Part no.: FB1WBR) is not UL or c-UL listed.
- Enclosures without mounting hole is not UL or c-UL listed. (Enclosures less than 1,639 cm² is not approved by UL50, 2:8.)
- See website for details on approvals and standards.



- APEM
- Switches & Pilot Lights
- Control Boxes
- Emergency Stop Switches
- Enabling Switches
- Safety Products
- Explosion Proof
- Terminal Blocks
- Relays & Sockets
- Circuit Protectors
- Power Supplies
- LED Illumination
- Controllers
- Operator Interfaces
- Sensors
- AUTO-ID

Enclosures

Package Quantity: 1

Size	No. of Mounting Holes	Mounting Hole Description	Cover Color (*1)	Part No.
76mm	0	Without mounting hole	Light beige	FB1T-000Z
	1	ø22mm	Yellow	FB1W-111Y
140mm	1	ø22mm	Light beige	FB1W-111Z
	0	Without mounting hole	Light beige	FB2T-000Z
	2	ø22mm, mounting centers 50mm	Light beige	FB2W-211Z
200mm	3	ø22mm, mounting centers 30mm	Light beige	FB2W-312Z
	0	Without mounting hole	Light beige	FB3T-000Z
	3	ø22mm, mounting centers 50mm	Light beige	FB3W-311Z
	4	ø22mm, mounting centers 36mm	Light beige	FB3W-413Z
	5	ø22mm, mounting centers 30mm	Light beige	FB3W-512Z

*1) Light beige (Munsell 5Y7/1 or equivalent), Yellow (Munsell 2.5Y8/10 or equivalent), Enclosure base color: Black (Munsell N1.5 or equivalent)

Contact Cover Box

Package Quantity: 1

Size	No. of Mounting Holes	Mounting Hole Description	Cover Color	Part No.
76mm	1	ø22 mm hole in the base	Light beige	FB1WR-111Z

• For operating instructions, see C-019.

Accessories

Description	Part No.	Ordering No.	Package Quantity
Mounting Bracket	FB9Z-PK1	FB9Z-PK1	1
DIN Rail Adapter	FB9Z-PK3	FB9Z-PK3PN02	2
Mounting Hole Plug	LW9Z-BP1	LW9Z-BP1	1

• Connectors and nuts are supplied by users.

Specifications (*2)

Applicable Standards	IEC/EN60529 UL508 UL50 CSA C22.2 No. 14 CSA C22.2 No. 94
Standard Operating Conditions	Ambient temperature: -25 to +60°C (no freezing) Relative humidity: 45 to 85%RH (no condensation) Storage temperature: -40 to +80°C (no freezing) Degree of pollution: 3
Degree of Protection	IP65 (when IP65 switches/pilot lights are installed) NEMA Type 4X Indoor Use Only (when Type 4X switches/pilot lights are installed)
Electric Shock Protection	Class II (when class II switches/pilot lights are installed)
Material	Box cover / box base: polycarbonate (*5) Box cover mounting screw: stainless
Applicable Switches/Pilot Lights	IDEC's HW/TW/XW series and accessories (*3) (*4)
Weight (approx.)	76 mm: 125g (FB1W-111Y) 140 mm: 184g (FB2W-211Z) 200 mm: 243g (FB3W-311Z)

*2) The above specifications are for enclosures. For switches/pilot lights, refer to the specifications of each unit.

*3) Choose switches/pilot lights and accessories which match the mounting hole centers, effective depth behind the cover, and the thickness of the cover where switches/pilot lights are installed (3 mm). Note that enclosures with 30 mm or 36 mm mounting hole centers may limit the knob orientation of selector switches, because the contact blocks can be mounted in one direction only on these mounting centers.

*4) An XW series emergency stop switch of screw terminal model can be installed on an enclosure with one mounting hole or mounting holes of 50 mm mounting centers, by connecting one clamping terminal to one terminal pole.

*5) Flame-resistant (UL94V-0).

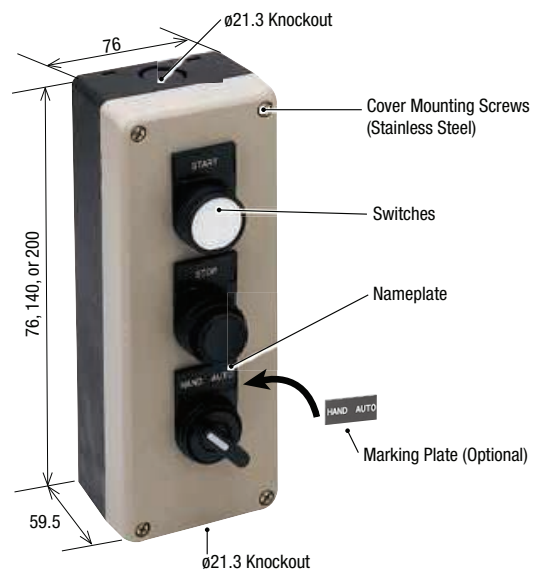

FB Series Control Stations

Control Boxes

Dimensions

All dimensions in mm.

76 mm (FB1)

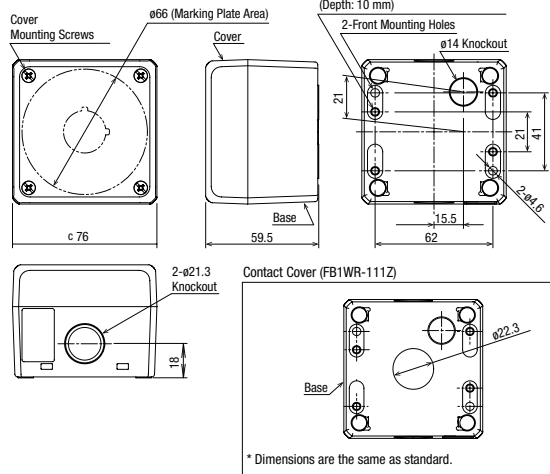

140/200 mm (FB2/FB3)

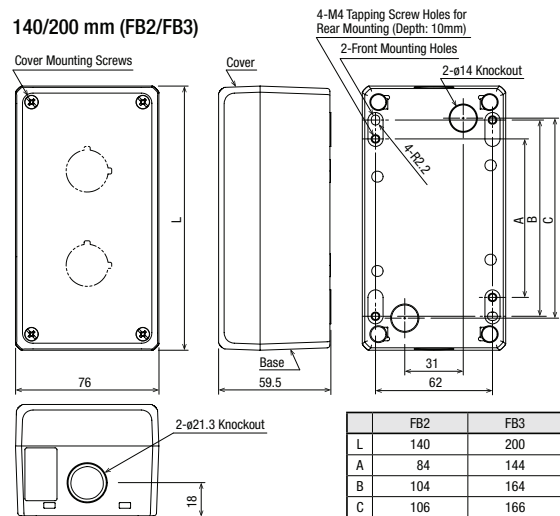

FB Series Control Stations
With ø22 mm XW Series EMO Switches

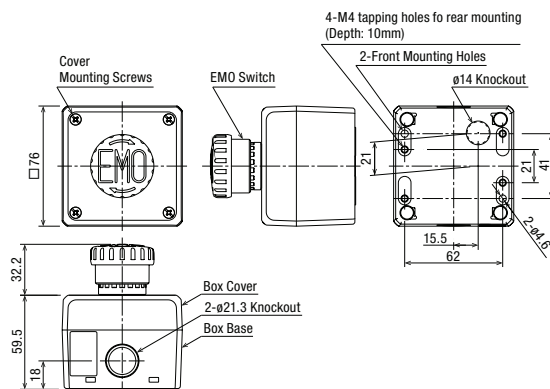

FB Series Control Stations
With ø22 mm XW Series EMO Switches +
SEMI Switch Guard (HW9Z-KG3)

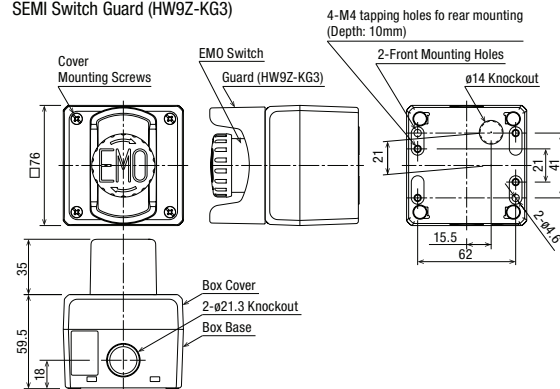

FB Series Control Stations
With ø22 mm XW Series EMO Switches +
SEMI Switch Guard (HW9Z-KG4)

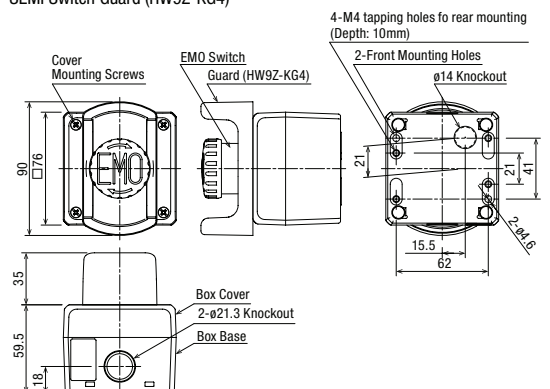

Internal Dimensions

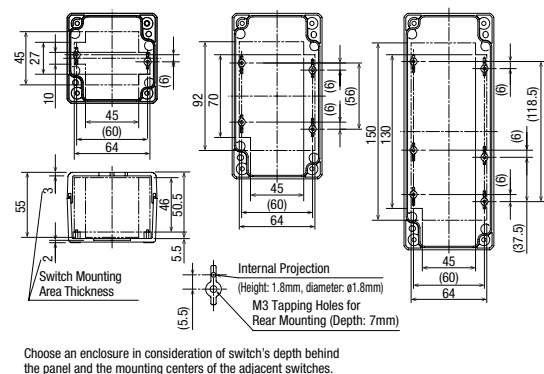

- APEM
- Switches & Pilot Lights
- Control Boxes
- Emergency Stop Switches
- Enabling Switches
- Safety Products
- Explosion Proof
- Terminal Blocks
- Relays & Sockets
- Circuit Protectors
- Power Supplies
- LED Illumination
- Controllers
- Operator Interfaces
- Sensors
- AUTO-ID

FB

Download catalogs and CAD from <http://eu.idec.com/downloads>

C-008

FB Series Control Stations

Switch/Pilot Light Mounting Hole Centers

Model	76mm	140mm		200mm		
		2 mounting holes	3 mounting holes	3 mounting holes	4 mounting holes	5 mounting holes
Shape						

APEM

Switches & Pilot Lights

Control Boxes

Emergency Stop Switches

Enabling Switches

Safety Products

Explosion Proof

Terminal Blocks

Relays & Sockets

Circuit Protectors

Power Supplies

LED Illumination

Controllers

Operator Interfaces

Sensors

AUTO-ID

FB

Applicable Accessories

Series	Description
HW Series	Nameplate: HWAM, HWAQ, HWAS, HWAV-□
	Marking plate for nameplate: HWNP-□
	Anti-rotation ring: HW9Z-RL
	EMO switch guard: HW9Z-KG3, HW9Z-KG4
	Switch guard: HW9Z-K1, HW9Z-K11
	Pushbutton clear boot: OC-31, OC-32
XW Series Emergency Stop Switches	Padlock cover: HW9Z-KL1
	Nameplate: HWAV-□
	EMO switch guard: HW9Z-KG3, HW9Z-KG4
TW Series	Anti-rotation ring: HW9Z-RL
	Nameplate: NWA-□, NWAQ-□, NWAQ-0, NWAQ-0, NWAQ-0, NWAQ-0
	Anti-rotation ring: OGL-31
	Metal protector: OLW-C
	Pushbutton clear boot: OC-31, OC-32
	Button cover: OCW-10*, OCW-11*
Padlock cover: HW9Z-KL1, HS9Z-PC22	

Note: Confirm the specifications of boxes, switches/pilot lights, and accessories before choosing accessories, referring to separate catalogs.

Mounting Hole Dimensions

Model	76mm	140mm	200mm	140/200mm
		50 mm mounting centers	36/50 mm mounting centers	30 mm mounting centers
Shape				

Note: For contact cover boxes, see C-019.

Applicable DIN Rail

Description	Material	Part No.	Ordering No.
DIN Rail	Aluminum	BAA1000	BAA1000PN10
	Steel	BAP1000	BAP1000PN10
End Clip	Steel	BNL6	BNL6PN10

Note: Use DIN rail adapters FB9Z-PK3 when installing a DIN in the control box. See H-071 for DIN rail products.

Applicable Terminal Block / Transformer

Series / Part No.	
Terminal Block	BN-W / BNH-W / BN1U BN10W, BN15MW, BN15LW, BN30W BNH10W, BNH15MW, BNH15LW, BNH30W BN1U-16W, BN1U-20W, BN1U-40W
	BA BA111T, BA211T, BA311T
Separate Mounting Transformer TWR5**	

Note: Install the terminal blocks and separate mounting transformers on a DIN rail using two DIN rail adapters (FB9Z-PK3). Choose the types and quantity of terminal blocks, transformers, end clips, and enclosures carefully taking the specifications into consideration. The separate mounting transformer can be installed on a DIN rail adapter directly.

Control Stations

Symbols of Switches

Symbols	Item
	Emergency Stop Switches
	Pushbuttons
	Pilot Lights
	Selector Switches
	Key Selector Switches

Legend / Guard

Legend / Guard	Nameplate Part No.	Guard / Marking Plate Part No.
E-STOP Nameplate	<Optional marking plate>	HWAM
	<Yellow - Blank>	HWAV-0
	EMERGENCY-STOP	HWAV-27
Nameplate	ON	HWAM
	OFF	HWAM
	START	HWAM
	STOP	HWAM
	OFF-ON	HWAM
	HAND-AUTO	HWAM
	HAND-OFF-AUTO	HWAM
Guard	HW9Z-KG4	-
	HW9Z-KG3	-

1 Hole (Box Size: 76mm)

Symbols	Specification	Switch Part No.	Legend	<Without nameplate>		With nameplate "EMERGENCY STOP"	
			Contact Configuration	Part No. (Ordering Part No.)	Color (*)	Part No. (Ordering Part No.)	Color (*)
	XW Series Emergency Stop Switches (Non-illuminated, pushlock pull or turn reset)	XW1E-BV4	1NC	FB1W-XW1E-BV401MRH-Y0	RH	FB1W-XW1E-BV401MRH-Y1	RH
			2NC	FB1W-XW1E-BV402MRH-Y0		FB1W-XW1E-BV402MRH-Y1	
			3NC	FB1W-XW1E-BV403MRH-Y0		FB1W-XW1E-BV403MRH-Y1	
			4NC	FB1W-XW1E-BV404MRH-Y0		FB1W-XW1E-BV404MRH-Y1	
			1N01NC	FB1W-XW1E-BV411MRH-Y0		FB1W-XW1E-BV411MRH-Y1	
			1N02NC	FB1W-XW1E-BV412MRH-Y0		FB1W-XW1E-BV412MRH-Y1	
			1N03NC	FB1W-XW1E-BV413MRH-Y0		FB1W-XW1E-BV413MRH-Y1	
			2N02NC	FB1W-XW1E-BV422MRH-Y0		FB1W-XW1E-BV422MRH-Y1	
	XW Series Emergency Stop Switches (Illuminated, LED/24V, pushlock pull or turn reset)	XW1E-LV4	1NC	FB1W-XW1E-LV401Q4MR-Y0	R	FB1W-XW1E-LV401Q4MR-Y1	R
			2NC	FB1W-XW1E-LV402Q4MR-Y0		FB1W-XW1E-LV402Q4MR-Y1	
			3NC	FB1W-XW1E-LV403Q4MR-Y0		FB1W-XW1E-LV403Q4MR-Y1	
			4NC	FB1W-XW1E-LV404Q4MR-Y0		FB1W-XW1E-LV404Q4MR-Y1	
			1N01NC	FB1W-XW1E-LV411Q4MR-Y0		FB1W-XW1E-LV411Q4MR-Y1	
			1N02NC	FB1W-XW1E-LV412Q4MR-Y0		FB1W-XW1E-LV412Q4MR-Y1	
			1N03NC	FB1W-XW1E-LV413Q4MR-Y0		FB1W-XW1E-LV413Q4MR-Y1	
XW Series Emergency Stop Switches (Push-ON LED, LED/24V, pushlock pull or turn reset)	XW1E-TV4	3NC	FB1W-XW1E-TV403Q4MR-Y0	R	FB1W-XW1E-TV403Q4MR-Y1	R	
		1N02NC	FB1W-XW1E-TV412Q4MR-Y0		FB1W-XW1E-TV412Q4MR-Y1		

Color code (*): Red (R), Bright Red (RH)

- APEM
- Switches & Pilot Lights
- Control Boxes
- Emergency Stop Switches
- Enabling Switches
- Safety Products
- Explosion Proof
- Terminal Blocks
- Relays & Sockets
- Circuit Protectors
- Power Supplies
- LED Illumination
- Controllers
- Operator Interfaces
- Sensors
- AUTO-ID
- FB

Download catalogs and CAD from <http://eu.idec.com/downloads>

C-010

FB Series Control Stations

Control Stations

1 Hole (Box Size: 76mm)

Symbol	Specification			<Without nameplate>		With nameplate "EMERGENCY" stop	
		Switch Part No.	Contact Configuration	Part No. (Ordering Part No.)	Color (*)	Part No. (Ordering Part No.)	Color (*)
	HW Series Emergency Stop Switches (Pushlock turn reset)	HW1B-V4	1NC	FB1W-HW1B-V401R-Y0	R	FB1W-HW1B-V401R-Y1	R
			2NC	FB1W-HW1B-V402R-Y0		FB1W-HW1B-V402R-Y1	
			1N01NC	FB1W-HW1B-V411R-Y0		FB1W-HW1B-V411R-Y1	
	HW Series Emergency Stop Switches (Pushlock pull reset)	HW1B-Y2	1NC	FB1W-HW1B-Y201R-Y0	R	FB1W-HW1B-Y201R-Y1	R
			2NC	FB1W-HW1B-Y202R-Y0		FB1W-HW1B-Y202R-Y1	
			1N01NC	FB1W-HW1B-Y211R-Y0		FB1W-HW1B-Y211R-Y1	
	HW Series Emergency Stop Switches (Pushlock key reset)	HW1B-X4	1NC	FB1W-HW1B-X401R-Y0	R	FB1W-HW1B-X401R-Y1	R
			2NC	FB1W-HW1B-X402R-Y0		FB1W-HW1B-X402R-Y1	
			1N01NC	FB1W-HW1B-X411R-Y0		FB1W-HW1B-X411R-Y1	

Color code (*): Red (R)

Control Stations with SEMI Emergency off (EMO) Switches

Symbol	Specification			<Without Guard>		SEMI Switchguard	
		Switch Part No.	Contact Configuration	Part No. (Ordering Part No.)	Color (*)	Part No. (Ordering Part No.)	Color (*)
 (For SEMI)	HW Series SEMI EMO Pushbutton (Pushlock turn reset)	HW1B-V4	1NC	FB1W-HW1B-V401R-EMO-Y0	R	FB1W-HW1B-V401R-EMO-Y□	R
			2NC	FB1W-HW1B-V402R-EMO-Y0		FB1W-HW1B-V402R-EMO-Y□	
			1N01NC	FB1W-HW1B-V411R-EMO-Y0		FB1W-HW1B-V411R-EMO-Y□	
	XW Series SEMI EMO Pushbuttons (Non-illuminated, pushlock pull or turn reset)	XW1E-BV4	1NC	FB1W-XW1E-BV401MRH-EMO-Y0	RH	FB1W-XW1E-BV401MRH-EMO-Y□	RH
			2NC	FB1W-XW1E-BV402MRH-EMO-Y0		FB1W-XW1E-BV402MRH-EMO-Y□	
			3NC	FB1W-XW1E-BV403MRH-EMO-Y0		FB1W-XW1E-BV403MRH-EMO-Y□	
			4NC	FB1W-XW1E-BV404MRH-EMO-Y0		FB1W-XW1E-BV404MRH-EMO-Y□	
			1N01NC	FB1W-XW1E-BV411MRH-EMO-Y0		FB1W-XW1E-BV411MRH-EMO-Y□	
			1N02NC	FB1W-XW1E-BV412MRH-EMO-Y0		FB1W-XW1E-BV412MRH-EMO-Y□	
1N03NC	FB1W-XW1E-BV413MRH-EMO-Y0	FB1W-XW1E-BV413MRH-EMO-Y□					
2N02NC	FB1W-XW1E-BV422MRH-EMO-Y0	FB1W-XW1E-BV422MRH-EMO-Y□					

Color code (*): Red (R), Bright Red (RH)

*1) Specify a code for SEMI switchguard in place of □ in the part no. (2: HW9Z-KG3, 3: HW9Z-KG4)

Control stations with HW9Z-KG3, HW9Z-KG4 are SEMI S2 compliant. For details, see D-052.

Control Stations



With HW1B-V4

With HW1B-V4 & HW9Z-KG3

With HW1B-V4 & HW9Z-KG4

With XW1E-BV4

With XW1E-BV4 & HW9Z-KG3

With XW1E-BV4 & HW9Z-KG4

FB Series Control Stations

Control Boxes

Control Stations

1 Hole (Box Size: 76mm)

Symbol	Specification	Legend		<Without nameplate>		<Optional marking plate>	
		Switch Part No.	Contact Configuration	Part No. (Ordering Part No.)	Color (*)	Part No. (Ordering Part No.)	Color (*)
PB	Pushbutton (Momentary, flush)	HW1B-M1	1NO	FB1W-HW1B-M110*-Z0	G W	FB1W-HW1B-M110*-Z1	G W
			1NO1NC	FB1W-HW1B-M111*-Z0		FB1W-HW1B-M111*-Z1	
	Pushbutton (Momentary, extended)	HW1B-M2	1NC	FB1W-HW1B-M201*-Z0	R B	FB1W-HW1B-M201*-Z1	R B
			1NO1NC	FB1W-HW1B-M211*-Z0		FB1W-HW1B-M211*-Z1	
	Pushbutton (Momentary, ø40)	HW1B-M4	1NO	FB1W-HW1B-M410*-Z0	G	FB1W-HW1B-M410G-Z1	G
			1NO1NC	FB1W-HW1B-M411G-Z0		FB1W-HW1B-M411G-Z1	

Color code (*): Black (B), Green (G), Red (R), White (W)

Symbol	Specification	Legend		With nameplate "ON"		With nameplate "START"	
		Switch Part No.	Contact Configuration	Part No. (Ordering Part No.)	Color (*)	Part No. (Ordering Part No.)	Color (*)
PB	Pushbutton (Momentary, flush)	HW1B-M1	1NO	FB1W-HW1B-M110*-Z2	G W	FB1W-HW1B-M110*-Z3	G W
			1NO1NC	FB1W-HW1B-M111*-Z2		FB1W-HW1B-M111*-Z3	
	Pushbutton (Momentary, ø40)	HW1B-M4	1NO	FB1W-HW1B-M410G-Z2	G	FB1W-HW1B-M410G-Z3	G
			1NO1NC	FB1W-HW1B-M411G-Z2		FB1W-HW1B-M411G-Z3	

Color code (*): Green (G), White (W)

Symbol	Specification	Legend		With nameplate "OFF"		With nameplate "STOP"	
		Switch Part No.	Contact Configuration	Part No. (Ordering Part No.)	Color (*)	Part No. (Ordering Part No.)	Color (*)
PB	Pushbutton (Momentary, extended)	HW1B-M2	1NC	FB1W-HW1B-M201*-Z2	R B	FB1W-HW1B-M201*-Z3	R B
			1NO1NC	FB1W-HW1B-M211*-Z2		FB1W-HW1B-M211*-Z3	

Color code (*): Black (B), Red (R)

Symbol	Specification	Switch Part No.	Legend		With "&ON/O&OFF" on Switch	
			Top Button	Bottom Button	Part No. (Ordering Part No.)	Color (*)
PB	Dual Pushbutton (Momentary, flush-extended)	HW7D-B12	1NO	1NC	FB1W-HW7D-B121001WB1-Z0	WB (Top: White / Bottom: Black)
	Dual Pushbutton (Interlock, flush-extended)		HW7D-B22	1NO	1NC	

Symbol	Specification	Legend		<Without nameplate>			
		Switch Part No.	Illuminated Voltage	Part No. (Ordering Part No.)	Color (*)	Part No. (Ordering Part No.)	Color (*)
PL	Pilot Light	HW1P-2Q (Round extended)	LED / 24V	FB1W-HW1P-2Q4*-Z0	Color 1	FB1W-HW1P-2Q4*-Z0	PW S
		HW1P-5Q (Dome)	LED / 24V	FB1W-HW1P-5Q4*-Z0	Color 1	FB1W-HW1P-5Q4*-Z0	PW S

(Color 1) R, G, A, Y

Color code (*): Red (R), Green (G), Amber (A), Yellow (Y), Pure White (PW), Blue (S)

- APEM
- Switches & Pilot Lights
- Control Boxes
- Emergency Stop Switches
- Enabling Switches
- Safety Products
- Explosion Proof
- Terminal Blocks
- Relays & Sockets
- Circuit Protectors
- Power Supplies
- LED Illumination
- Controllers
- Operator Interfaces
- Sensors
- AUTO-ID

FB

Download catalogs and CAD from <http://eu.idec.com/downloads>

C-012

FB Series Control Stations

Control Stations

1 Hole (Box Size: 76mm)

Symbol	Specification	Switch Part No.	Contact Configuration	<Without nameplate>	<Optional marking plate>
	Selector Switches (2-position maintained, knob, black)	HW1S-2T	1NO	FB1W-HW1S-2T10-Z0	FB1W-HW1S-2T10-Z1
			1NO1NC	FB1W-HW1S-2T11-Z0	FB1W-HW1S-2T11-Z1
	Selector Switches (2-position maintained, knob, key selector) (*1)	HW1K-2A	1NO	FB1W-HW1K-2A10-Z0	FB1W-HW1K-2A10-Z1
			1NO1NC	FB1W-HW1K-2A11-Z0	FB1W-HW1K-2A11-Z1

*1) Keys removable in both left and right.



Symbol	Specification	Switch Part No.	Contact Configuration	With nameplate "ON-OFF"	With nameplate "HAND-AUTO"
	Selector Switches (2-position maintained, knob, black)	HW1S-2T	1NO	FB1W-HW1S-2T10-Z2	FB1W-HW1S-2T10-Z3
			1NO1NC	FB1W-HW1S-2T11-Z2	FB1W-HW1S-2T11-Z3
	Selector Switches (2-position maintained, knob, key selector) (*1)	HW1K-2A	1NO	FB1W-HW1K-2A10-Z2	FB1W-HW1K-2A10-Z3
			1NO1NC	FB1W-HW1K-2A11-Z2	FB1W-HW1K-2A11-Z3



*1) Keys removable in both left and right.

Symbol	Specification	Switch Part No.	Contact Configuration	<Without nameplate>	<Optional marking plate>
	Selector Switches (3-position maintained, knob, black)	HW1S-3T	2NO	FB1W-HW1S-3T20-Z0	FB1W-HW1S-3T20-Z1

Symbol	Specification	Switch Part No.	Contact Configuration	With nameplate "HAND-OFF-AUTO"
	Selector Switches (3-position maintained, knob, black)	HW1S-3T	2NO	FB1W-HW1S-3T20-Z2



2 Holes (Box Size: 140mm, Mounting Centers: 50mm)



Symbol	Specification	Switch Part No.	Legend①	<Without nameplate>	<Optional marking plate>	With nameplate "ON"	With nameplate "START"
			Legend②	<Without nameplate>	<Optional marking plate>	With nameplate "OFF"	With nameplate "STOP"
①  ② 	① Pushbutton (Momentary, flush, green) ② Pushbutton (Momentary, flush, red)	HW1B-M1 HW1B-M1	1NO 1NO	FB2W-211Z-A02001	-	-	-
			1NO 1NC	FB2W-211Z-A02002	FB2W-211Z-A02003	FB2W-211Z-A02004	FB2W-211Z-A02005
			1NO1NC 1NO1NC	FB2W-211Z-A02006	FB2W-211Z-A02007	FB2W-211Z-A02008	FB2W-211Z-A02009



Symbol	Specification	Switch Part No.	Legend①	<Without nameplate>	<Optional marking plate>	With nameplate "ON"	With nameplate "START"
			Legend②	<Without nameplate>	<Optional marking plate>	With nameplate "OFF"	With nameplate "STOP"
①  ② 	① Pushbutton (Momentary, flush, white) ② Pushbutton (Momentary, flush, black)	HW1B-M1 HW1B-M1	1NO 1NO	FB2W-211Z-A02010	-	-	-
			1NO 1NC	FB2W-211Z-A02011	FB2W-211Z-A02012	FB2W-211Z-A02013	FB2W-211Z-A02014
			1NO1NC 1NO1NC	FB2W-211Z-A02015	FB2W-211Z-A02016	FB2W-211Z-A02017	FB2W-211Z-A02018



Control Stations



2 Holes (Box Size: 140mm, Mounting Centers: 50mm)



Symbol	Specification		Legend①	<Without nameplate>	<Optional marking plate>	With nameplate "ON"	With nameplate "START"
			Legend②	<Without nameplate>	<Optional marking plate>	With nameplate "OFF"	With nameplate "STOP"
①  ② 	① Pushbutton (Momentary, flush, green) ② Pushbutton (Momentary, extended, red)	HW1B-M1 HW1B-M2	Contact Configuration	Part No. (Ordering Part No.)			
			1NO 1NC	FB2W-211Z-A02019	FB2W-211Z-A02020	FB2W-211Z-A02021	FB2W-211Z-A02022
			1NO1NC 1NO1NC	FB2W-211Z-A02023	FB2W-211Z-A02024	FB2W-211Z-A02025	FB2W-211Z-A02026



Symbol	Specification		Legend①	<Without nameplate>	<Optional marking plate>	With nameplate "ON"	With nameplate "START"
			Legend②	<Without nameplate>	<Optional marking plate>	With nameplate "OFF"	With nameplate "STOP"
①  ② 	① Pushbutton (Momentary, flush, white) ② Pushbutton (Momentary, extended, red)	HW1B-M1 HW1B-M2	Contact Configuration	Part No. (Ordering Part No.)			
			1NO 1NC	FB2W-211Z-A02027	FB2W-211Z-A02028	FB2W-211Z-A02029	FB2W-211Z-A02030
			1NO1NC 1NO1NC	FB2W-211Z-A02031	FB2W-211Z-A02032	FB2W-211Z-A02033	FB2W-211Z-A02034

Symbol	Specification		Legend①	<Without nameplate>	<Optional marking plate>	With nameplate "ON"	With nameplate "START"
			Legend②	<Without nameplate>	<Optional marking plate>	With nameplate "OFF"	With nameplate "STOP"
①  ② 	① Pushbutton (Momentary, flush, white) ② Pushbutton (Momentary, ø40, black)	Switch Part No. HW1B-M1 HW1B-M4	Contact Configuration	Part No. (Ordering Part No.)			
			1NO 1NC	FB2W-211Z-A02035	FB2W-211Z-A02036	FB2W-211Z-A02037	FB2W-211Z-A02038
			1NO1NC 1NO1NC	FB2W-211Z-A02039	FB2W-211Z-A02040	FB2W-211Z-A02041	FB2W-211Z-A02042

Symbol	Specification		Legend①	<Without nameplate>
			Legend②	<Without nameplate>
①  ② 	① Pilot Light (Round extended, red) ② Pilot Light (Round extended, green)	Switch Part No. HW1P-2Q HW1P-2Q	Illuminated Voltage	Part No. (Ordering Part No.)
			LED / 24V LED / 24V	FB2W-211Z-A02043

Symbol	Specification		Legend①	<Without nameplate>	<Without nameplate>	<Without nameplate>
			Legend②	<Without nameplate>	<Optional marking plate>	With nameplate "STOP"
①  ② 	① Pilot Light (Round extended, red) ② Pilot Light (Momentary, extended, black)	Switch Part No. HW1P-2Q HW1B-M2	Illuminated Voltage Contact Configuration	Part No. (Ordering Part No.)		
			LED / 24V 1NO1NC	FB2W-211Z-A02045	FB2W-211Z-A02046	FB2W-211Z-A02047

Symbol	Specification		Legend①	<Without nameplate>	<Without nameplate>	<Without nameplate>
			Legend②	<Without nameplate>	<Optional marking plate>	With nameplate "HAND-AUTO"
①  ② 	① Pilot Light (Round extended, red) ② Selector Switch (2-position maintained, knob, black)	Switch Part No. HW1P-2Q HW1S-2T	Illuminated Voltage Contact Configuration	Part No. (Ordering Part No.)		
			LED / 24V 1NO1NC	FB2W-211Z-A02048	FB2W-211Z-A02049	FB2W-211Z-A02050

Symbol	Specification		Legend①	<Without nameplate>	<Without nameplate>	<Without nameplate>
			Legend②	<Without nameplate>	<Optional marking plate>	With nameplate "HAND-AUTO"
①  ② 	① Pilot Light (Round extended, red) ② Selector Switch (*1) (2-position maintained, key selector)	Switch Part No. HW1P-2Q HW1K-2A	Illuminated Voltage Contact Configuration	Part No. (Ordering Part No.)		
			LED / 24V 1NO1NC	FB2W-211Z-A02051	FB2W-211Z-A02052	FB2W-211Z-A02053

*1) Keys removable in both left and right.

- APEM
- Switches & Pilot Lights
- Control Boxes
- Emergency Stop Switches
- Enabling Switches
- Safety Products
- Explosion Proof
- Terminal Blocks
- Relays & Sockets
- Circuit Protectors
- Power Supplies
- LED Illumination
- Controllers
- Operator Interfaces
- Sensors
- AUTO-ID

FB

 Download catalogs and CAD from <http://eu.idec.com/downloads>

C-014

FB Series Control Stations

Control Stations

3 Holes (Box Size: 140mm, Mounting Centers: 30mm)

Symbol Specification	Switch Part No.	Contact Configuration	Part No. (Ordering Part No.)	
			Legend①	Legend②
 ① Pushbutton (Momentary, flush, green) ② Pushbutton (Momentary, flush, red) ③ Pushbutton (Momentary, flush, green)	HW1B-M1 HW1B-M1 HW1B-M1	1NO 1NC 1NO	<Without nameplate>	<Optional marking plate>
			<Without nameplate>	<Optional marking plate>
			<Without nameplate>	<Optional marking plate>
			FB2W-312Z-A03001	FB2W-312Z-A03002

Symbol Specification	Switch Part No.	Contact Configuration	Part No. (Ordering Part No.)	
			Legend①	Legend②
 ① Pushbutton (Momentary, flush, white) ② Pushbutton (Momentary, flush, red) ③ Pushbutton (Momentary, flush, black)	HW1B-M1 HW1B-M1 HW1B-M1	1NO 1NC 1NO	<Without nameplate>	<Optional marking plate>
			<Without nameplate>	<Optional marking plate>
			<Without nameplate>	<Optional marking plate>
			FB2W-312Z-A03003	FB2W-312Z-A03004

Symbol Specification	Switch Part No.	Illuminated Voltage Contact Configuration	Part No. (Ordering Part No.)			
			Legend①	Legend②	Legend③	Legend④
 ① Pilot Light (Round extended, red) ② Pushbutton (Momentary, flush, red) ③ Pushbutton (Momentary, extended, black)	HW1P-2Q HW1B-M1 HW1B-M2	LED / 24V 1NO 1NC	<Without nameplate>	<Without nameplate>	<Without nameplate>	<Without nameplate>
			<Without nameplate>	<Optional marking plate>	With nameplate "ON"	With nameplate "START"
			<Without nameplate>	<Optional marking plate>	With nameplate "OFF"	With nameplate "STOP"
			FB2W-312Z-A03005	FB2W-312Z-A03006	FB2W-312Z-A03007	FB2W-312Z-A03008

3 Holes (Box Size: 200mm, Mounting Centers: 50mm)

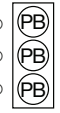

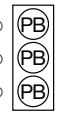
Symbol	Specification	Switch Part No.	Contact Configuration	Part No. (Ordering Part No.)	
				Legend①	Legend②
 ① Pushbutton (Momentary, flush, green) ② Pushbutton (Momentary, flush, red) ③ Pushbutton (Momentary, flush, green)		HW1B-M1 HW1B-M1 HW1B-M1	1NO 1NC 1NO	<Without nameplate>	<Optional marking plate>
				<Without nameplate>	<Optional marking plate>
				<Without nameplate>	<Optional marking plate>
				FB3W-311Z-A03009	FB3W-311Z-A03010
			1NO1NC 1NO1NC 1NO1NC	FB3W-311Z-A03011	FB3W-311Z-A03012

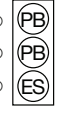

Symbol	Specification	Switch Part No.	Contact Configuration	Part No. (Ordering Part No.)	
				Legend①	Legend②
 ① Pushbutton (Momentary, flush, white) ② Pushbutton (Momentary, flush, red) ③ Pushbutton (Momentary, flush, black)		HW1B-M1 HW1B-M1 HW1B-M1	1NO 1NC 1NO	<Without nameplate>	<Optional marking plate>
				<Without nameplate>	<Optional marking plate>
				<Without nameplate>	<Optional marking plate>
				FB3W-311Z-A03013	FB3W-311Z-A03014
			1NO1NC 1NO1NC 1NO1NC	FB3W-311Z-A03015	FB3W-311Z-A03016



Symbol	Specification	Switch Part No.	Contact Configuration	Part No. (Ordering Part No.)		
				Legend①	Legend②	Legend③
 ① Pushbutton (Momentary, flush, white) ② Pushbutton (Momentary, flush, black) ③ Emergency Stop Switch (Pushlock turn reset)		HW1B-M1 HW1B-M2 HW1B-V4	1NO 1NC 2NC	<Without nameplate>	With nameplate "ON"	With nameplate "START"
				<Without nameplate>	With nameplate "OFF"	With nameplate "STOP"
				<None> (with yellow blank nameplate)	With nameplate "EMERGENCY-STOP"	With nameplate "EMERGENCY-STOP"
				FB3W-311Z-A03017	FB3W-311Z-A03018	FB3W-311Z-A03019



Control Stations

3 Holes (Box Size: 140mm, Mounting Centers: 30mm)

Symbol	Specification		Legend ①	<Without nameplate>	With nameplate "ON"	With nameplate "START"
			Legend ②	<Without nameplate>	With nameplate "OFF"	With nameplate "STOP"
			Legend ③	<None> (with yellow blank nameplate)	With nameplate "EMERGENCY-STOP"	With nameplate "EMERGENCY-STOP"
			Switch Part No.	Contact Configuration	Part No. (Ordering Part No.)	
①  ②  ③ 	① Pushbutton (Momentary, flush, white) ② Pushbutton (Momentary, extended, black) ③ Emergency Stop Switch (Pushlock pull or turn reset)	HW1B-M1 HW1B-M2 XW1E-BV4	1N01NC 1N01NC 2NC	FB3W-311Z-A03020	FB3W-311Z-A03021	FB3W-311Z-A03022
			1N01NC 1N01NC 1N02NC	FB3W-311Z-A03026	FB3W-311Z-A03027	FB3W-311Z-A03028

Symbol	Specification		Legend ①	<Without nameplate>	With nameplate "ON"	With nameplate "START"
			Legend ②	<Without nameplate>	With nameplate "OFF"	With nameplate "STOP"
			Legend ③	<None> (with yellow blank nameplate)	With nameplate "EMERGENCY-STOP"	With nameplate "EMERGENCY-STOP"
			Switch Part No.	Illuminated Voltage Contact Configuration	Part No. (Ordering Part No.)	
①  ②  ③ 	① Pushbutton (Momentary, flush, white) ② Pushbutton (Momentary, extended, black) ③ Emergency Stop Switch (Illuminated type) (Pushlock pull or turn reset)	HW1B-M1 HW1B-M2 XW1E-LV4	2NC/LED/24V 1N01NC 1N01NC	FB3W-311Z-A03023	FB3W-311Z-A03024	FB3W-311Z-A03025
			1N02NC/LED/24V 1N01NC 1N01NC	FB3W-311Z-A03029	FB3W-311Z-A03030	FB3W-311Z-A03031

Symbol	Specification		Legend ①	<Without nameplate>	<Without nameplate>	<Without nameplate>	<Without nameplate>
			Legend ②	<Without nameplate>	<Optional marking plate>	With nameplate "ON"	With nameplate "START"
			Legend ③	<Without nameplate>	<Optional marking plate>	With nameplate "OFF"	With nameplate "STOP"
			Switch Part No.	Illuminated Voltage Contact Configuration	Part No. (Ordering Part No.)		
①  ②  ③ 	① Pilot Light (Round extended, red) ② Pushbutton (Momentary, flush, white) ③ Pushbutton (Momentary, extended, black)	HW1P-2Q HW1B-M1 HW1B-M2	LED / 24V 1NO 1NC	FB3W-311Z-A03032	FB3W-311Z-A03033	FB3W-311Z-A03034	FB3W-311Z-A03035
			LED / 24V 1N01NC 1N01NC	FB3W-311Z-A03036	FB3W-311Z-A03037	FB3W-311Z-A03038	FB3W-311Z-A03039

Symbol	Specification		Legend ①	<Without nameplate>	<Optional marking plate>	With nameplate "ON"	With nameplate "START"
			Legend ②	<Without nameplate>	<Optional marking plate>	With nameplate "OFF"	With nameplate "STOP"
			Legend ③	<Without nameplate>	<Optional marking plate>	With nameplate "HAND-AUTO"	With nameplate "HAND-AUTO"
			Switch Part No.	Contact Configuration	Part No. (Ordering Part No.)		
①  ②  ③ 	① Pushbutton (Momentary, flush, white) ② Pushbutton (Momentary, flush, black) ③ Selector Switch (2-position, knob, black)	HW1B-M1 HW1B-M2 HW1S-2T	1NO 1NC 1NO	FB3W-311Z-A03041	FB3W-311Z-A03042	FB3W-311Z-A03044	FB3W-311Z-A03043
			1N01NC 1N01NC 1N01NC	FB3W-311Z-A03045	FB3W-311Z-A03046	FB3W-311Z-A03048	FB3W-311Z-A03047

- APEM
- Switches & Pilot Lights
- Control Boxes
- Emergency Stop Switches
- Enabling Switches
- Safety Products
- Explosion Proof
- Terminal Blocks
- Relays & Sockets
- Circuit Protectors
- Power Supplies
- LED Illumination

- Controllers
- Operator Interfaces
- Sensors
- AUTO-ID

FB



Download catalogs and CAD from <http://eu.idec.com/downloads>

C-016

FB Series Control Stations

Control Stations

4 Holes (Box Size: 200mm, Mounting Centers: 36mm)

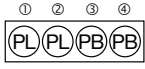
Symbol Specification			Legend①	<Without nameplate>	<Without nameplate>	<Without nameplate>
			Legend②	<Without nameplate>	<Without nameplate>	<Without nameplate>
 <p>① Pilot Light (Round extended, red) ② Pilot Light (Round extended, green) ③ Pushbutton (Momentary, flush, white) ④ Pushbutton (Momentary, extended, black)</p>	Switch Part No.	Illuminated Voltage Contact Configuration	Part No. (Ordering Part No.)			
		HW1P-2Q HW1P-2Q HW1B-M1 HW1B-M2	LED / 24V LED / 24V 1NO1NC 1NO1NC	FB3W-413Z-A04001	FB3W-413Z-A04002	FB3W-413Z-A04003

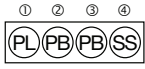
Symbol Specification			Legend①	<Without nameplate>	<Without nameplate>	<Without nameplate>
			Legend②	<Without nameplate>	<Optional marking plate>	<Without nameplate>
 <p>① Pilot Light (Round extended, red) ② Pushbutton (Momentary, flush, white) ③ Pushbutton (Momentary, extended, black) ④ Selector Switch (2-position maintained, knob, black)</p>	Switch Part No.	Illuminated Voltage Contact Configuration	Part No. (Ordering Part No.)			
		HW1P-2Q HW1B-M1 HW1B-M2 HW1S-2T	LED / 24V 1NO1NC 1NO1NC 1NO1NC	FB3W-413Z-A04004	FB3W-413Z-A04005	FB3W-413Z-A04006

5 Holes (Box Size: 200mm, Mounting Centers: 30mm)

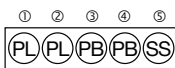
Symbol Specification			Legend①	<Without nameplate>	<Without nameplate>	<Without nameplate>
			Legend②	<Without nameplate>	<Without nameplate>	<Without nameplate>
 <p>① Pilot Light (Round extended, red) ② Pilot Light (Round extended, green) ③ Pushbutton (Momentary, flush, white) ④ Pushbutton (Momentary, extended, black) ⑤ Selector Switch (2-position maintained, knob, black)</p>	Switch Part No.	Illuminated Voltage Contact Configuration	Part No. (Ordering Part No.)			
		HW1P-2Q HW1P-2Q HW1B-M1 HW1B-M2 HW1S-2T	LED / 24V LED / 24V 1NO1NC 1NO1NC 1NO1NC	FB3W-512Z-A05001	FB3W-512Z-A05002	FB3W-512Z-A05003

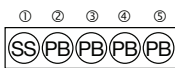
Symbol Specification			Legend①	<Without nameplate>
			Legend②	<Without nameplate>
 <p>① Selector Switch (2-position maintained, knob, black) ② Pushbutton (Momentary, flush, green) ③ Pushbutton (Momentary, flush, green) ④ Pushbutton (Momentary, flush, green) ⑤ Pushbutton (Momentary, flush, green)</p>	Switch Part No.	Contact Configuration	Part No. (Ordering Part No.)	
		HW1S-2T HW1B-M1 HW1B-M1 HW1B-M1 HW1B-M1	1NO 1NO 1NO 1NO 2NO	FB3W-512Z-A05004

⚠ Safety Precautions

- Turn off power before installation, removal, maintenance, and inspection. Failure to turn power off may cause electrical shocks or fire hazard.
- To avoid burning your hand, use the lamp holder tool when replacing the lamps.

Instructions

Installation

Panel Mounting

1. Installing the FB series from the front

- Using two M4 screws, install the base onto the panel.
- Recommended tightening torque: 1.4 to 2.0 N·m
- Determine the screw length in consideration of the base and panel thickness.
- Mounting screws are not supplied with the FB series. Use M4 mounting screws.

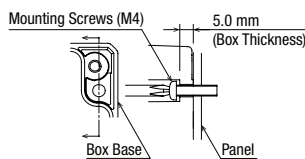

2. Installing the FB series from the rear

- Insert four M4 tapped screws into holes for tapping screws on the back of the base (depth: 8 to 10 mm, tapping screw hole diameter: $\varnothing 3.7$ mm), and fasten the screws to a tightening torque of 1.3 ± 0.1 N·m (Nitto Seiko M4-P-TITE).
- Mounting screws are not supplied with the FB series. Use M4 tapping screws (recommended screws: Nitto Seiko M4-P-TITE).
- The value of the recommended tightening torque has been confirmed with a M4 tapping screw (Nitto Seiko M4-P-TITE). When using other screws, check that the tapping screw hole is not damaged and the screw can be securely tightened.

3. Installation using mounting bracket FB9Z-PK1

- Refer to installation instructions on **C-020**.

Installing and Removing the Switch/Pilot Light

- Refer to installation instructions for each unit.

Installing the Cable Gland

- Break a desired knockout using a hammer and a screwdriver, and install the cable gland.
- When breaking the knockout to make a cable gland hole, be careful not to damage the internal contact block.
- Note that cracks or burrs on the cable gland hole will degrade the waterproof characteristics.

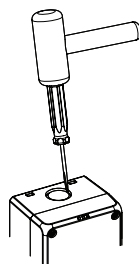

Installing the Cover and Base

- Attach the cover to the base so that the TOP mark on the cover and base are in the same direction.
- Use cover mounting screws to attach the cover to the base. (Recommended tightening torque: 1.3 ± 0.1 N·m)
- Make sure that the cover and the base are attached in the correct direction. Otherwise, the FB series may be damaged.

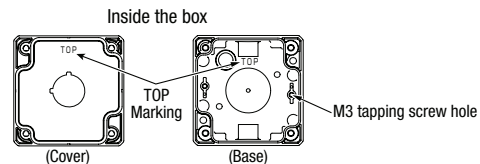

Installation using tapping screw hole inside the enclosure

- When using M3 tapping hole screws inside the enclosure, make sure to install the devices in consideration of the insulation distance and temperature rise. Damages caused by using devices other than those specified by IDEC are excluded from any warranty. Ensures installed with devices using tapping screw holes will not be UL or c-UL listed.
- M3 tapping screw hole (depth: 6 to 7mm, tapping screw hole diameter $\varnothing 2.7$ mm)
- Recommended tightening torque: 0.9 ± 0.1 N·m, M3-P-TITE (Nitto Seiko)

Applicable Crimping Terminal

HW/TW Series

Non-insulated Terminal

Crimping terminal from ①

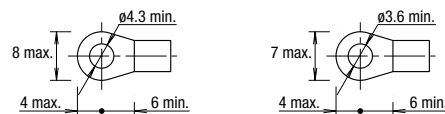

IP20 terminal

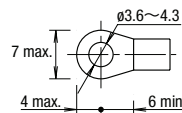

Crimping terminal from ②

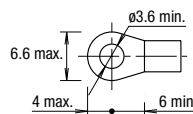

Dimensions for installing insulated tube

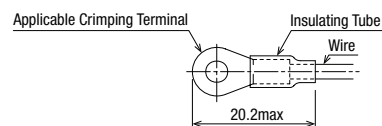

- See HW series catalog pages for applicable crimping terminals.

Wiring Directions

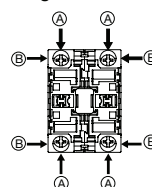

 Download catalogs and CAD from <http://eu.idec.com/downloads>

FB Series Control Stations

Instructions

XW Series (Screw Terminal)

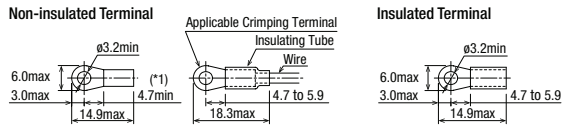

APEM

Switches & Pilot Lights

Control Boxes

Emergency Stop Switches
Enabling Switches

Safety Products

Explosion Proof

Terminal Blocks

Relays & Sockets

Circuit Protectors

Power Supplies

LED Illumination

Controllers

Operator Interfaces

Sensors

AUTO-ID

- *1) When a spade terminal is used, the dimension is 4.7 to 5.9 mm.
- * Be sure to install an insulating tube on the crimping terminal.
- * When using crimping terminals for the XW series, use only one crimping terminal for each terminal.
- * Make sure that the wiring does not contact the control stations.

Applicable Cable Gland

- Use cable glands with waterproof characteristics (IP65, TYPE 4X) which can be mounted on a panel thickness of 3 mm or more.

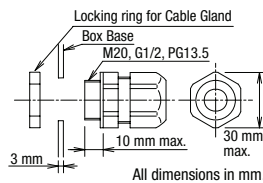

- * Cable gland and Locking nuts are not attached.

1) When using flexible conduits (Example)

Flexible conduits: VF-03 (Made by Nippon Flex Co., Ltd.)

Gland Port Size	Plastic Cable Gland	Metal Cable Gland
M20		RLC-103EC20 (Nippon Flex)
G1/2		RLC-103 (Nippon Flex)
PG13.5		RBC-103PG13.5 (Nippon Flex)

When using multi-core cables (Example)

Gland Port Size	Plastic Cable Gland	Metal Cable Gland
M20	5311 1220 [Skintop-ST-M] Applicable gasket: GPM20 (LAPP, Germany)	ALS-□□EC20 (Nippon Flex)
G1/2	5380 6030 [Skintop-ST-PF] Applicable gasket: GP 050 (LAPP, Germany)	ALS16-□□ (Nippon Flex)
PG13.5	5301 5030 [Skintop-ST] Applicable gasket: GP13.5 (LAPP, Germany)	ABS-□□PG13.5 (Nippon Flex)

3) Locking ring for cable gland (plastic, optional)

Gland Port Size	Locking Nut Part No. (made of plastic)
M20	HW9Z-NM20 (IDEC)
G1/2	HW9Z-G (IDEC)
PG13.5	HW9Z-PG135 (IDEC)

- The degree of protection of the cable gland examples described above is not NEMA TYPE 4X.
- When using the FB series in North America, be sure to use UL approved plastic cable glands.
- Tighten cable glands to a torque of 3.0 ± 0.3 N·m.
 - * Insufficient tightening of the cable gland may degrade the waterproof characteristics.
 - * Electric shock protection Class II is maintained only when a plastic cable gland is used.
- Determine the cable gland for a multi-core cable according to the outside diameter of the cable sheath.
- When wiring from the back of FB series, use the $\phi 14$ knockout on the back of the enclosure. A cable gland cannot be installed to the $\phi 14$ knockout.

Notes

Applicable Wire Size

- Determine the wire size in consideration of the applicable wire for switches/pilot lights and the applicable diameter of cables.

Wiring

- Avoid foreign objects such as dust, liquid, and oil from entering the switch while connecting a conduit or wiring.
- Do not twist or pull the cable of flexible conduit with excessive force. Otherwise, the wire, FB series, and switches/pilot lights may be damaged.
- Because the FB series is not provided with a PG terminal, bonding circuits cannot be interconnected.

Installation of switches/pilot lights on 30 mm centers

- When mounting HW/TW series control units on 30mm mounting centers (close mounting), make sure to use a barrier (optional: HW-VU1) to secure the insulation properties of the terminal. The barriers (HW-VU1) can be easily pressed into the side of the contact block.

Operation

- Avoid any contact with oil or coolants. Otherwise, the FB series may be damaged.
- Use the FB series for INDOOR applications only.

Contact Cover Box

Specifications, applicable units, and wiring

- Same as the standard control stations.

Installing XW series to the FB1WR-111Z contact cover

- Remove the contact block and the locking ring from the operator and check that the rubber gasket is in place. Insert the operator from panel front into the panel hole. Attach the rubber gasket and the base to the operator unit (place the rubber gasket between the panel and the base) and tighten the locking ring using locking ring wrench MW9Z-T1. Recommended tightening torque: 2.0 N·m
- Attach the contact block to the operator. After wiring, attach the cover to the base using four cover mounting screws. Recommended tightening torque: 1.3 ± 0.1 N·m
- Use a nameplate if necessary.
- Determine the panel thickness by excluding the thickness of the base (2.0 mm) and accessories (if used) from the maximum panel thickness for the switch/pilot light.

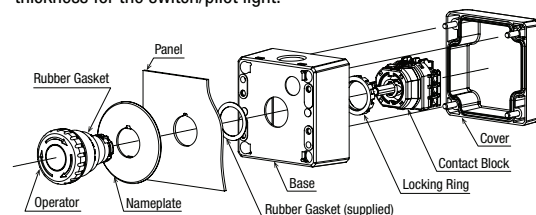

Notes

- Do not expose the cable to excessive force, otherwise failure or damage may be caused. When mounting strength is needed, insert M4 tapping screws from the front of the panel (screw tightening depth: 8 to 10 mm tapping screw hole: $\phi 3.7$ mm)
- Determine the mounting hole centers referring to the dimensions of the control stations.

Instructions

Mounting Bracket

Hook Mounting

- Attach the FB9Z-PK1 mounting bracket on the FB series with the supplied screws (two M4 tapping screws).
Recommended tightening torque: 1.3 ± 0.1 N·m
- Do not tighten the FB9Z-PK1 onto the FB series with excessive force. The tapping screw hole may be damaged and may not securely hold the FB series.

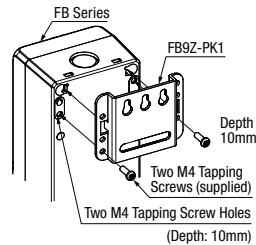

1) Hook Mounting

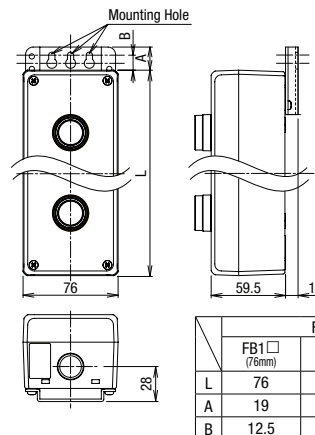

Frame Mounting

- The FB9Z-PK1 can be used as frame mounting brackets by attaching two FB9Z-PK1 as shown below.

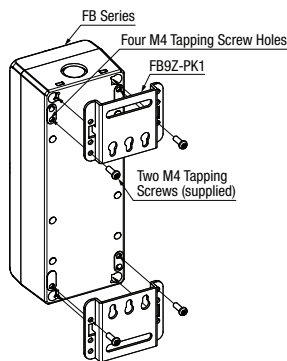

2) Frame Mounting

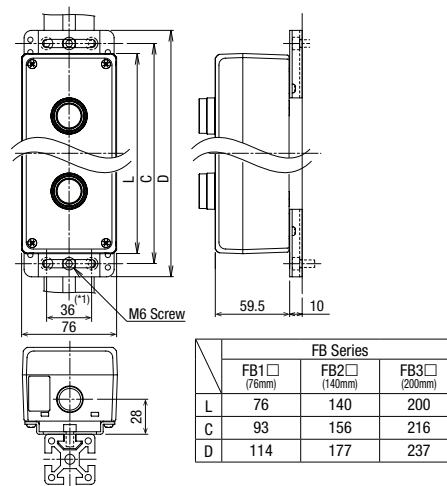

- Attach the FB9Z-PK1 on the FB series with the supplied screws (two M4 tapping screws).
Recommended tightening torque: 1.3 ± 0.1 N·m.
- Do not tighten the FB9Z-PK1 onto the FB series with excessive force. The tapping screw hole may be damaged and may not securely hold the control station.
- Using two M6 screws, fasten the FB9Z-PK1 securely on the frame.
Recommended tightening torque: 5.0 ± 0.3 N·m

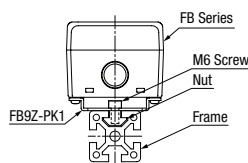

- M6 mounting screws and nuts are not supplied with the FB9Z-PK1.
- The value of the recommended tightening torque for M6 screws has been confirmed with a hexagon socket head screw. When other screws are used and tightened to a smaller torque, make sure that the screws do not become loose after mounting.

Dimensions

All dimensions in mm.

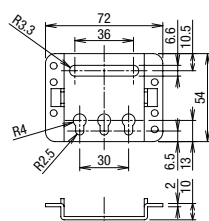

 Download catalogs and CAD from <http://eu.idec.com/downloads>

- APEM
- Switches & Pilot Lights
- Control Boxes
- Emergency Stop Switches
- Enabling Switches
- Safety Products
- Explosion Proof
- Terminal Blocks
- Relays & Sockets
- Circuit Protectors
- Power Supplies
- LED Illumination
- Controllers
- Operator Interfaces
- Sensors
- AUTO-ID

FB Series Control Stations

Instructions

DIN Rail Adapter

Mounting

1) Installing the FB9Z-PK3 DIN Rail Adapter

- To attach the FB9Z-PK3 on the FB series, position the positioning hole of the FB9Z-PK3 with the positioning boss in the enclosure using four M3 tapping screws (supplied) as shown in the figure below. Recommended tightening torque: 0.9 ± 0.1 N-m
- Do not tighten the FB9Z-PK3 onto the FB series with excessive force. The tapping screw hole may be damaged and may not securely hold the control station.

2) Installing the DIN Rail

- To attach a DIN rail, use plain washers and spring washers on two M5 screws and tighten firmly. Recommended tightening torque: 2.0 ± 0.1 N-m
- DIN rail mounting screw (M5)
Screw length: (spring washer thickness + plain washer thickness + DIN rail thickness) + 3 to 5 mm

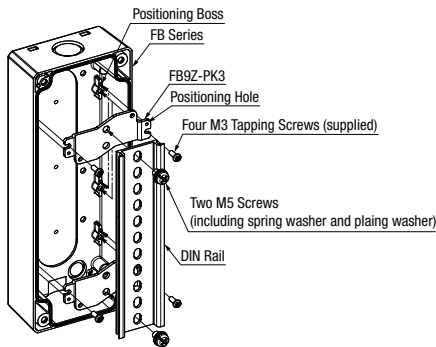

- M5 screws, spring washers, and plain washers are not supplied.
- The length of DIN rail must be within the effective internal dimensions.
- Do not tighten the M5 screw onto the FB9Z-PK3 with excessive force. The screw hole may be damaged and may not securely hold the FB9Z-PK3.

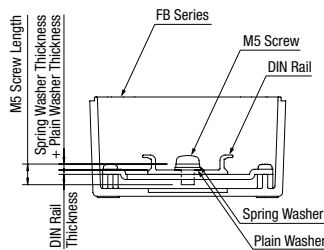

3) Mounting Switches/Pilot Lights on DIN Rail

- Refer to each instruction sheet.

4) Installing the Separate Mounting Transformer

- After attaching the FB9Z-PK3 on the FB series, attach the separate mounting transformer on the FB9Z-PK3, using plain washers and spring washers on two M3 screws as shown in the figure below. Recommended tightening torque: 0.5 to 0.8 N-m
- Separate mounting transformer mounting screw (M3)
Screw Length: (Spring washer thickness) + (Plain washer thickness) + 7 to 10 mm

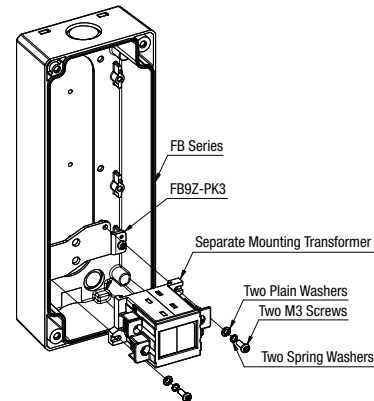

- M3 screws, spring washers, and plain washers are not supplied.
- Do not tighten the screw with excessive force. The screw hole and the separate mounting transformer may be damaged.

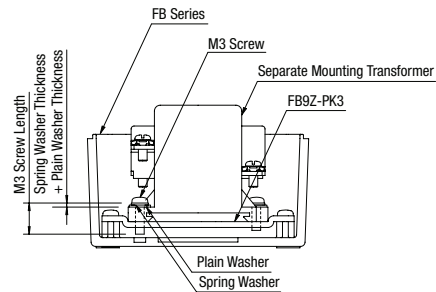

FB9Z-PK3 Dimensions

All dimensions in mm.

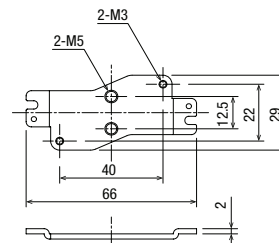

Instructions

Inside Dimensions of FB Series

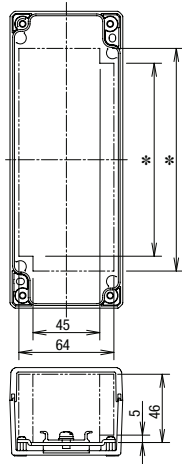

FB9Z-PK3 Installation Positions

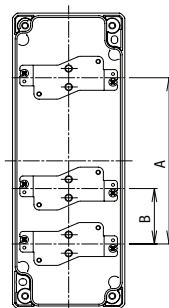

FB Series Enclosure		
	FB2□ (140mm)	FB3□ (200mm)
A	50	112.5
B	—	37.5

* See internal dimensions on C-008.

Note: Only one DIN rail adapter can be used for FB1□ (76mm).

5) Other Precautions

- Rated current of terminal blocks depends on operating conditions such as wire type, number of bundle wires, and ambient temperature. Check the specifications of terminal blocks carefully, and use terminal blocks within the specification values. Otherwise electric shock or fire hazard may be caused.
- FB series is rated as Class II protection against electric shock (no reliance on installation protective measures, according to IEC 61140). When using a blank front enclosure as a junction box and grounding is necessary, provide appropriate grounding, for example installing a grounding terminal block inside the enclosure.
- For wiring, refer to the instructions of the FB series and switches/pilot lights used.

APEM

Switches & Pilot Lights

Control Boxes

Emergency Stop Switches
Enabling Switches

Safety Products

Explosion Proof

Terminal Blocks

Relays & Sockets

Circuit Protectors

Power Supplies

LED Illumination

Controllers

Operator Interfaces

Sensors

AUTO-ID

FB



Download catalogs and CAD from <http://eu.idec.com/downloads>

C-022