

Spring Clamp Relay Sockets

SU Series



Can be installed easily on 35-mm-wide DIN rail in snap-on action.



• See website for details on approvals and standards.

Wiring time reduced by 50%

Wiring reduced by 50% compared with standard screw terminals. (compared with IDEC products)

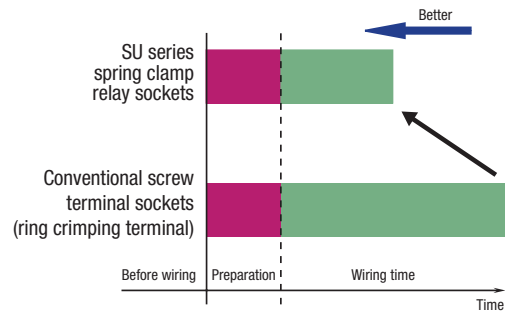

Finger-safe IP20 degree of protection

Finger-safe IP20 degree of protection (IEC 60529)
Prevents electric shock by protection from live parts.

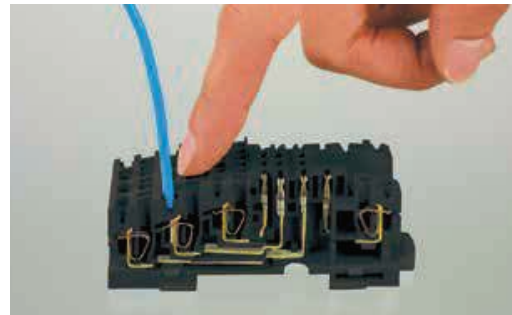

Easy connection using jumper wiring

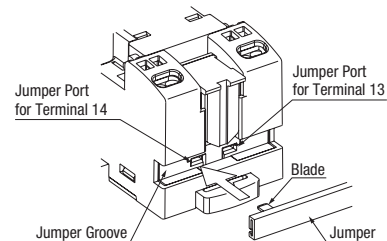

Safe and reliable

Relay contact terminals on upper side and coil terminal on the lower provide higher safety and allows easy wiring. Spring clamp style connection achieves high contact reliability and vibration resistance regardless of wire size and shape.



Reduced maintenance

Spring clamp eliminates loosening, reducing maintenance and labor.

SU Series Spring Clamp Relay Sockets

New spring-clamp relay socket providing higher level of safety.

Relay Sockets

Shape	No. of Poles	Part No.	Applicable Relay
	2	SU2S-11L	RU2S RM2S GT5Y-2
	4	SU4S-11L	RU4S, RY4S, RY42S, GT5Y-4

Specifications

Part No.		SU2S-11L	SU4S-11L
Operating Temperature		-55 to +70°C (no freezing)	
Operating Humidity		45 to 85% RH (no condensation)	
Storage Temperature		-55 to +70°C (no freezing)	
Storage Humidity		45 to 85% RH (no condensation)	
Applicable Wire	EN/IEC	Solid Wire	0.2 to 1.5mm ²
		Stranded Wire	0.2 to 1.25mm ²
	UL	AWG24-16	
Rated Insulation Voltage		250V	
Rated Current (Note)		10A 8A (collective mounting)	6A (4-pole) 10A (2-pole) 8A (2-pole, collective mounting)
Dielectric Strength		Between contacts of the different poles: 2500V AC, 1 min. (between live and dead metal parts, between live metal parts of the different poles)	
Insulation Resistance		100MΩ minimum	
Degree of Protection		IP20 (IEC 60529)	
Weight (approx.)		53g	63g

Note: When operating over the rated current in collective mounting, keep 10mm between the SU sockets.

Dimensions

SU2S-L/SU4S-11L

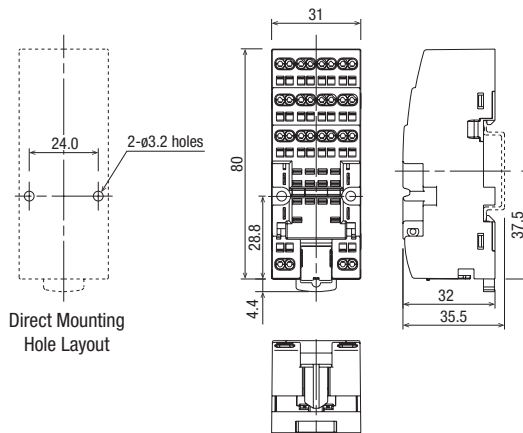

Terminal Arrangement (top view)

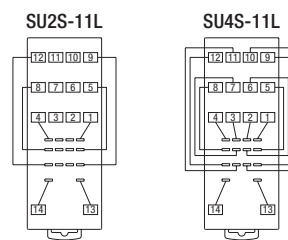

Relays & Sockets

- APEM
- Switches & Pilot Lights
- Control Boxes
- Emergency Stop Switches
- Enabling Switches
- Safety Products
- Explosion Proof
- Terminal Blocks
- Relays & Sockets
- Circuit Protectors
- Power Supplies
- LED Illumination
- Controllers
- Operator Interfaces
- Sensors
- AUTO-ID
- Relays
- Sockets
- DIN Rail Products

SJ

DF

SU

S

 Download catalogs and CAD from <http://eu.idec.com/downloads>

H-052

SU Series Spring Clamp Relay Sockets

Accessories

All dimensions in mm
When ordering, specify the Ordering No.

Name	Shape	Specifications	Part No.	Ordering No.	Package Quantity	Remarks
Jumper		Brass (ABS cover) Weight: 3g (approx.)	SU9Z-J5	SU9Z-J5PN10	10	Used for interconnecting relay coil terminals. Can be cut to required length.
Hold-down Spring (leaf spring)		Stainless steel Weight (a pair): 1g (approx.)	SFA-101	SFA-101PN20	10 pairs	A pair of springs are used for a relay.
		Stainless steel Weight (a pair): 2g (approx.)	SFA-202	SFA-202PN20	10 pairs	
DIN Rail (*1)		Aluminum Weight: 200g (approx.)	BAA1000	BAA1000PN10	10	Length: 1m Width: 35mm
		Steel Weight: 320g	BAP1000	BAP1000PN10	10	
End Clip (*1)		Metal (zinc plated steel) Weight: 15g (approx.)	BNL6	BNL6PN10	10	

Note: Make sure that the total current to the jumper does not exceed the rated current.

*1) See H-071 for details on DIN rail products

Instructions

Identifying Socket

SU2S-11L and SU4S-11L can be identified by the part number marked on the side. Note that 4-pole relay cannot be mounted on SU2S.

No. of Poles	Part No.
2	SU2S-11L
4	SU4S-11L

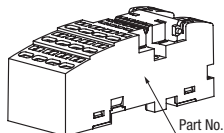

Applicable Wires

- Strip the wire insulation 9 to 10 mm from the end.
- When using stranded wires without ferrules, make sure that the core wires have not been loosened.

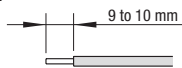

- In applications using ferrules for stranded wires, choose the ferrule listed in the table below. Make sure that an insulation sheath is applied when using the ferrules. When using thin wires with insulation diameter of $\phi 1.6$ mm or less, do not insert the wire too deeply where the insulation inserts into the

spring clamp opening. Make sure that the wire insulation is stripped 9 to 10 mm and the wire is inserted to the bottom.

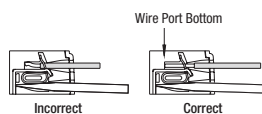

Applicable Ferrules

Applicable Wire (stranded)	Part No.	Manufacturer
mm ²	AWG	
0.25	24	AI 0.25-12BU
—	22	AI 0.34-8TQ
0.5	20	AI 0.5-8WH
		AI 0.5-10WH

Phoenix Contact

Applicable Screwdriver

For wiring, use the following applicable screwdriver.

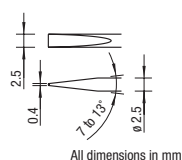

Parts Description

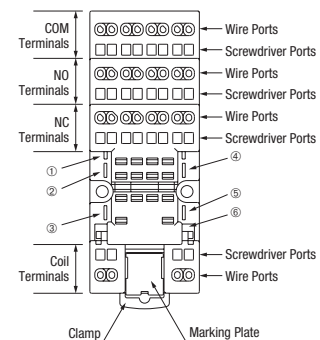

①②⑤⑥: Spring slots for SFA-101 leaf springs
③④③⑤: Spring slots for SFA-202 leaf springs

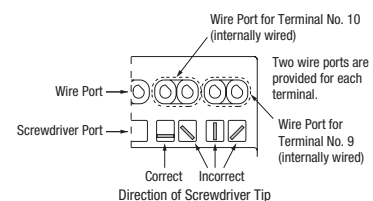

SU Series Spring Clamp Relay Sockets

Relays & Sockets

Instructions

Wiring Instructions

1. Insert an applicable screwdriver into the square-shaped port as shown, until the screwdriver tip touches the bottom of the spring.

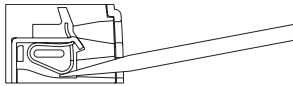

2. Push in the screwdriver until it touches the bottom of the port. The wire port is now open, and the screwdriver is held in place. The screwdriver will not come off even if you release your hand.



3. While the screwdriver is retained in the port, insert the wire or ferrule into the round-shaped wire port. Each wire port can accommodate one wire or ferrule. When connecting two wires to one terminal, use the adjoining port of the same terminal.



4. Pull out the screwdriver. The connection is now complete.

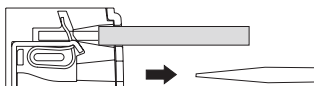

Do not tilt or turn the screwdriver while it is inserted into the screwdriver port in the socket, otherwise the socket may break.

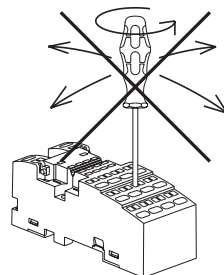

Installing the Hold-down Spring

Use SFA-101 or SFA-202 hold-down spring (ordered separately). To install, insert the springs into the spring slots with the projection on the springs facing each other. Once installed, the springs cannot be removed.

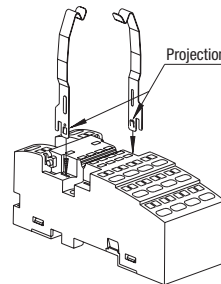

SFA-101 Leaf Spring

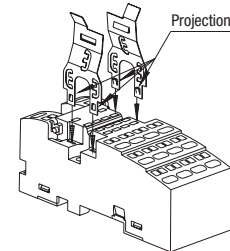

SFA-202 Leaf Spring

Installing the Marking Plate

Because of its removable structure, the marking plate may have fallen from the socket or become loose in delivery. Make sure that the marking plate is securely installed before starting operation. The marking plate protects the conductive portion of the socket, located under the marking plate, by preventing metal fragments or pieces of wire from dropping inside. Should any such fragments enter the socket, they may cause fire hazard, damage, or malfunction.

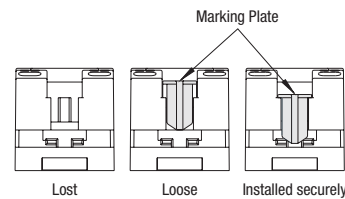

Marking Plate

Write markings on the SU sockets using an oil-based marker, or glue printed mylar on the marking surface. The size of the printed mylar can be 8 × 9 mm maximum.

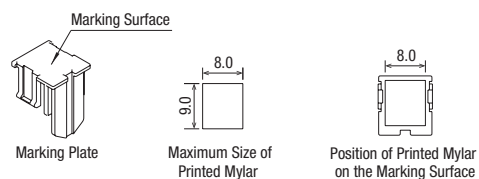

DIN Rail Mounting and Removing

Mounting

With the latch facing downward, install the socket on the DIN rail as shown below.

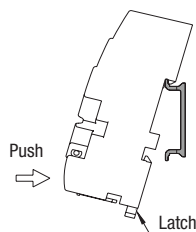

Removing

Pull the latch with a hand or using a screwdriver, and remove the socket from the DIN rail.

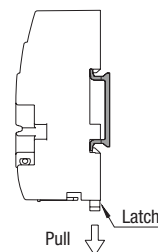

Do not mount or remove the socket at -20°C or below.

- APEM
- Switches & Pilot Lights
- Control Boxes
- Emergency Stop Switches
- Enabling Switches
- Safety Products
- Explosion Proof
- Terminal Blocks
- Relays & Sockets
- Circuit Protectors
- Power Supplies
- LED Illumination
- Controllers
- Operator Interfaces
- Sensors
- AUTO-ID

- Relays
- Sockets
- DIN Rail Products

- SJ
- DF
- SU
- S

Download catalogs and CAD from <http://eu.idec.com/downloads>

H-054

SU Series Spring Clamp Relay Sockets

Installing the SU9Z-J5 Jumper

Loosen the marking plate on the socket. Making sure that the SU9Z-J5 jumper is correctly aligned, insert the blades into the ports in the groove of the SU socket.

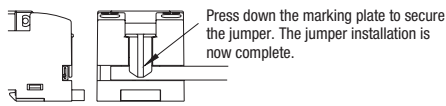
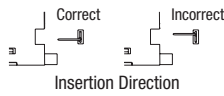
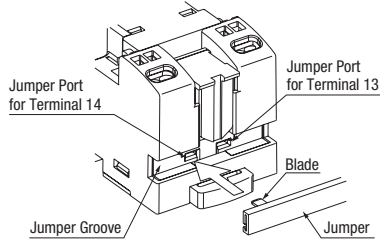

Jumper Wiring to Six or More SU Sockets

To jumper wire six or more SU sockets, connect five sockets using whole jumpers and the remaining sockets using a cut jumper. Then connect the two terminals on adjoining sockets using an applicable wire (see table below).

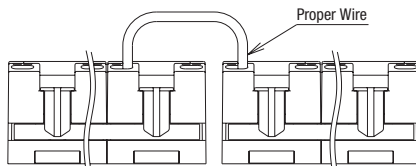

Jumper Wiring of Terminal 14 between Adjoining Sockets

Installing the SU9Z-J5 Jumper on Two, Three, or Four SU Sockets

As shown below, slide the jumper in the sheath so that the jumper aligns with the center of the sheath.

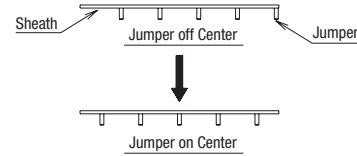

With the sheath properly installed on the jumper, cut the sheath and jumper at the points shown below, using cutting pliers. Referring to the drawing on the below right, make sure that the sheath and jumper are cut within the cutting area. Dispose of unused portions according to local waste disposal requirements.

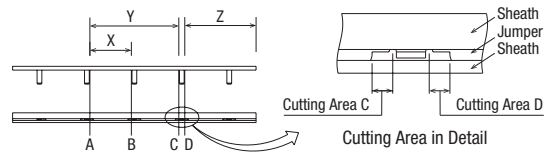

For Connecting	Jumper Quantity	Cutting Area	Discard
2 sockets	2	A, C	Y
2 sockets	1		X
3 sockets	1	A, B	
4 sockets	1	D	Z

After cutting the jumper and sheath, slide the jumper as shown below, so that the ends of the jumper are not exposed.

